

Experimentally supported mathematical modeling of continuous baking processes

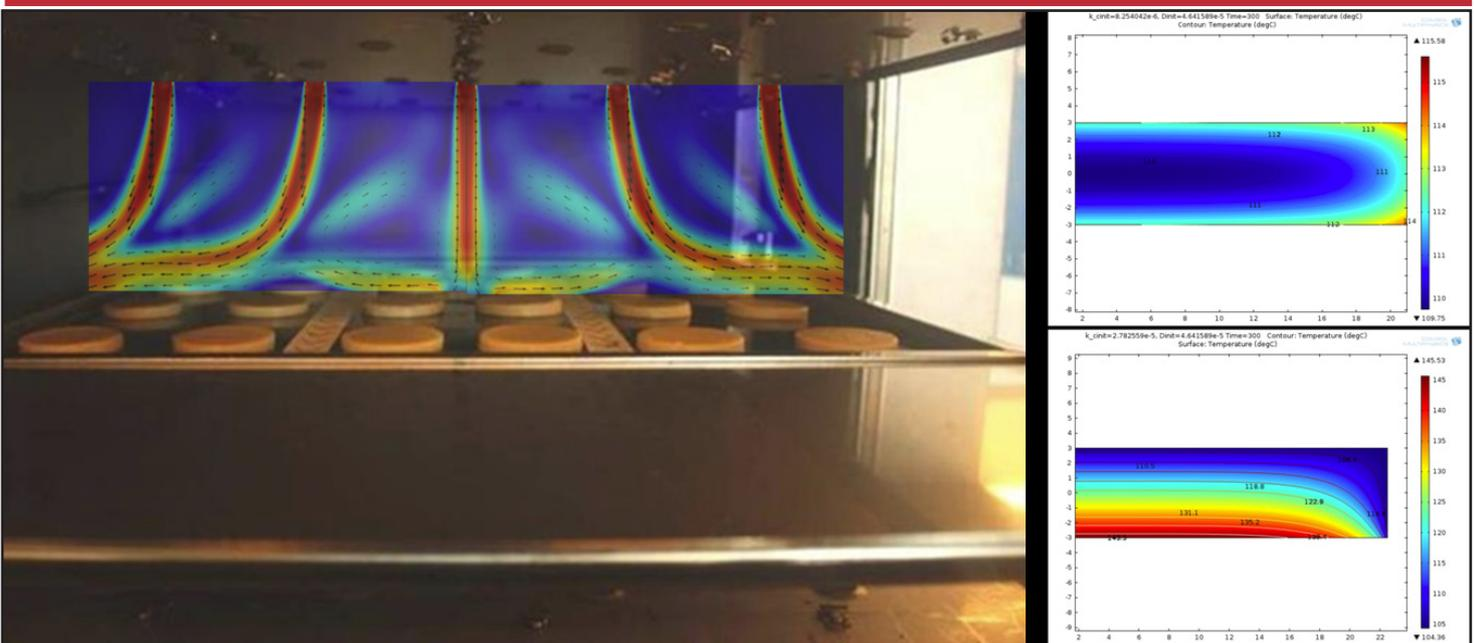

Mette Stenby Andresen
 PhD Thesis
 2013

Experimentally supported mathematical modeling of continuous baking processes

Mette Stenby Andresen
PhD Thesis

Division of Industrial Food Research
National Food Institute
Technical University of Denmark

June 2013

Supervisors

Professor, dr.techn. Jens Adler-Nissen, Division of Industrial Food Research
Assistant professor, PhD Hanne Løje, Division of Industrial Food Research

Preface

This thesis is based on research carried out as a PhD project at the Division of Industrial Food Research, National Food Institute at the Technical University of Denmark, from December 15, 2008, to June 20, 2013. The overall scope of the research has been to investigate the influence of industrial baking process conditions on the quality of bakery products.

The PhD project is part of a larger project supported by the Danish Ministry of Food, Agriculture and Fisheries titled “*Continuous baking: New opportunities for control of product quality in the tunnel ovens of the future for the bakery industry*”¹. Financial support was granted in March 2009 under the Innovation Law with the project number: 3414-08-02280.

The PhD project was prolonged for a total of eight months due to leaves of absence. These periods were primarily used to plan and teach the advanced DTU course “hygienic design i the food industry” in the fall of 2010 and 2011.

It is my hope that the present work will help the bakery industry, oven manufacturers, and researchers in future studies of the effect of oven conditions on bakery product quality.

Mette Stenby Andresen
June 2013

¹DK title: *Kontinuerlig bagning: Nye muligheder for styring af produktkvalitet i fremtidens tunnelovne til bageriindustrien*

Acknowledgments

I am very grateful to my supervisors professor, dr.techn. Jens Adler-Nissen and assistant professor, PhD Hanne Løje. Your advice, help, ideas, and support have been invaluable throughout this project.

Through the good collaboration with Haas-Meincke A/S I have had the pleasure of working with many friendly and competent people. Especially I would like to thank Kjeld Rasmussen, Brian Nielsen, and Lars Guldager. I greatly appreciate how you have supported my project and helped whenever needed.

In some aspects associate professor Jørgen Risum has supported my project as an additional supervisor. His incredible knowledge of everything related to food technology and photography has saved the day more than once. For valuable discussions of modeling, equations, and simulations I thank my good colleague Dr. Aberham Hailu Feyissa, and his thesis on heat and mass transfer in solid foods is highly recommended for further reading. Thanks to all my colleagues in the Division I, and especially the FPE group, for a positive and supportive atmosphere. I am thankful to Peter Stubbe for his invaluable technical assistance with the oven.

My family has been the most encouraging and loving support I could ever wish for. Annie, Erling, Peter, and Henrik I love you and appreciate all your help throughout my life, and this project. Special thanks to Hanne Andresen for proof reading the manuscript.

I would like to thank Løgumkloster Refugium for supporting my work through a week of immersion and contemplation. For financial support I thank the Danish Ministry of Food, Agriculture and Fisheries.

Summary

The scope of the PhD project was to increase knowledge on the process-to-product interactions in continuous tunnel ovens. The work has focused on five main objectives. These objectives cover development of new experimental equipment for pilot plant baking experiments, mathematical modeling of heat and mass transfer in a butter cookie product, and evaluation of quality assessment methods.

The pilot plant oven is a special batch oven designed to emulate continuous convection tunnel oven baking. The design, construction, and validation of the oven has been part of the project and is described in this thesis. The oven was successfully validated against a 10 m tunnel oven. Besides the ability to emulate the baking conditions in a tunnel oven, the new batch oven is designed and constructed for experimental research work. In the design options to follow the product continuously (especially weight and temperature) and control the process (air flow, temperature, and humidity) are therefore emphasized. The oven is furthermore designed to work outside the range of standard tunnel ovens, making it interesting for manufacturers of both baking products and baking equipment.

A mathematical model describing the heat and mass transfer in butter cookies during baking was formulated. The model was solved numerically by the use of a finite element method. Model optimization and validation was successfully carried out against experimental data obtained in the new pilot plant oven. The effect of the baking tray on mass transfer was examined through comparison of different modeling set-ups and experimental data. It was found that while the baking tray is likely to reduce the evaporation from the bottom surface, it is not correct to assume that no evaporation takes place at the covered surface.

Parallel to the construction of the pilot oven an advanced multi-spectral imaging method was investigated as a method for quality assessment of butter cookies. The ability of the method to assess multiple quality aspects from one image was the main focus of the study. The system was able to predict both the surface browning and the water content in butter cookies.

Resumé

Det grundlæggende formål med ph.d.-projektet har været at undersøge proces-til-produkt interaktioner i kontinuerte tunnelovne. Arbejdet i projektet har været centreret omkring fem primære målsætninger. Disse omfatter udvikling af en ny eksperimentel pilot plant ovn, matematisk modellering af energi- og massetransport i et småkageprodukt samt evaluering af metoder til kvalitetsbestemmelse af småkager.

Pilot plant ovnen er en batchovn specielt bygget til at efterligne kontinuert konvektionsbaking i tunnelovne. Design, konstruktion og validering af ovnen var en del af projektet og er beskrevet i denne afhandling. Ovnen blev succesfuldt valideret mod en 10 m tunnelovn. Udover ovnens evne til at efterligne bagebetingelserne i en tunnelovn er den designet og bygget til brug i forskningsforsøg. Der er derfor lagt stor vægt på at produktet kan følges kontinuert (især vægt og temperatur), samt at processen kan kontrolleres og varieres (luftflow, temperatur og fugtighed). Ovnen er desuden bygget til at fungere uden for det normale procesvindue for den undersøgte type af tunnelovne.

En matematisk model der beskriver energi- og massetransport i en småkage er blevet udviklet. Modellen er løst numerisk med en finite element metode. Optimering og validering af modellen blev udført ved brug af eksperimentelle måleresultater fra den nye pilot plant ovn. Bagepladens effekt på fordampning i småkager blev undersøgt gennem forskellige modelleringsopsætninger og sammenligninger med data fra pilot plant ovnen. Undersøgelserne viste at selvom bagepladen ser ud til at mindske fordampningen fra undersiden af småkagen, er det ikke korrekt at antage at den forhindrer al fordampning fra denne overflade.

Foruden udviklingen af den nye pilot plant ovn blev en avanceret multi-spektral billedeanalysemetode undersøgt med henblik på kvalitetsbestemmelse af småkager. Metodens evne til at bestemme flere kvalitetsparametre fra et billede var det primære fokus i denne undersøgelse. Metoden viste sig at kunne forudsige både overfladebruning og vandindholdet i de undersøgte småkager.

Contents

List of symbols	1
1 Introduction	3
1.1 Scientific contributions	5
1.2 Structure of the PhD thesis	7
2 Background and hypothesis	9
2.1 Industrial baking ovens - from batch to continuous production	9
2.1.1 The investigated oven type	10
2.2 Bakery products	11
2.2.1 Investigated product groups	12
2.3 State of the art	14
2.3.1 Heat and mass transfer modeling	14
2.3.2 Laboratory and pilot scale ovens for research and model validation .	18
2.3.3 State of the art summary	22
2.4 Project hypotheses	25
3 Mechanistic description of baking processes	27
3.1 Ingredients and dough preparation	27
3.2 The baking process	29
3.2.1 Bread baking	29
3.2.2 Biscuit baking	32
3.3 Complexity and modeling	33
4 Quality assessment methods for bakery products	35
4.1 Objective quality assessment	35
4.1.1 Quality assessment methods in academic literature	36

4.1.2	Evaluation of physical dimensions	37
4.1.3	Evaluation of appearance	38
4.1.4	Texture evaluation	39
4.1.5	Product composition	40
4.2	Choosing assessment methods for the present work	40
4.3	Multi-spectral image analysis as a quality assessment method	43
4.4	Summary for assessment methods	45
5	Design and construction of a specialized batch oven	47
5.1	The general design of the batch oven	49
5.2	Process control	49
5.2.1	Temperature measurements	49
5.2.2	Heating systems	51
5.2.3	Air humidity	54
5.3	The inlet air flow	55
5.4	Product monitoring	58
5.4.1	Product weight	58
5.4.2	Product temperature	59
5.4.3	Visual inspection	59
5.5	Summary of oven design	60
6	Validation of the batch oven	61
6.1	Quality parameters for the validation experiments	61
6.2	Uniform heating and baking in the batch oven	63
6.2.1	Estimating the heat transfer coefficient	63
6.2.2	Baking experiments for uniform browning	66
6.2.3	Results for heating and baking uniformity	67
6.3	Comparison between batch and tunnel ovens	68
6.3.1	Results of comparative experiments	69
6.4	Influence of inlet air velocity on butter cookies quality	71
6.4.1	Experimental work	71
6.4.2	Results and discussion	72
6.5	Summary of validation	73
7	Mathematical-physical models and model parameters	77

7.1	Heat and mass transfer	77
7.1.1	Heat transfer	78
7.1.2	Mass transfer	80
7.2	Parameters for the simulations	82
7.2.1	Product properties	82
7.2.2	Water transport and evaporation	85
7.2.3	Process properties	87
8	Numerical solution of heat and mass transfer equations	89
8.1	Numerical solution methods	89
8.1.1	Finite element method	90
8.2	Present approach	90
8.2.1	Geometry	91
8.2.2	Meshing	93
8.2.3	Water evaporation and temperature	93
8.2.4	Assumptions and simplifications	94
8.3	Simulation results and validation	95
8.3.1	Experiments for validation	95
8.3.2	Initial simulations	97
8.3.3	Improving simulation results by optimizing the mass transfer and diffusion coefficients	98
8.4	Discussion of the numerical simulations	102
9	Influence of the baking tray on heat and mass transfer	105
9.1	Optimized coefficients	107
9.2	Simulation results and comparisons	108
9.3	Model and prediction	112
9.4	Summary	116
10	Discussion	119
10.1	Product and quality assessment methods	119
10.2	Construction and validation of the new batch oven	120
10.3	Modeling butter cookie baking	122
10.3.1	Modeling results	123
11	Conclusions	125

12 Future perspectives	127
Bibliography	128
Appendices	141
A Article: Quality assessment of butter cookies applying multi-spectral imaging	143
B Abstract and poster: A mechanistic approach to baking process-product interactions	153
C Poster: Design and construction of a batch oven for investigation of industrial continuous baking processes	157
D Article: Design and construction of a batch oven for investigation of industrial continuous baking processes	159
E Abstract: Investigating the influence of air velocity on the quality of butter cookies	171
F Abstract: Investigation of uneven mass transfer in butter cookies combining experimental work and finite element modeling	173
G Literature search for state of the art articles	191
G.1 Search targeted towards mathematical modeling in bakery products	191
G.2 Search for experimental ovens	192
H Literature review for quality assessment	193
I ANOVA testing influence of air flow	195
J Parameters and variables for COMSOL simulations	199

Symbol	Description	Unit
A	Area	m ²
a*	Color coordinate (red/green)	-
a _w	Water activity	-
b*	Color coordinate (blue/yellow)	
Bi	Biot number	
c _p	Specific heat	J/(kg·K)
D	Diffusion coefficient	m ² /s
D	Diameter	m
k _T	Thermal conductivity	W/(m·K)
k _c	Mass transfer coefficient	m/s
h _T	Heat transfer coefficient	W/(m ² ·K)
L*	Lightness (0 - 100)	-
m	Mass	kg
M	Molar weight	kg/mole
\bar{n}	Normal direction	m
r	Radial direction	m
R	Radius	m
Re	Reynold's number	-
t	Time	s
T	Temperature	K or °C
V	Volume	m ³
x	Mass fraction	kg/kg
X	Water concentration, wet basis	kg _w /kg _{product}
Y	Water concentration, dry basis	kg _w /kg _{dry matter}
z	Vertical direction	m
ε	Error	-
μ	Viscosity	Pa·s
ρ	Density	kg/m ³
Subscripts		
s	Surrounding	
0	Initial	
w	Water	
a	Air	
av	Average	
Abbreviations		
CFD	Computational Fluid Dynamics	
CIE	Commission Internationale d'Eclairage	
FDM	Finite difference method	
FEM	Finite element method	
FVM	Finite volume method	
SD	Standard deviation	

Chapter 1

Introduction

Baking is one of the oldest known methods for food processing. Over time the products and design of ovens have changed, but the basic combinations of chemical and physical processes, induced by heat transfer and transforming dough into bakery products, are still of great importance to food manufactures and researchers. Although the individual transition processes taking place during baking are well understood, the design of industrial baking processes is still highly empirical today.

According to oven manufacturers and the baking industry an important limitation for technology development is incomplete knowledge of the connections between product quality and the physical environment in the oven chamber during baking¹. Improved quantitative understanding of the connections between process and product properties will create a more rational foundation for future oven design and process control. This again will open new opportunities for development and optimization of industrial continuous baking processes and ovens.

The presented research on baking processes is to a large extent based on mathematical modeling. It is the hope that mathematical models will enable manufacturers of baking equipment and bakery products to develop more cost efficient production processes. Better understanding of the process-to-product interactions improves process control and planning. This will result in fewer discarded products, reduced energy consumption, and hopefully better product quality. Clarifying connections between processing conditions and formation of undesired by-products is also the basis for reducing the formation of undesirable components such as acrylamide (Jensen et al., 2008).

One of the top priorities for equipment manufactures and end users alike, is to decrease energy consumption in food production processes. Baking, a process with high energy consumption, is no exception. Better understanding of the baking processes and the product development during baking, will help improve energy efficiency in the production process.

¹Based on personal communications with staff at Haas-Meincke A/S and Lantmännen Unibake.

Before applying mathematical models for prediction and optimization it is important that they are adequately validated against representative experimental data. Such data can be difficult to come by, when the focus of the models is large scale industrial processes. Experimental work is difficult to carry out in full scale industrial ovens and will require much energy and product waste. Pilot scale equipment is of great value for model development and process understanding, especially if it is constructed to reproduce the baking conditions in industrial ovens and allows for product monitoring.

The initial goals of the present PhD project were to develop pilot equipment for advanced baking experiments and establish descriptive mathematical models of the heat and mass transfer processes during continuous baking. The combination of experimental work and mathematical models should then result in computer simulations of the investigated baking process. The formulations of the project goals and the design of an advanced pilot oven were conducted in collaboration with one of the world's leading manufacturers of bakery equipment, Haas-Meincke A/S, Skovlunde, Denmark. The motivation for initiating the entire project was Haas-Meincke A/S' aspiration to learn more about the interactions between baking processes and product quality.

The PhD project is a core part of a larger research project, "*Continuous baking: New opportunities for control of product quality in the tunnel ovens of the future for the bakery industry*"², for which financial support was granted in March 2009 by the Ministry of Food, Agriculture and Fisheries of Denmark. Haas-Meincke A/S contributed to the project with their vast knowledge and great experience within the field, along with the mechanical construction of a new pilot oven. The oven is designed to emulate continuous baking processes, focusing on the convective system found in Haas Meincke A/S' convection tunnel ovens, and allows for continuous monitoring of the product during baking. The oven is furthermore constructed to allow for experimental work outside the normal ranges of the industrial ovens, enabling explorative experiments regarding processing conditions and oven design.

The delivery of the pilot oven was initially planned in the fall of 2009. Unfortunately the production was affected by the global financial crisis and severely delayed. The pilot oven did not arrive at DTU until the beginning of 2011, and was not fully functional until the spring of 2011. Combined with my 4 months' leave of absence in the fall of 2011 less than a year was available for validation and experimental work with the new oven.

The severe delay of the pilot oven resulted in some restructuring of the PhD project. Initial experimental work was carried out in an existing standard convection oven. One purpose of the initial work was to investigate different quality assessment methods for bakery products. This work resulted in a journal article investigating the effect of the baking conditions using image analysis as the primary quality assessment method. The presented work expands the area of the project into the field of methods applied when assessing the product quality. The original plan for the experimental work in the pilot

²DK title: *Kontinuertlig bagning: Nye muligheder for styring af produktkvalitet i fremtidens tunnelovne til bageriindustrien*

oven included investigations of several products and investigations of a range of baking conditions. Because of the delay and subsequent problems with the pilot oven, the experimental work was limited to one product and an initial series of experiments with varying baking conditions. The selected product is a butter cookie, belonging to the biscuit group of products. It is a simple, representative product for the group. It has a light surface enabling browning evaluation, no additives such as nuts, chocolate, or different flour types, allowing for easy evaluation of the heating and drying processes during baking. Similar to the major part of biscuit products it is a thin product undergoing the basic transitions from moist dough to a finished, dry product with a long shelf-life seen for standard biscuit products, as described later in this thesis.

The modeling work performed in this project is validated against experiments in the pilot oven, and experimental data from the pilot oven is used to examine and improve the mathematical model. The proposed model is in accordance with the current state of the art for heat and mass transfer modeling of the investigated type of products.

1.1 Scientific contributions

The PhD project has resulted in several scientific contributions that are communicated in the form of this PhD thesis, journal articles, and conference presentations. To date one journal article has been published, a second is accepted for publication, and a third manuscript is submitted for publication. Additionally work has been presented at three conferences, twice as poster presentations and once as an oral presentation. All presentations were given by me, and I am also the first or the only author on the manuscripts. The contributions, other than the thesis, are described by topic in the following.

Based on the initial work performed in a standard kitchen batch oven a research study was carried out to investigate the possibilities of using multi-spectral imaging for quality evaluation of bakery products. The work was conducted in collaboration with another PhD student showing the validity of applying advanced imaging analysis in the field of bakery production. In the study it was found that multi-spectral imaging is applicable as a method to evaluate the surface browning of butter cookies and simultaneously estimate the water content. An initial form of the work was presented as a technical report in the PhD thesis by Dr. Bjørn S. Dissing. Subsequently a manuscript was written based on the technical report including re-calculations of some of the results. The idea behind the study and the work was carried out in collaboration, as can be seen by the co-author statement. The resulting manuscript "Quality Assessment of Butter Cookies Applying Multi-spectral Imaging", was accepted for publication in *Food Science & Nutrition*, April 21, 2013, and published online June 12, 2013. The latest version of the manuscript is available in Appendix A.

Prior to the arrival of the new pilot oven, further work was performed regarding mechanisms in baking of bread products. The results were presented as a poster at the 2010

Food Factory conference, Gothenburg, Sweden, July 2010. The title of the poster was "A mechanistic approach to baking process-product interactions". The study investigated the influence of water vapor and oven temperature during the initial part of baking, on the center temperature of bread rolls. Through experimental work it was shown that if water vapor is introduced in the initial phase of bread roll baking, comparable products are obtained with initial oven temperatures of 140°C and 220°C. The water vapor was exhausted after 3 minutes at which point the oven temperature was set of 180° for the remaining 17 minutes of baking. The submitted abstract and final poster are included as Appendix B.

The design of the new pilot oven, including a few initial validation experiments, was presented as a poster and short conference article at the 11th International Congress on Engineering and Food, Athens, Greece, May 2011. Later, the conference article was extended, introducing additional validation work and experiments, to a full journal article. The oven was designed and constructed with the main purpose of emulating continuous, convection tunnel ovens. The main focus is on the complex convective system, and enabling of continuous product and process monitoring during baking. The main monitoring options include visual access, air and product temperatures, product weight, and the air humidity. The air flow and the baking process were validated against a tunnel oven, using butter cookies as the test product. The manuscript, "Design and Construction of a Batch Oven for Investigation of Industrial Continuous Baking Processes", was accepted for publication in the *Journal of Food Process Engineering* on January 17, 2013. The presented poster is shown in Appendix C and the early-view version of the journal article is included as Appendix D.

One of the main features of the pilot oven is the option to vary the inlet air velocity. Results from investigation of this feature were presented as an oral presentation at the Conference of Food Engineering, Leesburg, VA, USA, April 2012. The presentation was rewarded with the Graduate Student Presentation Award at the conference. The study is considered an additional validation of the functionality of the new pilot oven, showing that it is possible to experimentally detect variations in mass transfer and browning rates when changing the air velocity in the batch oven. The abstract from the conference is found as Appendix E.

The latest results from mathematical modeling of heat and mass transfer in butter cookies, combined with experimental validation applying the pilot oven, are presented in the manuscript "Investigation of uneven mass transfer in butter cookies combining experimental work and finite element modeling". The manuscript has been submitted for publication in *International Journal of Food Engineering*, June 17, 2013. Focus is on the influence of the baking tray on the evaporation during baking. Different modeling scenarios for the evaporation across the product surfaces were examined and compared to experimental data. Of the three investigated scenarios the best agreements were found when assuming either a limited, but not inhibited, evaporation from the bottom surface, or complete mass transfer symmetry for all boundaries. The assumption of no evaporation from the bottom

surface did not provide an acceptable simulation result. The manuscript is included as Appendix F.

1.2 Structure of the PhD thesis

The thesis is divided into a number of chapters which are grouped by topic. The topics are either introductory, linked to one or more of the basic objectives for the project, or part of the final project discussion and conclusion.

Chapters 1 to 3: These chapters introduce the reader to the field of the PhD project. The first chapter is a general introduction to the project. The second chapter includes an introduction to baking ovens, bakery products, and a section describing state of the art for heat and mass transfer modeling in baking products and experimental equipment for model validation and advanced baking experiments. The third chapter covers a mechanistic description of the main changes in bakery products during baking.

Chapter 4: The chapter is concerned with quality assessment methods. The chapter covers a literature study of methods applied in research to evaluate the quality of bakery products and a study from the present PhD work evaluating a new method for quality assessment of butter cookies. The new quality assessment method is further described in the article included as Appendix A. Chapter 4 is related to the fifth objective listed in Section 2.4.

Chapters 5 and 6: These chapters describe a new experimental batch oven, designed and constructed to emulate continuous baking processes. Chapter 5 describes the design of the oven, and Chapter 6 the validation of the oven. These chapters are considered an elaboration on the article found in Appendix D. These chapters are related to the first and second objectives listed in Section 2.4.

Chapters 7 to 9: Focus in these three chapters is modeling of heat and mass transfer in a cookie product during baking in a forced convection oven. In Chapter 7 the model is explained. In Chapter 8 the applied method for numerical solving is explained and simulation results presented. Chapter 9 extends the model to include the effect of the baking tray on the evaporation during baking, additional results are presented in this chapter. Parts of all three chapters are included in the submitted manuscript shown in Appendix F. The chapters are related to the third and fourth objectives listed in Section 2.4.

Chapters 10 to 12: These three chapters summarize and conclude the thesis. The main results are reviewed and discussed in Chapter 10. The project conclusion is found in Chapter 11, and future perspectives for the presented work are described in Chapter 12.

Chapter 2

Background and hypothesis

2.1 Industrial baking ovens - from batch to continuous production

Baking is the main transition step in the production of bakery products. In the oven the dough is transformed from raw dough to the final edible product. This section gives a short summary of the development in oven design, mainly industrial continuous ovens, up to today.

The first ovens were holes dug in the ground and heated by coal or warm stones. The food to be prepared (meat or bread) was placed in the hole and left to roast or bake. From this actual oven constructions were invented. Over time the construction material has changed starting with clay ovens and ovens made from hollow rocks, to ovens build from bricks or iron, the latter was especially popular in the 19th century (Pomeranz and Shellenberger, 1971).

While baking is an old craft, the application of continuous oven systems is a fairly new invention. Until the introduction of continuous ovens, all baking processes were batch operations: Dough is placed in a heated area and then removed after a certain amount of time as a final product. An example of a batch oven for large scale industrial production from the American company Baker Perkins (1892) is shown in Figure 2.1(a) (Perkins, 2012).

With the increased level of automation following the industrial revolution, ovens were optimized to accommodate the wish for continuous bakery products. Though the first British continuous oven in 1810 was not a great success, the continuous oven was the standard in British biscuit bakeries from the middle of the 19th century (Manley, 2011). In the first continuous ovens the bakery product was transported on individual trays carried through the oven by a chain system (traveling plate ovens). These traveling ovens were somewhat similar to the idea in reel ovens, which were the standard in the USA until the 1930s. In the reel oven trays are rotated inside a big oven chamber, an illustration is

shown in Figure 2.1(b) (Pomeranz and Shellenberger, 1971).

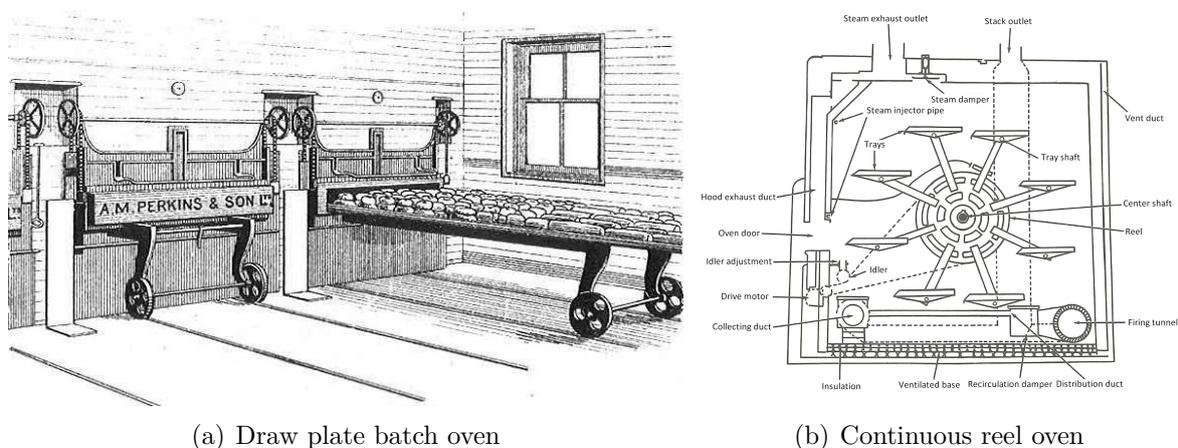

Figure 2.1: (a) A batch oven, in form of a draw plate oven from the manufacturer Baker Perkins 1892 (Perkins, 2012). (b) A continuous reel oven where the product is rotated in one big oven chamber (Pomeranz and Shellenberger, 1971).

During the 1950s rolled steel bands became available substituting the individual trays and resulting in longer and wider tunnel ovens. Some ovens today are longer than 100 m and wider than 4 m (Manley, 2011; Haas Meincke A/S, 2012).

Today three main groups of continuous ovens are produced. The choice of oven type mainly depends on the produced product. The oven types are: Directly fired ovens, indirectly fired radiation ovens, and forced convection ovens (either directly or indirectly heated).

In directly fired ovens gas or oil flames inside the oven chamber heat the product by radiation and natural convection. Indirectly fired radiation ovens are equipped with panels or tubes through which heated air is circulated thus baking the products by radiation and natural convection. In the forced convection ovens hot air passes over the product at a high air velocity controlled by a ventilator system.

Many continuous ovens are build as tunnels, which are separated into zones. In each zone the temperature and humidity are controlled individually. It is possible to build ovens that comprise different zone types. For example, cream biscuits need a high initial temperature, where after the temperature can be decreased. For this a directly fired zone could be used followed by indirectly heated zones (Mowbray, 1981).

2.1.1 The investigated oven type

The ovens in focus for this work are indirectly heated, forced convection tunnel ovens. These ovens are comprised of zones, to increase the control over the baking environment. A schematic illustration of one zone from an indirectly heated, forced convection oven

is shown in Figure 2.2. This is the type of tunnel oven used in the experimental work described in this thesis.

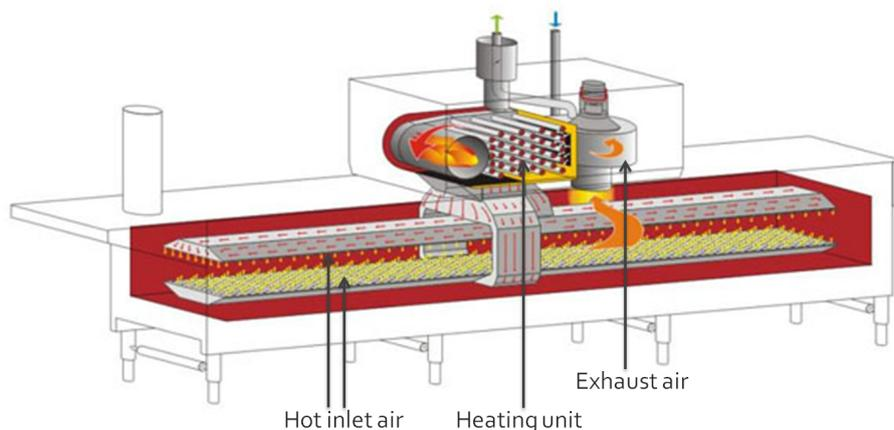

Figure 2.2: Schematic illustration of one zone of an indirectly fired convection oven. The baking band would be between the inlet air ducts but is not included in the illustration (Haas Meincke A/S, 2012).

The air is heated indirectly by passing hot tubes and then distributed above and below the baking band through round nozzels (Haas Meincke A/S, 2012). Each zone has 700 inlet nozzels above and below the baking band, and the target inlet air velocity is given to 12 m/s by the manufacturer. It is possible to adjust the inlet air distribution between the top and bottom air ducts, controlling the degree of top or bottom heating. A benefit of indirectly fired convection ovens is that most types of fuel can be used. For directly fired ovens only gas or light oil should be used to ensure the product is not affected by the fuel.

2.2 Bakery products

Large variations are seen across the world regarding types, recipes, and traditions for bakery products. Due to the short shelf-life of most bakery products, many have not spread across countries. Some products might only be known in particular regions. As a result there is no general, world-wide taxonomy for bakery products. Some product names even mean different things in countries otherwise having similar languages such as Great Britain and the USA. Two examples, biscuits and muffins, are illustrated by Figure 2.3.

In this work bakery products are divided into three main groups: cakes, bread, and biscuits. Cakes are sweet savory products, the batter is liquid, and the product baked in molds. During baking a soft crumb is obtained and a thin crust may be seen at the surface. Bread is a bakery product obtained from a semi-liquid dough, often with the addition of yeast to enhance bubble formation and volume expansion. During baking the



Figure 2.3: Biscuits: (a) The American breakfast course biscuit and gravy (All-recipes.com, 2012). (b) British biscuit products with tea (The Guardian, 2012). **Muffins:** (c) An American blueberry muffin (Starbucks, 2012). (d) An English muffin turkey sandwich (Orograin Bakeries Products, Inc., 2012).

dough is transformed into a soft crumb and a crisp to hard outer crust. Biscuit products cover a range of sweet to semi-sweet thin products. The dough is semi-liquid and the final product dry. The drying allows for a long shelf-life and a crisp, crunchy, or crumbly texture.

2.2.1 Investigated product groups

Two product groups were used for the research presented in this thesis, namely *bread* and *biscuit* (British translation). With the specific products investigated being a bread roll and a butter cookie. Short introductions to bread and biscuits are given in the following sections.

Bread

Bread is one of the most important staple food-products in the world today. The first bread was most likely produced on hot stones by the fire, creating a bread similar to the Middle Eastern flat bread of today (Cauvain and Young, 2007).

Archaeological findings indicate that the cultivation of pre-historic grain species began approximately 11000 years ago. The findings show that grain, or processed grain, was used as food products (Skaarup, 2011). Leavened bread is a much newer discovery. The oldest archaeological finding of leavened bread is approximately 5500 years old from Switzerland (Skaarup, 2011) and the oldest records of bread baking date back to ancient Egypt. Some of the oldest papyri appear to be bread recipes (Edwards, 2007). It was also in the ancient Egyptian society that bakeries were first organized and baking considered a specialized craft (Pomeranz and Shellenberger, 1971). In Figure 2.4 a painted panel from approximately 1200 BC shows bakers at the court of Ramses III.



Figure 2.4: Illustration describing an Egyptian bakery around 1200 BC (Pomeranz and Shellenberger, 1971).

Bread can be produced from few ingredients. The main ingredients are flour, water, and if a leavened bread is desired, yeast or sourdough. While the ingredients are very basic the same is not the case for the physical and chemical transformations during mixing, proving, and baking. A description of the transformation during baking is given in Chapter 3.

Biscuits

The word biscuit originates from the Latin words *panis biscoctus* meaning *twice baked* (Manley, 2011). The name is a reference to the original production method. The product was first baked in a hot oven, then moved to a lower temperature for a final drying step. In this way a dry product with a long shelf-life was produced. The process is still used today for some biscuits, for example the Italian *biscotti* is produced in a two-step baking process, maintaining the original meaning of the name.

The term biscuit is old and encountered in works such as the Shakespeare play “As you like” (circa 1600) and in Dr. Samuel Johnsons dictionary from 1755. In the latter it is defined as “a kind of hard dry bread, made to be carried to sea” (Manley, 2011). In the first biscuits, intended for sea travel (sea biscuits), the shelf-life was more important than the taste. It is not until later that biscuits have transformed into more common and savory food products.

Over the years biscuits have developed into a number of different products. Today the (British) meaning of the word biscuit includes such subgroups as crackers, cookies, sweet

biscuits, semi-sweet biscuits, and wafers. In contrast to bread these products are not staple foods. They are eaten mainly for pleasure, as a side dish, desserts or snacks. This meaning of biscuits is applied through this work.

2.3 State of the art

In this section the current state of the art for heat and mass transfer modeling and initiatives for experimental ovens is reviewed. The focus is primarily on work published in the last decade (approximately 2000 - 2013). A short description of the literature search criteria forming the base of the reviews is included in Appendix G. The modeling part of the review has been product specific, limiting the search to "bread, cookie, biscuit, cracker, and cake". Models considering these products are therefore the main focus in the review.

For modeling to make sense, experimental validation of the modeling work is of the utmost importance. The ability to verify and test the models in a controlled environment, monitoring the products, is crucial for the scientific and practical applications of developed models. This section is divided into two parts. The first concerning modeling work and different approaches to modeling of bakery products. The second section considering methods and equipment applied to experimentally validate mathematical models along with equipment build for pure experimental investigation of baking processes. The focus in the second section is on special experimental set-ups designed to improve the understanding of baking and baking process conditions. Experimental equipment designed for investigations of both laboratory and industrial scale is included.

Scientific articles explicitly aimed at describing experimental equipment for understanding or optimizing baking processes are scarce. The approach in the following section was therefore to include the methods described for baking experiments for model validation and not solely focus on work explicitly describing experimental set-ups. In most cases the ovens or baking processes applied for validation will include some degree of modification or redesign compared to commercially available equipment.

2.3.1 Heat and mass transfer modeling

Based on published work, modeling of bakery products may roughly be divided into two categories: The purpose of modeling is either to characterize and quantify the degree of browning during baking or to describe the mechanisms of heat and mass transfer processes during baking. The browning models are mainly focused on the kinetics of color development and often empirical in nature (Purlis, 2011; Zanoni et al., 1995), while the heat and mass transfer models are generally derived from mechanistic descriptions of the physical processes taking place during baking.

In the following the heat and mass transfer models are in focus, as this is the investigated aspect of baking in the present work. An important consideration for the heat and mass transfer modeling is, how many physical aspects to include when translating the physical understanding to applicable mathematical equations. From a mechanistic point of view an increasing knowledge of baking allows for more and more detailed models, while the challenge of determining the included parameters may be a limitation, when solving and validating the obtained models.

Different characteristics are relevant for modeling of different bakery product groups. The bakery products most widely used as model products for heat and mass modeling are bread, cakes and thin products like biscuits and cookies. While these products are distinctively different in nature the mathematical models describing the basic heat and mass transfer are generically similar. Also they are applied in modeling of other food products such as meat and vegetables (Chen, 1999; Ni and Datta, 1999; Sterner et al., 2002).

The most widely used description for mass (or water) transport is diffusion inside the product and evaporation on the surface. The energy transport is generally described by conduction inside the product and radiation, conduction, and convection to the product from the heating element. Of course exceptions are found; especially in porous products where evaporation is seen inside the product during baking. This results in additional heat transfer by Watt's principle of evaporation-condensation and mass transfer by a combination of liquid and gas. The following overview shows how different approaches have been applied for bakery products.

Heat transfer

Heat transfer is the primary transport phenomenon in baking processes. A hot oven chamber is used to transform the product from dough to the final product. Depending on the design of the oven chamber and the positioning of the product, different means of heat transfer will dominate the baking process. In traditional baking processes, these will be conduction, radiation, and convection.

Heat is transferred to the product where it travels through the surface, increasing the product temperature. Depending on the product characteristics, different approaches are applied when modeling the temperature increase through the product. For sufficiently thin products the temperature increase is assumed uniform through the product due to a very small temperature gradient. An example is modeling of a thin layer of cake (Putranto et al., 2011). In larger products, or products with a high resistance to heat transfer, a significant temperature gradient is created through the product. Of these two approaches the latter is most often applied for bakery products, increasing the complexity of the models.

Heat propagating through a solid body is generally described by conduction in heat trans-

fer models (Bird et al., 2002). In baking products an additional factor in the heat transfer process is the simultaneous evaporation of water. Water evaporation demands energy and thereby decreases the energy available for pure heat transfer. Different approaches are applied to include the water evaporation. Evaporation may be considered solely at the surface boundary, thereby limiting the energy transferred into the product and applied for heating (Ferrari et al., 2012; Feyissa, 2011; Mondal and Datta, 2010; Olszewski, 2006; Purlis, 2012). Other studies include the evaporation as a term in the equation describing the internal heat transfer (Huang et al., 2007; Ousegui et al., 2010; Sakin-Yilmazer et al., 2012; Thorvaldsson and Janestad, 1999; Zhang et al., 2005), and a third approach is to include evaporation both in the boundary conditions and as an internal phenomenon (Ploteau et al., 2012; Zhou, 2005).

In the first approach water evaporation is simplified so that it only takes place explicitly at the outer surface. The two other approaches emphasize the presence of an evaporation front moving through the product as it is heated. From a mechanistic point of view evaporation will take place both at the surface and inside the product during baking. The models with a moving evaporation front may, however, be difficult to assess. For the purpose of a given study a simplified model can provide an adequate simulation of the process. Which approach to select depends on the product and the over-all purpose of the study.

Models describing the heat transfer inside baking products may include additional physical details. For example the phenomenon of water evaporating in the warm end of an air cell (or bubble) and condensing on the inner and cooler wall, is included in some models (Hadiyanto et al., 2007; Thorvaldsson and Janestad, 1999). Compared to conduction this evaporation-condensation mechanisms will increase the heat transfer rate inside the product. With a continuous pore structure, connected to the outside environment, the influence of this mechanism will be small, as the evaporated water will diffuse away from the product.

Mass transfer

Transport of water through and away from the product is the main cause of mass transfer in baking processes. During baking the product is heated, resulting in a drying process as water evaporates. Additional mass transfer included in baking processes will often be diffusion of CO₂ either released from baking soda or produced by yeast.

Water transport is often described as a diffusion process. In some studies the water transport is separated into liquid water and water vapor transport described by separate equations (Feyissa, 2011; Hadiyanto et al., 2007; Huang et al., 2007; Lostie et al., 2004; Ploteau et al., 2012; Ousegui et al., 2010; Thorvaldsson and Janestad, 1999; Zhang et al., 2005; Zhou, 2005). Other models describe a combination of liquid and gaseous water transport in bread, with liquid water diffusion in the crumb and gaseous water diffusion in the crust (Purlis, 2012). An alternative approach is to consider all water transfer under

one, for example as the total mass loss or by an effective diffusion coefficient (Broyart and Trystram, 2002; Demirkol et al., 2006b; Ferrari et al., 2012; Mondal and Datta, 2010; Putranto et al., 2011; Sakin-Yilmazer et al., 2012; Wählby, 2002).

In most of the investigated models with more than one water transport mechanism the diffusion of CO₂ is also included along with the porosity of the product (Feyissa, 2011; Hadiyanto et al., 2007; Huang et al., 2007; Lostie et al., 2004; Ploteau et al., 2012; Ousegui et al., 2010; Zhang and Zhang, 2007). The porosity influences both the heat transfer and the mass transfer. The heat transfer through evaporation-condensation mechanisms, increasing the heat flux towards the product center. Gaseous mass transfer will increase through a continuous porous media while it may decrease the mobility for liquid water as the solid matrix is expanded.

Which model to apply will depend on the purpose of the study. When the moisture distribution through the product is of high interest a more precise model, including multiple mass transfer phenomena, would be a good choice. For a study of the drying mechanisms and the overall water content a more generic, or lumped, model is preferable. In both situations it is important to consider what parameters can be estimated with a sufficient accuracy, whether the model can be solved with available software, and if the model out-put can be validated through experimental work (Datta, 2008; Trystram, 2012).

Investigated products

The defining characteristics, such as appearance, texture, size, and moisture content, vary significantly between different groups of bakery products. The three main groups of bakery products covered by the investigated scientific studies are bread, soft cakes, and thin crisp products such as cookies and biscuits.

During baking, bread and soft cake products develop a dry crust and a soft, moist crumb. In the initial phase of baking the dough or batter can be seen as a semi-solid or liquid material with a number of small air bubbles. During baking the air bubbles will first expand, and when sufficiently heated, form a continuous porous network through the interior of the product (change from a foam to a sponge structure) (Mills et al., 2003). This transition is further elaborated in Chapter 3. At the surface, evaporation is initiated when the product reaches approximately 100°C, where after the water inside the product evaporates, causing expansion of the product along with an initial aided heat transfer towards the center of the product.

The development of biscuit products during baking is in some ways comparable to the development of bread and cake products. In the initial phase of the baking process a similar transition from a foam to a sponge structure is observed. However, contrary to the bread products the final part of biscuit baking is primarily a drying process (Mowbray, 1981). The sponge structure allows for evaporation from the entire product, resulting in a dry final product. The final moisture content in a bread crumb is approximately 40%

(w/w) while the final moisture content in biscuit products is as low as 0.5-3.5% (w/w).

The product group which is most widely used in the investigated models or review articles is bread (Hadiyanto et al., 2007; Huang et al., 2007; Mondal and Datta, 2010; Ploteau et al., 2012; Ousegui et al., 2010; Purlis, 2012, 2010; Therdthai, 2003; Thorvaldsson and Janestad, 1999; Wählby, 2002; Wählby et al., 2000; Zhang et al., 2005; Zhou, 2005). Most of the modeling studies investigating bread baking apply the more complex models treating liquid water and water vapor transport in different equations. For cake baking the applied models are more diverse. Some studies include porosity and multiple mass transfer mechanisms (Hadiyanto et al., 2007; Lostie et al., 2004), while others simplify the models to an average mass transfer consideration (Putranto et al., 2011; Sakin-Yilmazer et al., 2012; Sakin et al., 2007a,b). In all but one case, the models used to describe mass transfer in biscuit products include a lumped mass transfer approach (Broyart and Trystram, 2002; Demirkol et al., 2006b; Ferrari et al., 2012). In one case the same models are used for all three groups of product (biscuits, cakes, and bread) (Hadiyanto et al., 2007).

Considering the structure of the products, and their development during baking, the observed division in modeling approaches is reasonable. While it is interesting to model the thickness of the dry bread or cake crust, the over-all drying is more interesting for biscuit products. Additionally, bread and cake products are generally larger than biscuit products and more information of the internal mass transfer properties can be obtained and validated.

In the present work, studying a biscuit product, a lumped mass transfer approach is applied and validated against the total mass loss. Furthermore, a heat transfer approach with evaporation included only at the outer boundaries is implemented. The choice of heat transfer model is consistent with comparable studies of biscuit products (Demirkol et al., 2006b; Ferrari et al., 2012).

2.3.2 Laboratory and pilot scale ovens for research and model validation

In the following sections equipment and measuring methods applied to investigate baking processes, or validate mathematical models, in laboratory or pilot plant scale are described. Few articles are found, describing baking equipment as the main purpose of the study. Most of the methods and set-ups described in the following are indirectly described in the modeling work included in the previous sections.

Methods for model validation

Most ovens applied for validating the investigated mathematical heat and mass transfer models are standard household or laboratory ovens (Broyart and Trystram, 2003;

Demirkol et al., 2006a,b,c; Purlis, 2011, 2012; Purlis and Salvadori, 2007; Putranto et al., 2011; Sakin-Yilmazer et al., 2012; Sakin et al., 2007a,b; Thorvaldsson and Janestad, 1999; Zhang et al., 2005). The most frequently measured product properties are the product temperature (Broyart and Trystram, 2002, 2003; Demirkol et al., 2006a; Fahloul et al., 1994; Ferrari et al., 2012; Feyissa, 2011; Lostie et al., 2002b, 2004; Mondal and Datta, 2010; Ploteau et al., 2012; Purlis, 2012; Putranto et al., 2011; Sakin-Yilmazer et al., 2012; Sakin et al., 2007b,a; Thorvaldsson and Janestad, 1999; Wählby, 2002; Zhang et al., 2005) and the product mass loss or moisture content (Broyart and Trystram, 2002, 2003; Demirkol et al., 2006b,c; Fahloul et al., 1994; Ferrari et al., 2012; Feyissa, 2011; Lostie et al., 2002b, 2004; Mondal and Datta, 2010; Purlis, 2012; Putranto et al., 2011; Sakin-Yilmazer et al., 2012; Sakin et al., 2007a,b; Thorvaldsson and Janestad, 1999; Wählby, 2002; Zhang et al., 2005). The temperature is generally logged continuously during baking, while the mass loss is only measured continuously in one specially build experimental oven, which is also applied in investigated modeling work (Lostie et al., 2002a,b, 2004). In the main part of the studies the air temperature in the oven chamber is logged continuously.

Additional measurements include the air humidity (Broyart and Trystram, 2002, 2003; Fahloul et al., 1994), the product volume (Lostie et al., 2004; Purlis, 2010; Sakin et al., 2007a; Zhang et al., 2005), and product color (Broyart and Trystram, 2003; Purlis, 2010; Wählby, 2002). The air humidity is recorded continuously during baking by sensors placed inside the baking chamber. The product volume is either based on direct measurements on the product (Sakin et al., 2007a) or continuous video recordings, from which information on the product development is extracted (Lostie et al., 2004; Purlis, 2010; Zhang et al., 2005). Different methods were used to estimate the product color. In one series of studies the baking was interrupted, pictures taken of the products, where after the baking process was continued (method described in Purlis and Salvadori (2009)). In other studies the color or reflectance was measured on products removed from the oven during baking (Broyart and Trystram, 2003; Wählby, 2002).

Depending on the investigated models different measurements are relevant in the validation process. Most of the investigated studies apply the simplification that the volume expansion is neglected in the modeling work (e.g. (Ferrari et al., 2012; Mondal and Datta, 2010; Ousegui et al., 2010; Purlis, 2011)). In such cases it is evidently redundant to measure the product volume. From the high number of experimental set-ups measuring the product temperature, and either the moisture content or the mass loss, it is clear that the investigated studies were found because they focus on heat and mass transfer modeling.

For the validation experiments in standard household or laboratory batch ovens different types of externally connected thermocouple systems are used to measure the product and oven air temperatures. Some batch ovens are modified or constructed specially for research purposes, including sensors or special features for process investigation. In one case a standard household batch oven was modified to accommodate a specialized impingement heating process to investigate the effect of impingement baking versus traditional convection baking (Wählby, 2002). The focus of the study was on process control and the

influence of the air flow during baking. A special glass tube oven (Grenier et al., 2008) in which the air pressure is controllable and the product can be followed visually during baking. The oven applied in a modeling investigation of crust-less bread (Mondal and Datta, 2010) is also specifically constructed to the purpose. The oven has a water spraying device enabling a controlled water dosage during baking to inhibit crust formation. The oven is explicitly described in a newer article (Mondal and Datta, 2011).

A specially constructed radiation heated pilot oven is described by Lostie et al. (2002a). The oven has several options for monitoring the product continuously during baking. In the "modeling group" of investigated studies, it is the only equipment allowing continuous weight measurements. The oven is also capable of measuring the product temperature, the air temperature, and estimate the volume expansion through video recordings during baking. It is applied in at least two subsequent modeling studies (Lostie et al., 2002b, 2004). Compared to the process investigated in the present work, the oven described by Lostie et al. (2002a) is not constructed to emulate a continuous baking process. Additionally it is a radiation based oven, without the option for forced convection baking.

Some studies focus on continuous baking processes. Fahloul et al. (1994) apply a continuous pilot plant oven in the experimental work, and this data is also used in later modeling work presented by Broyart and Trystram (2002). The investigated biscuit product is baked in a 15m indirectly heated tunnel oven. During baking the product temperature is measured continuously, and the product weight is measured at six positions along the oven length by removal of products through hatches at the side of the oven. In McFarlane (2006) experimental work is carried out in two continuous tunnel ovens. The scope of the study is to investigate available methods to control the final moisture content in continuously baked products, the model product is a semi-sweet biscuit.

The main part of the investigated studies does not focus on continuous baking processes, but rather generic heat and mass transfer phenomena during baking. It is seen that variations in temperature, baking time, and in a few cases the humidity, have been most widely investigated.

The air flow has also been a source of process variation and the objective of modeling work. The group of modeling work studying air flow often apply computational fluid dynamics (CFD) to simulate the air flow and heat transfer in the oven chamber. For baking in continuous ovens this has been the main focus in articles published by Therdthai (2003, 2004a,b). The air flow around a heat flux sensor in a specialized pilot oven presented by Zareifard et al. (2006) was investigated in Boulet et al. (2010). CFD simulation is a valuable tool to extend modeling of baking products beyond the boundary of the product itself. Today the computational power to build 3D simulations of advanced flow patterns is becoming more readily available, which is likely to increase the number of studies, including the surroundings, when modeling baking processes. Similar to all other modeling work, the validation step is still important, and even advanced modeling should not stand alone.

Specialized pilot scale ovens for investigation of baking processes

Besides the ovens listed in the previous section, which are used in relation to experimental validation of mathematical heat and mass transfer models, additional pilot or laboratory baking equipment is described in the scientific literature. The research ovens are often build for a specific purpose, for which a standard baking oven is not suitable. Such ovens are described in the following.

A special "MRI-oven", described by Wagner et al. (2008), was constructed without any metal component, so that it can be placed in a low-field MRI scanner during bread baking. The experimental work was carried out by placing oil micro-capsules in the dough prior to baking and follow their movement during baking by the use of the MRI-images.

Another oven build to investigate a specific baking method is presented by Pace et al. (2011). This oven is constructed as a combined micro-wave/jet-impingement oven, with the purpose of investigating the effect of combining these two heating mechanisms on heating of a moist food product (potato in the described experimental work).

An oven specially developed to bake crust-less bread is described by Mondal and Datta (2011), and additionally applied in modeling work (Mondal and Datta, 2010). The oven consists of a baking oven chamber equipped with a water spray system allowing for wetting the product surface during baking, thereby preventing crust formation on the product surface.

The listed ovens are all constructed to investigate special baking methods or allow for a special product monitoring method. Other pilot scale ovens are constructed to investigate the general mechanisms and transformations taking place during baking.

One such oven is described by Fehaili et al. (2010). It is build with the purpose of having an oven chamber in which the thermal environment is fully characterized. The controlled environment is applied to characterize the kinetics of thermally induced reactions in a sponge cake. During baking the air and product temperatures are measured. The air and center temperatures, by separate thermocouples; and the product surface temperature, by an infrared thermometer equipped with a cooling jacket and placed into the oven chamber directly above the product. During baking the air is recirculated by an adjustable fan inside the oven chamber, resulting in a convective heating environment (its operation window given as 25 - 50 Hz).

Another oven constructed to monitor baking processes is a batch oven described in Sommier et al. (2005) and applied in at least two subsequent studies (Sommier et al., 2011, 2012). The oven described by Sommier et al. (2005) is a modified conventional, convection batch oven. Due to the modifications it enables extensive continuous monitoring of the process and product including temperatures, product weight, visual recoding of the product, and humidity measurements. In contrast to the oven presented in this thesis the oven described by Sommier et al. (2005) is not constructed with the initial scope to emulate continuous baking processes. In later studies the oven was used to study differ-

ences in pilot and industrial baking ovens (Sommier et al., 2011) and to characterize the convection baking of a sponge cake (Sommier et al., 2012).

In the investigated literature only one discontinuous pilot oven has been constructed with the purpose of emulating continuous baking processes (Zareifard et al., 2006). The oven described by Zareifard et al. (2006) is designed to reproduce industrial baking processes. The baking area in the pilot oven is 1.27 m x 1.17 m, resulting in a large baking area, and the need for a sliding table to load products into the baking chamber. This construction does not allow for a high degree of product monitoring during baking (temperature and humidity control) and the options to vary the baking process are limited. From the description of the convective system it appears that the air is externally heated and the air flow parallel to the baking tray. The ability of the oven to heat evenly is validated with a special heat flux measuring system and by browning of a light cake during baking. The heat flux measuring system is applied to compared the total heat flux across the baking tray and between different baking settings. In subsequent studies the heat flux measuring system is used to compare the effect of radiation and convection when maintaining a constant total heat flux (Zareifard et al., 2009), and CFD simulations of the air flow are investigated in relation to temperature distribution in the oven chamber (Boulet et al., 2010).

2.3.3 State of the art summary

The review of modeling contributions from recent years shows that advanced models have been developed. The degree of complexity was generally found to be higher for bread and cake products than for biscuit products. While similar heat and mass transfer phenomena are seen in the different products, the effect of processes such as CO₂ expansion, bubble formation, and to some degree porosity are more pronounced for bread and cake products. These products consist of a soft, airy crumb and a dry outer crust. In the initial phase of biscuit baking the products undergo a transition similar to the soft bakery products, however, the final phase of biscuit baking is a drying of the entire product. The final drying is characteristic for the biscuit group and the final uniformity of the product is probably the reason for the successful use of lumped mass transfer descriptions in the mathematical models.

Similar to most modeling studies of biscuit baking the model formulated in Chapter 7 is based on a lumped approach to describe the mass transfer. The scope of the present work has been to establish a mathematical model of the biscuit baking process in the pilot oven.

In addition to the investigated studies of biscuit product modeling (Broyart and Trystram, 2002; Demirkol et al., 2006b; Ferrari et al., 2012; Hadiyanto et al., 2007), elements from a model of meat patty frying are also used for my modeling work (Chen, 1999). The meat patty has a similar geometry to the investigated biscuit product. It is also cooked in a convection oven resulting in a similar modeling set-up with comparable boundary

conditions.

The focus in the present work has been on the boundary conditions related to mass transfer. No published work was found to explicitly discuss the influence of covered surfaces on the mass transfer during baking of biscuit products.

In some studies a model with equal boundary conditions on all outer surfaces is used, neglecting any possible effect of a mold or baking tray. In this way equal evaporation is obtained in all directions away from the product center (Ferrari et al., 2012; Purlis, 2012). In the modeling results obtained by Ferrari et al. (2012) a poor correlation is seen between the measured mass loss and the simulation. The product was placed in a perforated mold during baking, and by assuming uniform evaporation the effect of the mold appears to be underestimated. The assumption of asymmetric evaporation is also found, for example for products such as biscuits, cakes, and pancakes. In these studies water removal is only included from the free surfaces, assuming no evaporation takes place from the covered surfaces to the surroundings (Demirkol et al., 2006b; Feyissa, 2011; Olszewski, 2006; Sakin et al., 2007a). Sakin-Yilmazer et al. (2012) model the heat and mass transfer in ring cake baking. They included the effect of the mold covering the side and bottom surfaces of the product by lowering the mass transfer at these surfaces compared to the free surfaces. Although a discussion or evaluation of the chosen mass transfer coefficients was not included, the study was inspiring for the modeling work presented in the last part of the present thesis. Here the effect of the baking tray on the evaporation in butter cookies is investigated by varying the boundary conditions.

The reviewed studies show that baking equipment for experimental work and model validation has not been a thoroughly investigated area within baking technology research. Most modeling oriented studies appear to use standard kitchen scale ovens, which are not specially designed for model validation. The applied oven conditions are included in the models through the boundary conditions, for example by including several parallel heat transfer mechanisms. The best attempts to quantify differences between baking processes were found to be measurements and comparisons of total heat flux in pilot and continuous ovens (Sommier et al., 2011; Zareifard et al., 2009).

Ovens build to investigate specific aspects of baking or specialized baking processes are described in the literature. Additionally, a few ovens allowing for controlled process variations were found. Through the literature search it has not been possible to identify other pilot scale ovens, constructed to emulate a continuous baking process and continuously monitor the product visually and by weight during baking. One unique feature of the oven presented in this thesis, is its ability to emulate the air flow pattern found in the investigated type of convection tunnel ovens.

Besides emulating the air flow found in convective tunnel ovens, a vital objective for the collaboration with Haas-Meincke A/S was to construct a pilot oven working outside the normal operation range of tunnel ovens. A feature which has not been described in any of the reviewed articles. The ability to vary process conditions, such as the humidity, tem-

perature, and air velocity, is an interesting area of research, and requested by researchers and oven manufacturers:

"An interesting alternative to bread manufacturers would be specialized ovens that allow adjusting the heat transfer coefficient. Therefore, in addition to the improved efficiency sought by oven builders, versatility in terms of design, optimization, and control of the baking process would be delivered to baking industry." - Purlis (2012)

In the new pilot oven this is one of the wishes that has been fulfilled. Adjusting the inlet air velocity will create variations in the over-all heat transfer coefficient. Additionally, it is possible to change the distribution of air entering the oven chamber above or below the product, along with the distance between the baking tray and the inlet nozzles.

The ability to vary inlet air velocity and the distance from inlet nozzles to the baking products is not available in the industrial tunnel ovens of interest. These features enable experimental work, and model validation, outside normal operation range in the industry.

It is clear from the present review that improvements are still needed in mathematical descriptions of heat and mass transfer in bakery products. The present thesis contributes to advancement in this field. The main contributions are the construction of the pilot oven, enabling complex validation and experimental conditions, and the modeling work, investigating the effect of the baking tray on the mass transfer properties in a biscuit product.

2.4 Project hypotheses

The research question establishing the foundation of the present work is:

How do process conditions influence characteristics of products during baking in a continuous, convection tunnel oven?

In the project this question is investigated through a number of specific objectives covering experimental and theoretical work. A goal of the present work is to obtain increased understanding of the influence of baking conditions on the product quality through pilot plant experimental work and mathematical modeling. Experimental work in full-scale continuous ovens is resource demanding, and the options for monitoring the product and modifying the process conditions are very limited. Therefore the following hypothesis has been the basis for the presented work:

It is possible to construct a pilot batch oven capable of emulating continuous baking processes as seen in a common type of industrial oven. This pilot oven will allow for controlled and monitored experimental work, enabling increased knowledge and understanding of industrial baking processes, that can be applied for the improvement of mathematical modeling of the investigated processes.

The hypothesis is evaluated through a number of specific objectives. Working with these objectives the goal was to either verify or reject the hypothesis. The objectives are listed below and they are considered the aims of this project:

1. To design and construct a pilot batch oven which can emulate the process conditions in convection tunnel ovens as designed by Haas-Meincke A/S.
2. To validate the pilot oven. The validation is separated into two steps, first: ensuring even heating in the baking area and second: examining the oven's ability to emulate a continuous tunnel oven.
3. To describe the baking process through a mathematical model that can be solved numerically.
4. To apply experimental data from the pilot oven to improve the mathematical model and show that the combination of experimental data and modeling can increase knowledge and understanding of the investigated baking process.

Due to the delay in the pilot oven production an additional objective was added to the list:

5. To review the methods applied for objective quality assessment of bakery products, and examine the prospects of a new method for bakery product evaluation.

Chapter 3

Mechanistic description of baking processes

In this chapter the changes, which a product undergoes during baking, are described. The overall transformations in the dough are described along with the main physical changes. For a thorough chemical description of baking and the associated reactions, such as Maillard reactions and starch gelatinization, the author refers to other more comprehensive works such as (Davidek and Davidek, 2004).

The chapter covers baking of two quite different types of bakery products, bread and biscuits. Bread is a moist and spongy product with a final crumb moisture content around 40%. Biscuit are dry and crumbly products with a final moisture content below 5%. The baking process is described stepwise for each of the two product groups. Although the main focus in the project has been on biscuit baking, the mechanisms in bread baking are included for comparison and to give a thorough introduction to the mechanisms in baking products.

3.1 Ingredients and dough preparation

The first step when baking is to select the right ingredients, in the right quality. In this section the most common ingredients in bread and biscuits are given.

The most basic ingredients in all bread products are flour and water. Where the water is working as a binding agent to help disperse soluble ingredients throughout the dough. In bread products the water content in the dough is high, around 40% (w/w) in the recipe used by this author (cf. the work presented in Appendix B). The water content in biscuit dough is much lower, 15% (w/w) in the recipe used in this work, and generally considered to be between 10-40% (w/w) (Mowbray, 1981).

For both bread and biscuit baking the protein content of flour is very important. A high total protein content is often equivalent to a high concentration of the protein gluten.

When kneaded, gluten forms a strong network which results in the spongy structure of bread crumb. Therefore a high protein content is desirable for bread baking. The protein content for bread flour is generally between 12-13% (w/w) (Cauvain and Young, 2006). In biscuits on the other hand a low gluten content is desirable to maintain a crumble texture in the products, the protein for such products should be 9-11% (w/w) (Manley, 2011; Cauvain and Young, 2006).

The type of biscuit studied in this work falls in the biscuit category of short-dough biscuits (Manley, 2011). For these biscuits two additional ingredients are especially important for the sensory (taste and texture) experience: Sugar and fat.

Fat (or shortening) stabilize bubble formation in the dough, and prevents gluten networks from forming (Cauvain and Young, 2006; Manley, 1998a).

Sugar does not only contribute to the biscuit with a sweet taste. It is also important for the structure of the biscuit, and the surface browning reactions. The surface browning is for a large part due to caramelization and Maillard reactions between reducing sugars, e.g. glucose, galactose, and maltose, and amino acids (Davidek and Davidek, 2004; Broyart et al., 1998; Capuano et al., 2008). Main sources of amino acids for Maillard reactions are ingredients such as milk, milk powder, or eggs.

In most products some degree of rise or formation of air bubbles is desired. Leavening agents are either chemical, e.g. bicarbonate of soda, or biological, such as yeast or sour-dough. While exceptions are seen, most biscuits are leavened by chemical agents and most bread products by yeast or sour-dough.

Additional ingredients are often included in bakery products, either for the texture, taste or appearance including eggs, salt, savory ingredients (chocolate chips, nuts, dried fruits), and enhancing ingredients (enzymes, ascorbic acid, emulsifiers) (Cauvain and Young, 2006).

The ingredients are mixed according to a given recipe. Then biologically leavened products are left to rise for a certain amount of time. The chemically leavened dough might be left for a short pause to allow the ingredients to set, and flavors to fully dissolve in the dough matrix.

After rest or rise the products are shaped. A number of different methods exist to shape biscuits, such as wire cutting, sheeting, extrusion or molding, all giving different properties and shape characteristics to the final product. Bread is shaped by different rolling and shaking mechanisms. After shaping biologically leavened products are proved at increased air humidity and temperature. Finally the products are placed in or transported through the oven chamber.

The oven type will vary in type, depending on the desired final product. For bread products radiation or directly fired ovens are often used (Pedersen, 2009). Biscuit products are mainly baked in convection or directly fired ovens (Pedersen, 2009), depending on the specific biscuit product.

3.2 The baking process

Overall baking processes can be separated into two main phases: a heating phase and a drying phase. During the initial heating phase the product temperature is elevated to a point where water begins to evaporate from the surface. When this temperature is reached the main portion of the transferred energy will be used to evaporate water, and only a small part will be used to heat the bulk product. The processes taking place in bread products and biscuits are slightly different and the baking process in the two groups are therefore treated in two different sections.

3.2.1 Bread baking

The bread baking process is illustrated schematically in Figure 3.1. In the figure the process is divided into five steps, whereof the first four are the actual baking.

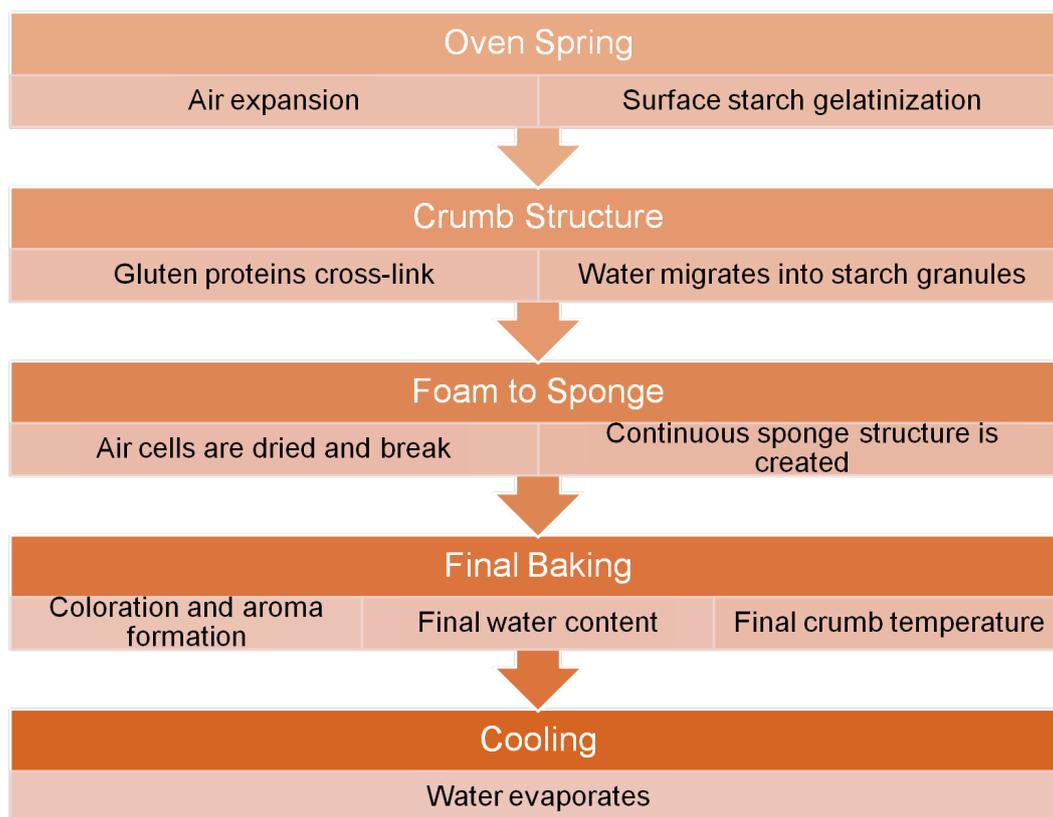

Figure 3.1: Overview of the steps in the bread baking process.

Oven spring: When the cold dough is placed in or enters the oven chamber, energy is transferred to the surfaces of the bread. Energy transfer takes place by radiation from the oven chamber walls and the baking band, conduction through the baking band, and convection from air movement. Additionally water vapor may be used in bread baking to

increase the initial heat transfer rate and create a shiny crust. Water vapor will condense on the cold surface of the product increasing the heat transfer process.

From the product surface, energy will move inwards towards the colder center. This will happen both by conduction along the solid dough matrix and by water evaporation/condensation in the small air pockets formed by kneading and fermentation (McGee, 2004).

The air entrapped in the dough, in small air cells, will start to expand as they are heated. When heated, the dough becomes softer allowing the air expansion to increase the product volume. This process is called the oven spring with the total oven spring being the difference in height between the unbaked and the final product (Cauvain and Young, 2006). The limiting factor for the oven spring is solidification of the bread surface, or crust formation (McGee, 2004). The crust is formed when water evaporates from the surface leaving the outer layer of the product dry and inflexible.

Crumb structure (foam to sponge): Water will primarily evaporate from the surface, leaving the internal water concentration constant throughout baking. Measurements made by the author showed that the water content in dough is the same as the water content in the final bread crumb (g_{water}/g_{sample}), in the investigated case approximately 40%.

During baking the bread crumb still undergoes a transformation. In the beginning of baking the dough contains a number of separate cells, which can be compared to a foam structure. The starch molecules gelatinize as they absorb water and the proteins denature due to the heat (McGee, 2004). These transitions will create an increasingly inflexible structures around the cells. In the cells water vapor and air will expand as the product is heated. As the cell walls becomes rigid they will start to break. In this way a continuous network is formed through the product, transforming the crumb from a foam to a sponge like structure (Mills et al., 2003).

The foam to sponge process is illustrated schematically in Figure 3.2(a) and on the pictures in Figure 3.2(b). The pictures are taken by the author showing bread rolls which were steam-baked at 95°C. The low temperature with additional steam injection was chosen to assure no crust formation as only the crumb development was of interest and the bread rolls should be easy to cut.

Final baking: The crust is formed at the surface as moisture evaporates. One of the appealing features of bread crust is the brown color and aroma components formed by sugar caramelization and the Maillard reactions. These reactions require a high temperature and intermediate to low water activity (Capuano et al., 2008; Purlis, 2010). Investigation of the browning reactions in crackers showed that browning was initiated in the temperature interval of 105-115°C (Broyart et al., 1998).

If steam is added in the initial phase of baking, resulting in water condensation on the

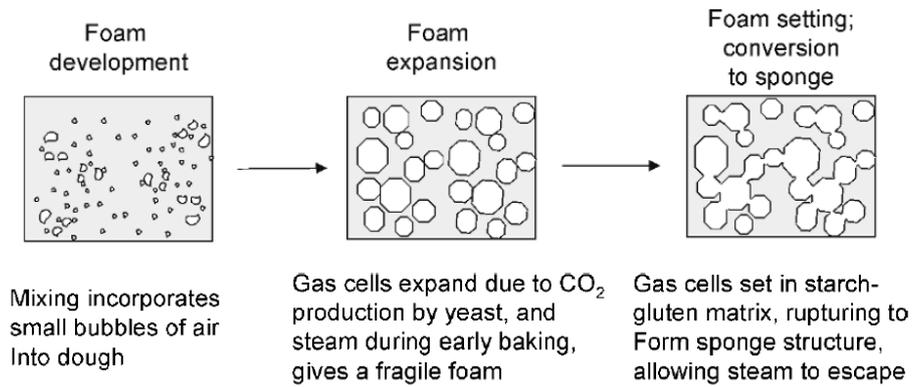

(a) Transition from foam to sponge in bread dough, schematically (Mills et al., 2003).



(b) Picture of bread rolls steam-baked for different periods of time. Photo: by author, January 2010.

Figure 3.2: Illustrations of the crumb transition from foam to sponge during bread baking.

surface, a shiny crust can be obtained. This happens because the water helps gelatinize the starch forming a glossy surface. The difference between steam and no-steam can be seen in Figure 3.3.



Figure 3.3: Crust difference on bread rolls baked with steam (left) and in dry air (right). Photo: by author, March 2010.

3.2.2 Biscuit baking

Biscuit baking can be divided into two stages (Mowbray, 1981). First the development stage, similar to the oven spring for bread, then the drying and coloration stage. An overview of the physico-chemical processes taking place in each step is shown in Figure 3.4.

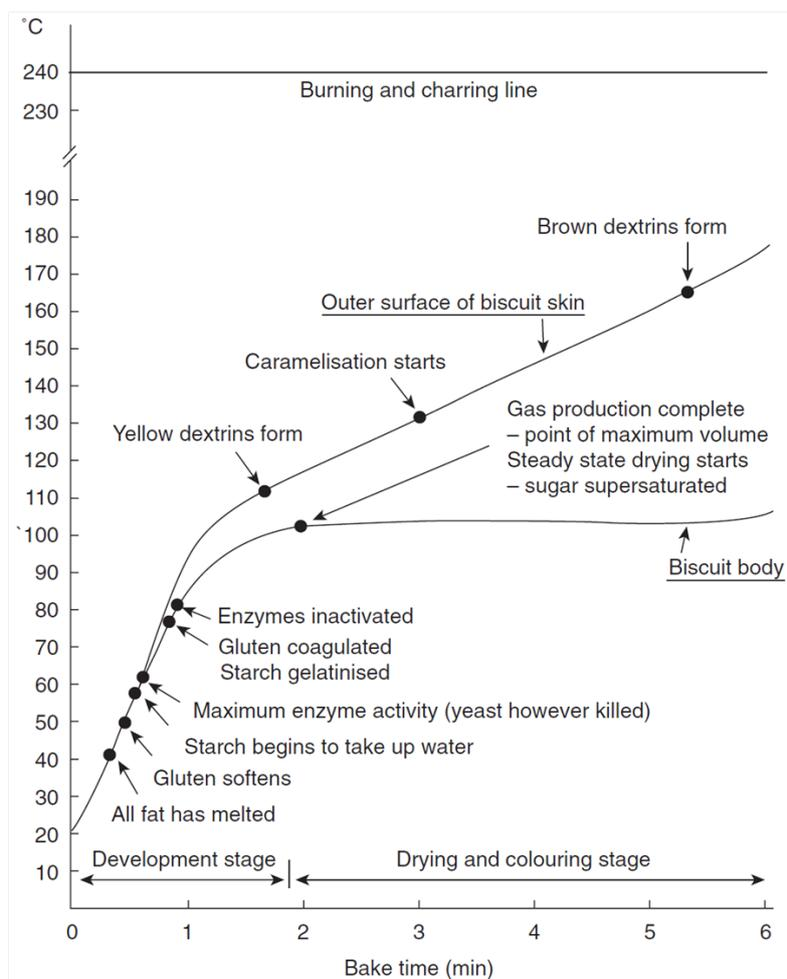

Figure 3.4: Schematic illustration of the steps in biscuit baking. The two lines representing the biscuit surface and interior body, respectively. Illustration adapted from (Mowbray, 1981).

Development stage: In the first stage the same processes as in bread take place throughout the biscuit. When observing biscuits with a high fat content, such as butter cookies, this first phase is seen as a whitening of the surface. The appearance of the biscuit becomes softer and the edges rounder. A certain oven spring occurs as CO_2 is formed by the chemical leavening agent and water vapor expands in the soft dough. This expansion results in a foam to sponge process as seen in bread products. As the dough transforms from foam to sponge it allows for water vapor to move through the now porous product (Manley, 2011). The transport of vapor is faster than that of liquid water transported by

diffusion in the solid biscuit matrix.

Drying and coloring stage: When the surface temperature exceeds 100°C the water begins to evaporate. The water evaporation dries the surface and browning from the Maillard reactions and caramelization of sugar is initiated.

The drying step is the longest of the two phases. Opposite bread products, the whole biscuit is dried to obtain a long shelf-life and the desired texture. For the butter cookies investigated in Chapter 8 the water content decreases from approximately 15% to 0.5-3.5% depending on the baking time. A stagnation in biscuit body temperature is seen when evaporation is initiated. In the beginning of the evaporation step the moisture will be freely available for evaporation slowing down the heating of the biscuit body. As the freely available water is evaporated, the temperature of the biscuit dry matter will increase. The more tightly bound water is now evaporated by slow diffusion drying.

Most biscuits are still soft when removed from the oven. The full setting of the biscuit structure does not occur until the biscuit is sufficiently cooled. During baking the sugar in the biscuit has formed a syrup. When cooled the sugar in the syrup will transform to a glass state. The glass transition process, possibly combined with hydrogen bonds formed between proteins and starch molecules, result in the final crisp and brittle texture of biscuits (Chevallier, 2002; Pareyt and Delcour, 2008).

During storage the texture of the biscuit changes as the dry product starts to absorb moisture from the air. Moisture absorbed from the air will change the structure in the biscuit from glassy to rubbery as moisture causes the sugar's glass transition temperature to drop below room temperature (Martinez-Navarrete et al., 2004). To protect the products and obtain the longest possible shelf-life with a good sensory quality biscuits are often packaged air tight using materials with controlled water permeability (such as coated cellophane films, polypropylene films, films coated with aluminum foil or metallized films) (Manley, 1998b).

3.3 Complexity and modeling

This chapter has given an overview of the major changes happening in two types of bakery products during baking, with focus on the physical-structural changes. A full description of a baking process, including all changes and parameter interactions would comprise a very large and complex work in its own right. The final goal in this work is a quantitative model, suitable for simulations of varying process parameters in baking processes. The complex baking process must thus be appropriately simplified while still maintaining a sufficient degree of accuracy.

The main processes included in the simulation are the heat and mass transfer. These two processes are not necessarily complicated to model, depending on the assumptions.

If the product is assumed to have a uniform temperature and constant physico-chemical properties throughout the process, the heat and mass transfer modeling can be calculated easily. However, in the case of biscuit baking this would lead to a poor model, unable to give a representative approximation to the real process.

A full model including all factors and purely based on the physics of the process would be considered a white box model. This type of models are not only heavy in regard to calculations they might also be difficult to obtain as all the needed information may not be readily available. The opposite approach to model building is to base the description purely on experimental data. This approach is called black box or empirical modeling.

Between these two approaches there is a gray area of white box models supplemented by empirically obtained descriptions (Hadiyanto et al., 2007). In this work the “gray box” approach will be used for the mathematical descriptions of the baking process in Chapters 7 - 9.

Chapter 4

Quality assessment methods for bakery products

This chapter is concerned with a study of typical methods for objective evaluation of bakery product quality. The focus of the study is mainly on methods applied in academic work. Therefore the study, its results, and conclusions are based on findings in the academic literature.

The main target of the work described in this chapter is to create an overview of the most widely applied methods. Additionally the methods tested and applied in the present work are considered in relation to the experimental work.

4.1 Objective quality assessment

When looking at a product we instantly have a feeling of whether we will like the product or not, but how do we know this? And more importantly for the manufacturer of the product, how can this knowledge be quantified?

Often people talk about “quality”, saying that a certain product is either good or bad quality. We may have the feeling that we know what they mean, and either agree or disagree. However, this kind of undefined quality is highly subjective and two different people may feel completely opposite when talking about likes and dislikes based on their personal preferences and their history with a given product. The science of turning subjective preferences or evaluations of food products into a quantifiable measure is sensory analysis, and is a whole field of study in itself.

For industrial day-to-day production it is important to have processes with a high degree of consistency and predictability. The properties of the product should not change from day to day or batch to batch. A relevant quality parameter in this case will show the reproducibility of the product. This is also the case if a product is produced around the world. Then reproducibility as a quality parameter will demand that it is possible

to produce the same product at different sites independently of local variations in raw materials, climate, personnel, or equipment.

In the following, objective and quantitative quality assessment methods used to evaluate bakery products are investigated. A full investigation of quality assessment methods for all bakery products is out of the scope for this project. The specific product group investigated is therefore limited to biscuits (as defined in Section 2.2.1). The main focus is on methods applied in published scientific work to quantify the quality of different biscuit products. Sensory analysis is not included in the following study. These methods require time and specially trained personnel to give objective quality assessment results.

Quality assessment methods are in the following divided into four different categories to simplify the overview and descriptions. The following categories have been used to group the investigated research: Product appearance, physical dimensions, texture measurements, and evaluation of the product composition.

4.1.1 Quality assessment methods in academic literature

To create an overview of the most commonly used assessment methods a targeted literature review was performed. The literature was found in the article database of the Technical Information Center of Denmark. The search resulted in 634¹ hits for journal articles. Covering articles (in some cases only titles and abstracts) from 1910 to the spring of 2012. Not all were relevant or describing quality assessment of baked biscuit products. For the present study 42 full-text articles were selected going back to 1936 and mainly covering the recent years of research. The distribution over year of publishing, along with an overview of the categories of assessment methods used in each article, are found in Appendix H.

The overall distribution between the chosen quality assessment categories is shown in Table 4.1. Based on this distribution the most widely applied group is evaluation of one or more physical dimension (height, width, length and/or diameter). In this group the spread ratio (diameter or length divided by height) is often used. The appearance, mainly the surface color measured as CIE L*a*b*-values, was the second most applied method. For texture measurements mainly the hardness (the peak force at a break) was measured.

In several of the investigated studies more than one method was used to evaluate the products. For example all groups are applied in (Mamat et al., 2010); measuring the width, length, thickness, and volume (dimensions), the hardness (texture), the color (appearance), and the water content (composition).

Interestingly few authors explain their choice of quality evaluation methods. One of the few examples is by Perrot et al. (Perrot et al., 1996). A short explanation is given that the surface color is measured as the “*operators have an important task in the evaluation of*

¹June 5th, 2012

Table 4.1: Overview of the division between the quality groups in the 42 investigated articles, more than one group may be used in the same study.

Appearance	16
Dimensions	34
Texture	16
Chemical/composition (incl. moisture and a_w)	15

product qualities, specifically color” (Perrot et al., 1996). The goal of that specific project was to substitute the operator by an automated assessment method.

In the majority of studies the assessment method is simply stated with no further explanation. It is thus up to the reader to deduce whether the applied method would mainly benefit research interests, process development, the consumer, or the manufacturer.

The following sections contain a short overview of the most widely used methods within each assessment category. These are followed by a short discussion of the methods applied in the present project, focusing on the butter cookies investigated in relation to validation of the batch oven and the following modeling work.

4.1.2 Evaluation of physical dimensions

In more than 80% of the investigated studies the dimensions of the product were included to describe the quality of the product. In 31 studies the width (diameter or length) of the product was given as a quality property. The diameter or width divided by the height of the biscuit (called the spread or spread ratio), was additionally calculated in 11 cases.

A probable reason for many researchers to apply geometrically based assessment methods are standards for flour quality assessment published by the AACC (AACC, 2012; Bettge and Kweon, 2009). In these standardized methods the width, height, and spread ratio are used. According to the description of these methods there is a relation between the quality and the cookie geometry. A high quality flour will result in a larger diameter and lower thickness than a poor flour quality.

In the investigated articles the spread ration with reference to AACC methods was primarily used to evaluate differences in baking quality when varying the product recipe (e.g. sugar types and amounts (Bettge and Kweon, 2009; Nishio et al., 2009), addition of cumin and ginger powders (Abdel-Samie et al., 2010), and flour composition and fiber content (Özboy Özbas et al., 2010)).

Other properties included in the physical dimension category were: volume, weight, porosity, and absorption. Of which the last two were only seen in one study (Latimer and Watts, 1936) from 1936.

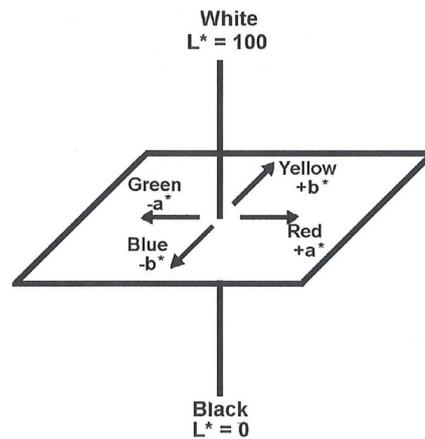

Figure 4.1: The CIE $L^*a^*b^*$ coordinate system (HunerLab, 2012).

4.1.3 Evaluation of appearance

The most widely used assessment method for appearance is the surface color measured in $L^*a^*b^*$ -coordinates with colorimeters, for example Minolta Chroma Meters. The Commission Internationale d'Eclairage (CIE) developed the internationally applied $L^*a^*b^*$ -system for color measurements in 1976 (Yam and Papadakis, 2004; Dansk Standard, 2011). The CIE $L^*a^*b^*$ -values give a 3D representation of the color of an object based the three aspects.

The L^* -values represent lightness in the interval 0 - 100, from absence of light (black) at 0 to complete lightness (white) at 100. The a^* -value indicates the position between red and green and the b^* -value the position between blue and yellow. The a^* - and b^* -values are prefixed \pm depending on the dominating quality of the color. The coordinate system is illustrated in Figure 4.1. Amongst the investigated articles 12 applied assessments of $L^*a^*b^*$ -measurements (Broyart et al., 1998; Purlis, 2010; Mamat et al., 2010; Perrot et al., 1996; Abdel-Samie et al., 2010; Özboy Özbas et al., 2010; Manohar et al., 1999; Ozturk et al., 2009; Seker et al., 2009; Stevenson et al., 2010; Goldstein and Seetharaman, 2011; Romani et al., 2012). In the studies measuring $L^*a^*b^*$ -values the L^* -value is often correlated with browning. The lower the L^* -value the darker the surface, and thus the higher the degree of browning on the bakery product surface (Purlis, 2010).

Other appearance evaluation methods include whiteness (Manohar et al., 1999) or digital capture methods such as photography or image analysis (Stevenson et al., 2010; HadiNezhad and Butler, 2009a). The photographic method applied in one study was used to evaluate the dimensions of the biscuits during baking (Bettge and Kweon, 2009), comparing different cutting methods. In another study a camera was used to evaluate the visual coarseness of the product surface (HadiNezhad and Butler, 2009a). None of the investigated articles were concerned with methods such as near infra-red spectrometry or more advanced imaging systems.

4.1.4 Texture evaluation

The experience when biting a biscuit is of great importance for the consumer's experience of biscuit quality. A soft, chewy, or spongy feeling is rarely an indicator of good biscuit quality. Crisp, crumbly, or brittle are more desirable descriptors of the biscuit texture. Descriptors such as these are used in sensory analyzes of biscuits. In such analyzes trained panels of judges evaluate the products and assign them with specific characteristics. However, sensory evaluations are laborious and need more preparation than what is generally desirable for fast quality evaluations, especially in a production situation.

Alternatively objective texture measuring methods may be used. 16 of the investigated studies included some form of texture analysis. 15 of these reported a breaking or penetration force (Mamat et al., 2010; Abdel-Samie et al., 2010; Özboy Özbas et al., 2010; Latimer and Watts, 1936; Manohar et al., 1999; Seker et al., 2009; HadiNezhad and Butler, 2009a,b; Jacob and Leelavathi, 2007; Kweon et al., 2011; Maache-Rezzoug et al., 1998; Pareyt et al., 2010; Saha et al., 2011; Sindhuja et al., 2005; Zoulias et al., 2000), and one the product brittleness (Grizotto et al., 2010). One study supplemented the breaking force measurement with the breaking distance, indicating the elasticity of the product (Zoulias et al., 2000).

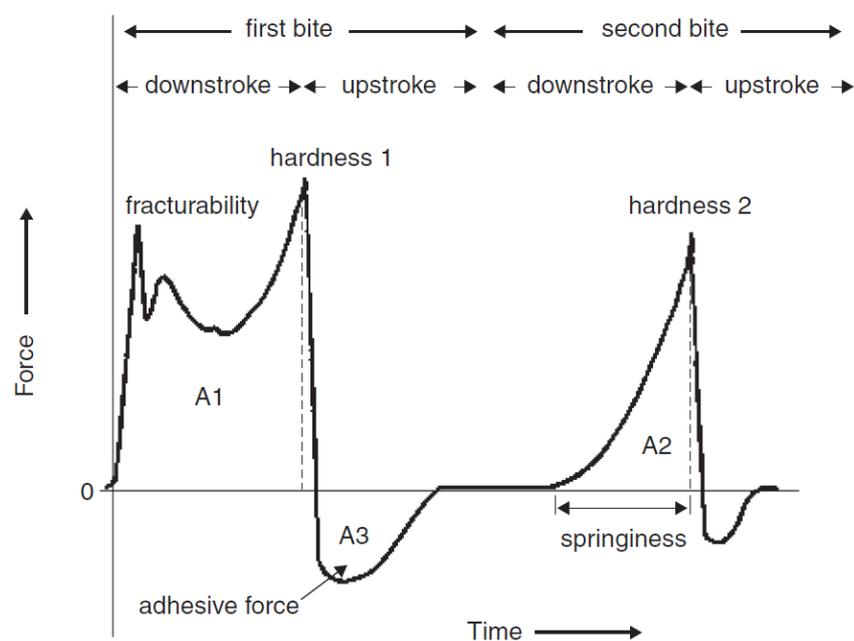

Figure 4.2: Force as a function of time for a double compression texture analysis profile (Mochizuki, 2001).

Most texture assessment methods are based on force measurement when a probe compress or penetrate the investigated sample. The measurements are carried out in specialized machines, texture analyzers. Different probes and rigs exist for measurements of different properties of different food products. From the measurements the result is given as a graph showing the force as a function of either time or length. From the obtained data a

number of characteristic properties for the product are found, such as the maximum force (hardness), the first break in the product (fracturability), and the work needed for the compression by integration of the positive area under the graph when the force is a function of distance (Mochizuki, 2001; Bourne, 2004). An example of a double compression, texture profile analysis or TPA, mimicking the first two bites into a food product is shown in Figure 4.2.

4.1.5 Product composition

The main aspect of product composition investigated in the examined articles was the content or availability of water. The water content or water activity was used as a measure for the product quality in 12 of the 15 articles in this category (Broyart et al., 1998; Mamat et al., 2010; Goldstein and Seetharaman, 2011; Romani et al., 2012; Kweon et al., 2011; Pareyt et al., 2010; Zoulias et al., 2000; Grizotto et al., 2010; Akingbala et al., 2011; Arogba, 2002; Hong et al., 1996; Wade, 1987).

The water content and activity are relevant parameters regarding the shelf life and eating experience of crisp products such as biscuits. When measuring the water content directly it is also a way of evaluating the degree of drying and thus mass transfer that has taken place during baking.

In relation to research and understanding of the mechanisms of baking the water content is an important aspect. The same is the case in quality assurance and when implementing changes in the production process. For the average consumer on the other hand, the water content as a quality assessment aspect is a more hidden characteristic of the product.

Besides the water content other investigated aspects of the product composition were more related to health issues. These included content such as following: fiber content (Seker et al., 2009; Akingbala et al., 2011), the protein content (Pareyt et al., 2010), and the presence of allergens (Monaci et al., 2011).

4.2 Choosing assessment methods for the present work

When choosing an assessment method it is important that it renders the desired information. Thus the underlying reason for wanting to perform quality measurements must be clear. For example when investigating changes in the process conditions, it is beneficial to consider the following questions:

- Which aspects of the product could be influenced by the change?
- Which of these aspects are crucial for the rest of the production, or in themselves vital product characteristics?

When this is clarified a suitable assessment method may be selected.

In the present work, the focus is on predicting the effect of the baking oven conditions, on the quality, or properties, of the bakery product. In the modeling work the heat and mass transfer during baking is examined. The assessment method applied for model validation must therefore reflect the investigated aspects. Therefore measurements reflecting the heat and mass transfer are applied.

The results obtained from the mathematical models are the water concentration and the temperature in the product. The water concentration is evaluated as the weight loss during baking. This is based on the assumption that all mass loss during baking is due to water evaporation. The temperature is measured inside the product. The temperature is not a typical quality assessment parameter. However, as it is applied for the purpose of model validation it is included in this section.

Additional studies of the influence of different baking times, temperatures, and air velocities were conducted (Section 4.3 and Chapter 6). For these studies additional assessment methods were considered compared to the model validation. In the experimental work the applied quality indicators should preferably show a change if the process conditions were changed. This was desirable when validating the batch oven against the tunnel oven.

Physical dimension measurements were tested. The diameter was measured, however no correlation was found to the applied process variations. The spread was not investigated in this work. Generally the spread has mostly been associated to changes in the product composition, therefore its dependency on process variations could be interesting to study.

Initial experiments using texture analysis were carried out using a TA.XT2 Texture Analyzer (Texture Technologies Corp. and by Stable Micro Systems (Texture Technologies, 2012)). An example of the breaking force for a three-by-three experiment, varying the baking time and oven temperature, analyzed by a three point bend rig (Martinez-Navarrete et al., 2004) is shown in Figure 4.3. An example of a three point bend rig (the shown cookie is smaller than those for model validation) is shown in Figure 4.4.

The reproducibility of the texture measurements was low and no differences were seen for the investigated oven settings. Therefore this method was not used to evaluate the butter cookie quality.

In the following studies mass loss measurements are supplemented by assessments from the group of appearance evaluation methods. A total of four methods were applied in the studies; one of which has been categorized as a sensory method.

In Section 4.3 a study examining an image analysis method for quality evaluation is presented. From the image a browning score is extracted along with the water content in the investigated butter cookies. This method, while easy to use and covering the whole surface of the cookies, has a large demand for data analysis, also the equipment was not readily available throughout the project period.

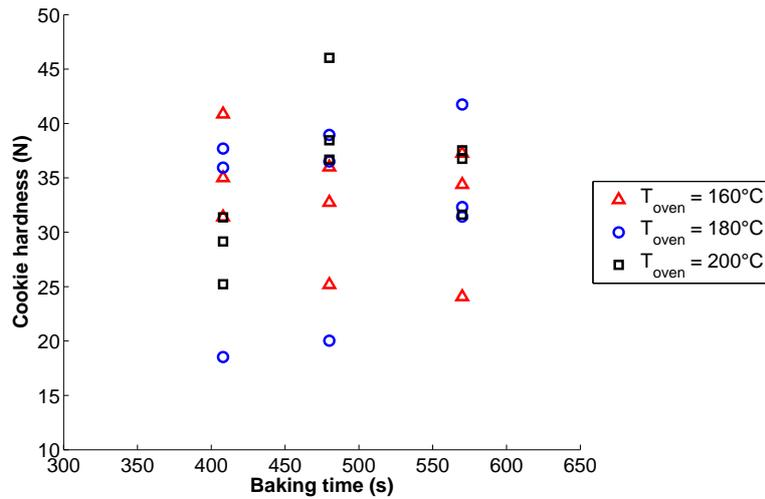

Figure 4.3: Results from a breaking test of butter cookies, three replicas were carried out at each time/temperature combination.

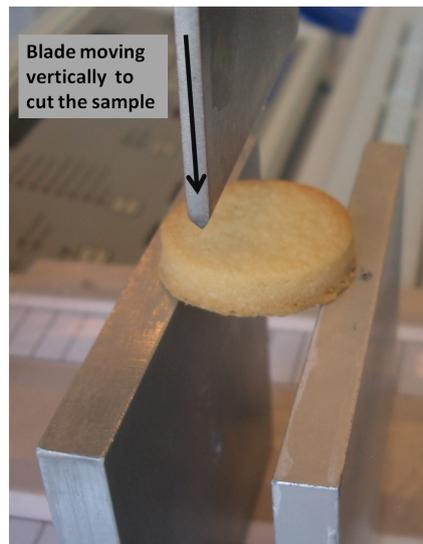

Figure 4.4: Example of a three point bend rig. Photo: by author, March 2009

In Chapter 6 the initial validation of the pilot oven was based on a 6 step browning scale along with mass loss measurements. The advantage of the browning scale is that the entire surface is included and the evenness of browning considered in the evaluation. The evaluation was visual and could be seen as a sensory evaluation. When the article manuscript describing the new oven (Appendix D) was submitted for publication a more quantitative method was required by the reviewers. Therefore an additional method is included. From pictures of the cookies L^* -values from across the surface were extracted for comparison of the two ovens. In the final part of the the oven validation (Section 6.4) the effect of changing the inlet air velocity inside the oven chamber is investigated. In this study the mass loss and is combined with the use of $L^*a^*b^*$ (Minolta colorimeter) measurements on the product surface. Besides the categorization all the applied assessment methods were

chosen to obtain quantitative measures for the variation in the products.

4.3 Multi-spectral image analysis as a quality assessment method

A multi-spectral image analysis method was evaluated as an assessment method for butter cookies. The work was carried out in close collaboration with my colleague Dr. Bjørn Skovlund Dissing. The data processing was primarily performed by Dr. Bjørn Skovlund Dissing, and the experimental work and evaluation of the results in relation to food production were primarily my contributions. An article based on the work has been published online in *Food Science & Nutrition*, June 12, 2013. The work is considered a novel and important part of the PhD project contributions. Due to the different scientific focus in the thesis only a short summary is included in this chapter. For additional information on the study the reader is directed to the full version of the article which is included as Appendix A.

In multi-spectral imaging an image of an object is captured using light in a range of specific wavelengths in a controlled set-up. The reflectance from the object is captured by a camera producing one image per wavelength. Through image analysis information about the characteristics of the object is thereby obtained. A thorough description of the applied multi-spectral imaging system (VideometerLab) is presented by Carstensen et al. (2006).

In the present study the option to obtain information on two different product quality aspects was evaluated. The investigated quality aspects were the surface browning and the average water content in the cookies. The application of an advanced imaging system as the VideometerLab for surface browning determination could be considered exaggerated due to the availability of cheaper methods which are already applied in the bakery industry. However, in combination with determining the water content in the product the method would be very desirable. In McFarlane (2006) methods for product moisture determination are discussed, and an online method with no need for product contact is indicated to be the most desirable method. None of the methods presented in the study were found to adequately measure the moisture.

The idea to use the VideometerLab for both surface color evaluation and water content estimation is based on previous studies of the equipment. The applied VideometerLab has been used to quantify the amount of the red colored astaxanthin in salmonids (Dissing et al., 2011), to measure the water content or degree of agglutination in continuously fried minced meat (Dissing et al., 2009; Daugaard et al., 2010), and as a method to evaluate quality changes in stored wok fried vegetables (Clemmesen et al., 2012). Additionally it is used for product sorting e.g. color sorting of mink fur (Kopenhagen Fur) and monitoring

of shape- and texture-distribution of bulk granule samples (Ferring Pharmaceuticals)².

The investigated product was the same type of butter cookies as used in oven validation and the modeling work. For the application on butter cookies the surface browning was evaluated as a browning score presented as a quadratic response surface. The browning score was calibrated against sensory evaluations of the surface browning, indicating whether the cookies were *under baked*, *adequately baked* or *over baked*. The browning score was translated into a function of the oven temperature (160-200°C) and the baking time (4 - 16 min) shown in (4.1) and Figure 4.5.

$$y = 0.32 - 0.12x_1[\text{min}^{-1}] - 0.13x_2[^\circ\text{C}^{-1}] + 0.008x_1x_2[(\text{min} \cdot ^\circ\text{C})^{-1}] \quad (4.1) \\ + 0.02x_1^2[\text{min}^{-2}] + 0.02x_2^2[^\circ\text{C}^{-2}]$$

In (4.1) x_1 is the baking time in minutes and x_2 the oven temperature in °C.

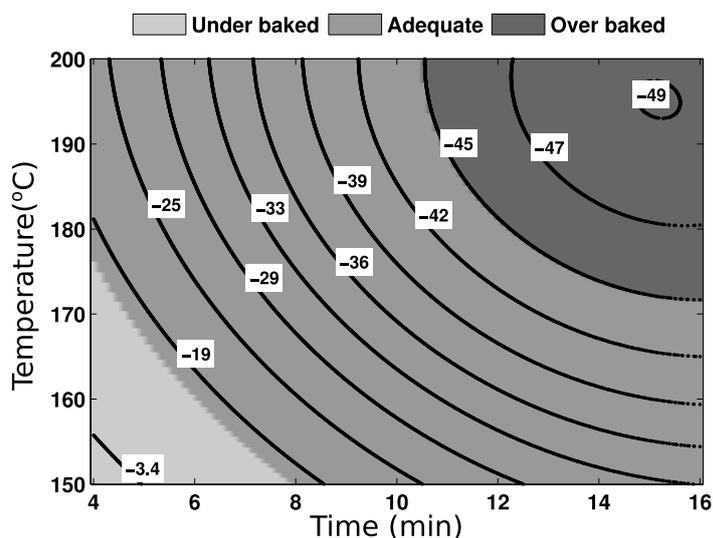

Figure 4.5: The browning score evaluated for the cookie surface as a function of baking time and oven temperature. The zones indicate areas created by the sensory evaluation, corresponding to under, adequate and over baked appearance.

The developed model to estimate the water content was based on water content measurements of baked and cooled cookies which were compared to surface images of the same cookies. Through a principal components analysis of the images sufficient variation was found to predict the water content with good precision. The water prediction model was found to correctly estimate the average water content with an absolute error of 0.22%.

Statistical analysis showed that the most significant wavelengths for browning predictions were in the interval 400–700 nm and the wavelengths significant for water prediction were primarily located in the near-infrared spectrum.

²www.videometer.com, June 12th 2012

It was shown that it is possible to use multi-spectral imaging to assess both the browning and the water content of butter cookies. Furthermore, the method was used to evaluate the browning and water content across the surface of the cookies, giving an indication of the evenness of the process and the produced products. In a production setting, only the relevant wavelengths would be used for monitoring, making image capturing and data processing possible during online production.

4.4 Summary for assessment methods

From the literature study of quality assessment methods evaluation of the product appearance and geometry were found to be the most widely applied methods for biscuit products. These methods are generally fast and easy to perform, and from a manufacturer point of view they are good applicable methods as they may be done online or by the production line. For researchers quantitative version of these methods are preferred, enabling modeling and coupling of mathematical models and the quality of a certain product.

Methods such as dry matter or weight loss measurements are considered more relevant for research or product development than as a tool for quality control. Traditional dry matter measurements is a slow method and not suitable for rapid quality estimates by the production line. Faster methods such as water activity measurements or deduced water content estimates, for example by image analysis, are alternative ways for fast evaluation of the product drying. For online measurements the proposed VideometerLab solution could be a possibility, as it does not require direct product contact.

Through experimental work and measurements it is possible to find a number of correlations between measurements and various changes in the product. However, these correlations are not necessarily representations of causality between measurements and investigated quality aspects. For all quality assessments evaluations of the relevance, the connection to the investigated problem, and a suitable data acquisition method should be carried out. *"An inappropriate test procedure will give poor correlations with sensory assessment and be worthless"* Malcolm Bourne on the use of texture analysis (Bourne, 2004).

In the present work heat and mass transfer has been investigated for a biscuit product. To evaluate these processes, and enable comparison to modeling work, the weight loss, center temperature, and in some studies, surface browning, have been selected as quality assessment methods.

Chapter 5

Design and construction of a specialized batch oven

The work described in this chapter is an elaboration of the first part of the manuscript "Design and Construction of a Batch Oven for Investigation of Industrial Continuous Baking Processes" (Appendix D), accepted for publication in Journal of Food Process Engineering.

A significant milestone in the PhD project was design and construction of a specialized batch oven. The intention of the oven was to create a pilot scale environment capable of baking at similar conditions as found in large continuous tunnel ovens, with the option of product and process monitoring during baking.

Compared to a standard batch baking process the multi-zone tunnel oven offers more freedom for controlling the baking process (Baik, 2000; Mirade et al., 2004). Optimization of continuous baking processes are traditionally performed by trial-and-error, as trained operators use their experience adjusting the process parameters to achieve the desired quality and productivity (Manley, 2011). For both oven manufactures and industrial bakeries, there is a need to gain more systematic knowledge on the impact of the physical conditions in tunnel ovens on both process mechanisms and product quality. Only one study has been found that describes a pilot scale oven designed to reproduce continuous baking processes (Zareifard et al., 2006). This oven is further described in Section 2.3.

The design and construction of the new batch oven was carried out in close collaboration with the manufacturer of large scale equipment for the bakery industry Haas-Meincke A/S, Skovlunde, Denmark. Haas-Meincke A/S is one of the world's leading manufacturers of continuous tunnel ovens and has a great interest in the relations between oven design, the environment in the oven, and the final product quality.

The specifications for the oven were discussed amongst the project partners. The oven should be capable of baking bread, biscuit, and cake products. Based on conversations and discussions at design meetings the following is seen as a rough list of specifications for the oven:

- The oven environment must emulate baking conditions in continuous tunnel ovens within a normal range of temperatures, humidity, and air velocities applied for the investigated products in industrial bakeries.
- It should be possible to vary relevant baking conditions: Temperature, air velocity, air humidity, the distance between convective inlet and the product, and baking tray materials.
- Options to vary between convection and radiation heating, and a combination of these, should be available.
- Monitoring of the baking products must be possible: Product weight, visual inspection, and product temperature.
- Monitoring of the baking process must be possible: Air temperature, air flow, and air humidity.
- Additionally it should be possible to:
 - Varying the baking conditions outside the ranges normally applied in the industry.
 - Enable fast changes of baking conditions (temperature, air velocity, and air humidity), simulating the different baking conditions experienced by a product traveling through a zone divided tunnel oven.

Based on the list of desired functions for the oven, options for the design were discussed. The decision phase was mainly carried out as group brainstorm meetings between DTU and Haas-Meincke A/S. My personal inputs at the brainstorm meetings were focused on the desire for versatility of the oven, the requirements for wide temperature ranges, and the need to switch between radiation and convection heating. Between meetings my main focus was on the air flow pattern along with Haas-Meincke A/S' R&D manager at the time Mr. Søren Skovlund. This work is presented in Section 5.3 introducing the air flow pattern in tunnel ovens, standard batch ovens, and the new experimental batch oven.

The over-all research project, aiming towards a better understanding of tunnel oven baking processes, was initially divided into two phases. The first phase including this PhD work and the construction of the batch oven. The second comprised an expansion of the modeling work, and included an additional pilot scale oven. The future oven has been planned as an approximately 4 - 6 m continuous tunnel oven, with good options for process control and monitoring similar to the initial batch oven. While different design options were discussed for the first pilot oven, its basic nature as a batch oven was a fixed decision.

In the investigated tunnel ovens the product moves through different zones, normally with a length of 2 - 6 m. Each zone has a heating system and the temperature, air humidity, and distribution between top and bottom heating is regulated on zone basis. When products travel through the tunnel oven, different environments may be encountered. Incorporation of the continuous change in baking environment was one of the objectives for the pilot oven design. The convective system and its combination of dampers is estimated to have the capacity to ensure these changes. A full validation of this design objective have not yet been fully investigated.

In the following sections different aspects of the oven design and features are described and discussed.

5.1 The general design of the batch oven

The largest part of the oven is the air heating and recirculation system for the convection heating system. The oven chamber is constructed as a large box in which the baking tray and the heating system are installed. The baking tray is placed on four legs traversing the bottom of the box and placed on a scale. Above and below the baking tray framework air ducts are installed for the convection heating system. The air ducts are placed on a trolley moving from side to side emulating the movement of products through a tunnel oven. In the back of the oven chamber steam may be injected.

The front of the baking chamber box is removable and allows for interior cleaning and maintenance, including adjustment of the distance from the convection inlet holes to the baking tray. In the front panel an oven door is installed. Through this door the baking tray can be placed in the baking chamber and sensors for product temperature logging inserted.

The electric parts of the oven are connected to a control box and controlled either manually at the box or through a computer. The utilized control program, Pjerrot, is specially written for the oven (Mr. Peter Stubbe, DTU Food). It is possible to adjust the temperature in the baking chamber, the movement of the air duct trolley, the humidity in the exhaust air, and the setting of the dampers in the convective air system. The air velocity is controlled manually through a frequency converter connected to the air ventilator. The inlet air setting is manually controlled on a step-less scale from 0 to 10. In Figure 5.1 the interior and exterior of the batch oven are shown from different angles.

5.2 Process control

Three main aspects of the baking process is controllable in the batch oven: The air temperature in the system, the air flow, and the humidity. In this section the possibilities for controlling and following these process properties are discussed and compared to the initial aspirations for the process control in the batch oven.

5.2.1 Temperature measurements

The temperature is measured at three points through the system. In the air heating unit, between the heating unit and the baking chamber, and inside the baking chamber. Two of these measuring points are important for the process: The temperature measurements



(a) Front of the oven (b) Control panel, display on the humidity sensor and air duct trolley motor



(c) Interior of the oven chamber (d) Side view of the oven

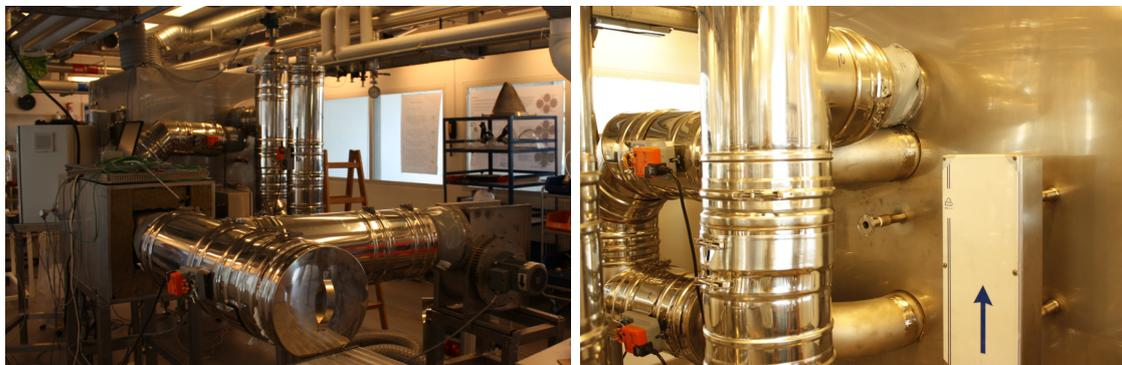

(e) Ventilation system (f) Back of the oven

Figure 5.1: Pictures of the batch oven. (a) shows the front of the baking chamber. The scale for weight measurements and the oven door are visible. (b) show the control box and the motor moving the air duct trolley. (c) shows the inside of the baking chamber when the front panel is removed, the initial wires for radiation heating are seen on the lower air ducts between the inlet holes. (d) shows the window at the side of the oven, and the clamps for removal of the front panel of the oven chamber. (e) shows the ventilation system and the air heating unit. (f) shows the back of the oven, it is seen how the convection air flow is divided into two inlet air streams with individual dampers for flow control to the left, in the center of the picture the exhaust air pipe is seen along with the end of the pipe for steam injection. The connection box for radiation heating is seen to the right.

in the heating unit to avoid over heating and the temperature measured in the baking chamber as this is used as the set-point for baking procedures.

The maximum allowed temperature in the heating unit is set to 600°C, if this temperature is exceeded an automated feedback mechanisms will switch off the heating element.

The temperature inside the baking chamber is measured a few centimeters above the baking tray. The sensor is placed opposite the oven door minimizing the effect of cold air inlet when the oven door is opened or closed.

5.2.2 Heating systems

One of the initial goals for the oven was to enable multiple heating systems, ideally with options for alternating and simultaneous heating. Besides the conduction from the baking tray, arising from a heated baking environment, radiation and convection heating is to be implemented in the batch oven. The convective heating system is working and it is possible to bake with varying air velocity and alternating top:bottom inlet air impact. However, a radiative heating system is not yet functional due to unexpected material related complications. Both systems are described in the following sections, with main focus on the convection system.

Convective heating

The construction of the convective system is modeled around the systems found in Haas-Meincke's indirectly fired convection ovens, a schematic view of this tunnel oven is seen in Figure 5.2 (Haas Meincke A/S, 2012).

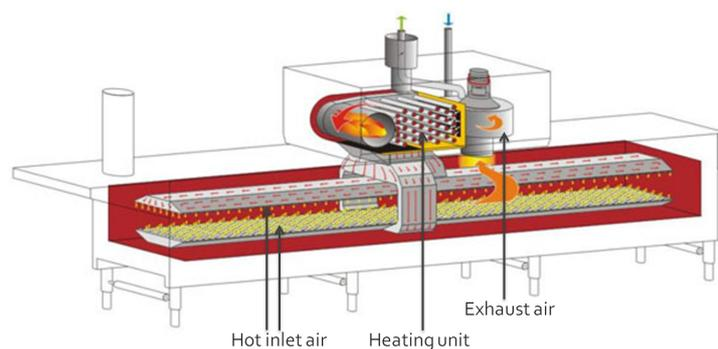

Figure 5.2: Schematic illustration of a standard indirectly heated convection oven (repeated from Chapter 2), (Haas Meincke A/S, 2012).

The main difference between continuous ovens and standard batch ovens regarding air flow is the external heating and air circulation system. In the examined tunnel ovens the air is heated indirectly by passing heated tubes, hereafter the air is distributed in the air ducts above and below the product in each zone.

The inlet air volume per zone is 8000 m³/h. This volume is distributed between the top and bottom air ducts running parallel to the baking band. Each air duct has 700 inlet nozzles per zone. The diameter of the nozzles is 13 mm, resulting in an average linear velocity of 12 m/s when the volumetric airflow is divided by the total inlet area. The inlet nozzles are holes in a stainless steel plate, with a slight curve.

In the new batch oven the air is heated by passing an electric heating element and enters the baking chamber through air ducts above and below the baking tray. Two air exhaust areas are positioned along the front and back of the top air duct. Figure 5.3 shows a schematic illustration of the air ventilation system along with a picture of the baking chamber seen from the side.

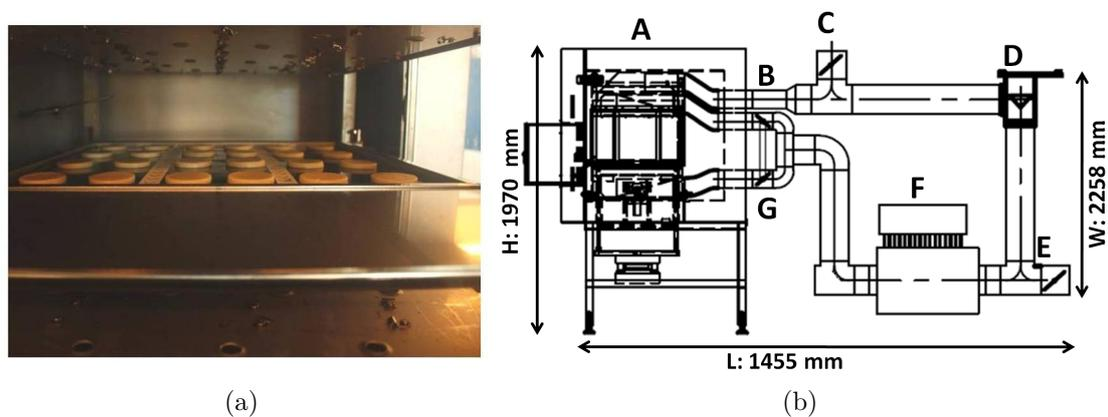

Figure 5.3: (a) A photography of the baking area in the oven chamber. (b) A schematic illustration of the batch oven. The left part (A) is seen from the side, while the rest of the illustration (B - G) is seen from above. H is the height of the oven chamber, L the length of oven chamber and air system, W the width of the oven chamber and air systems. A - oven chamber, B - humidity sensor, C - fresh air inlet, D - ventilator, E - air exhaust, F - heating unit, G - ducts adjusting top and bottom inlet air.

The air duct nozzles are positioned in a staggered pattern based on the tunnel oven design. The number of inlet nozzles per zone is constant and independent on the zone length. The number of nozzles in the batch oven correspond to approximately 5 % of a tunnel oven zone. The pattern would thus be suitable in an oven zone approximately 5 m long and 1.5 m wide. The pattern and dimensions for the batch oven are shown in Figure 5.4.

To avoid spot burning and to simulate the movement of the baking band through the tunnel oven, the air ducts are movable. The movement (left-to-right) may be up to 0.1 m in each direction, equaling the distance between two nozzles on the same horizontal line. For the product this distance of oscillation will correspond to traveling through a tunnel oven giving a uniform exposure to the hot inlet air across the baking tray.

The differences in the product movement in a tunnel oven and the batch oven were considered. In the batch oven the movement will be oscillating, while the movement in the tunnel oven will be continuous in one direction. In other studies, such as (Baik and Marcotte, 2003) the air velocity around the product has been expressed as a "relative

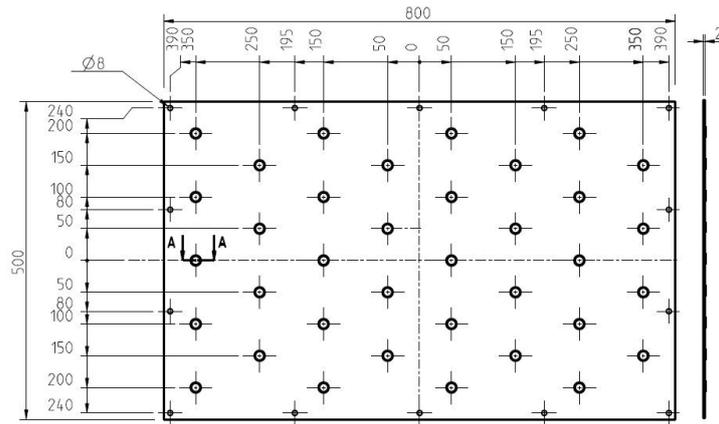

Figure 5.4: Dimensions of the inlet part of the air ducts, distances given in mm. The upper air duct has outlet suction along the two 800 mm sides.

air velocity". The movement of the baking band has been shown to influence the air flow pattern around the products, when the overall air flow velocity is low, as seen with natural convection. In the present case forced convection is studied. With the estimated average linear inlet air velocity of 12 m/s and a band velocity of 0.02 m/s (= the velocity for a baking time of 8 min in the 10 m oven), the inlet air velocity is around 600 times that of the product. Therefore the effects of a side-to-side movement versus the one-directional movement, should not influence the air flow pattern significantly (Senter and Sollic, 2007). The movement does prevent spot burning and is needed in the batch oven as explained in Section 5.3 and Figure 5.7. In the batch oven the air velocity is adjustable on a step-less 0 - 10 scale. A feature which is not seen in the reference tunnel ovens or, to the authors knowledge, in other pilot scale ovens for investigation of tunnel oven processes.

Dampers are used to direct the air flow through the top and bottom air ducts. This option is also available in the reference Haas-Meincke convection ovens. Additionally the distance from the air ducts to the baking tray may be adjusted. The adjustable distances are 0.01 - 0.27 m above and 0.03 - 0.15 m below the product. From personal communications with Haas-Meincke employees, it is known that the standard distance between the baking product and the inlet nozzles above the product is approximately 0.07 m in convection tunnel ovens.

Radiation heating

In tunnel ovens radiation heating is either obtained directly from burners in the oven chamber or indirectly by heating of tubes or surfaces in the oven chamber. In the pilot oven an indirectly heating method was chosen, which could be heated electrically, and not by direct fire in the pilot plant.

Two main options were considered. One was to heat an un-perforated plate using the

convective air system for heating, the other to install a grill-like wire system between the nozzles for convection heating. The first option have the advantages of an evenly heated surface, resulting in a nearly uniform radiation, and the option to have a measurable and controllable radiation temperature. However, the disadvantage of not being able to quickly switch to convection heating or baking with a combination of radiation and convective heating, resulted in this solution being discarded.

An electric wire system was chosen and installed in the oven. Metal wires with a diameter of approximately 3 mm were placed on the air ducts between the inlet nozzles. In Figure 5.3(a) one may see the small hooks used to hold the wires in place.

Before the batch oven was moved from Haas-Meincke A/S' construction facility to DTU it was unfortunately discovered that the material used for the wire connection was not compatible with the air duct movements from side to side. At present the system has not yet been rendered functional and it has not been possible to conduct any baking experiments with radiative heating.

Considering the future prospects of the oven a system utilizing the already existing convection system should still be considered. A rack-like system for movable plates could be installed above and below the convection nozzles. While changing between convection and radiation would require the oven door to be opened which will disturb the temperature and humidity, the system would be better controlled compared to wire heating. Due to the nature of radiation heating, the temperature of the wires is important in order to estimate the impact on the baking product. Measuring the air temperature in the baking chamber alone would not give sufficient information on the relation between radiation heating and the product quality. If an indirect radiation system, utilizing the convective system was implemented the air temperature at the radiation plate would correspond to the temperature of the plate. Hopefully a solution will be found in the future so that the oven will be able to fulfill more of its original purposes, and allow a broader range of experiments.

5.2.3 Air humidity

The air humidity is measured in the exhaust air collected at the sides of the top air duct. A Yokogawa High Temperature Humidity Analyzers type ZR22G-040 (Japan) is installed immediately after the oven chamber. The signal is recorded on the control computer.

At the back of the baking chamber an inlet pipe is placed, enabling steam injection into the oven chamber. The steam injection is controlled through the control system so that a specific level of air humidity is maintained during baking. As is the case for the temperature regulation a pre-designed humidity program can be applied, for example starting the baking process with a high level of humidity and then finalizing the baking in a dry environment.

The steam injection system was not ready to use when the main baking experiments

related to this work were conducted. Later experimental work with Swiss roll cakes have shown a good ability to keep an even air humidity, even though the oven was found to have many leaks (Møller, 2012).

Air humidity is an important aspect in many baking processes and for the purpose of understanding continuous baking processes the steam injection system is a vital addition to the batch oven.

5.3 The inlet air flow

The inlet air ducts in the batch oven have been specially designed to simulate the air flow found in convection tunnel ovens. For comparison I made CFD simulations showing the air flow in a standard laboratory convection oven, a tunnel oven, and the new pilot batch oven. The CFD simulations of the laboratory oven and the single inlet nozzle are made in the finite volume simulation program Fluent 6.3 (Ansys). The CFD simulation of the new pilot oven is made in the finite element program COMSOL Multiphysics 4.3 (COMSOL, 2012), applying the $k-\omega$ turbulence model. Finite element modeling is further described in Section 8.2.

The standard laboratory batch oven has an internal heating element and a fan creating a convection air flow by recirculation. Due to the fan the air flow pattern is constant and the air moves horizontally across the baking tray (right to left in the illustration), see Figure 5.5(a). The air velocity was measured at the left side of the chamber with an anemometer. The linear average velocity of several measurements was used as the inlet boundary conditions.

The CFD simulation of the tunnel oven includes the air flow from a single nozzle Figure 5.5(b). The flow conditions above the inlet nozzle in the air duct is partly included in the simulation. The inlet air boundary conditions are based on volumetric air flow, resulting in an average inlet velocity of 12 m/s through the nozzle.

Figure 5.6 shows half the cross sectional area of the pilot oven at a position with five inlet nozzles in a row. In the simulation the inlet air velocity is set to 12 m/s at the nozzles. In order to run the simulation simplifications of the oven geometry were necessary: The nozzle is designed as a hole in the surface above the product, in the actual oven the nozzle as a small curvature (as seen in the simulation of the tunnel oven nozzle); the air flow in the above air duct is not included; and the outlet is simplified to constitute the whole right side of the illustration, instead of being positioned at the top right side next to the outer inlet nozzle. Even with the simplifications the simulation is considered a good indication of the air flow in the pilot oven when the air ducts are stationary. The simulation shows how the air flow reacts around three cookies positioned on the baking tray. The dominating flow close to the cookies is mostly parallel to the upper surface, some turbulence and varying local velocities are seen around the edges of the cookies. The latter showing that further work with CFD modeling may improve the understanding of

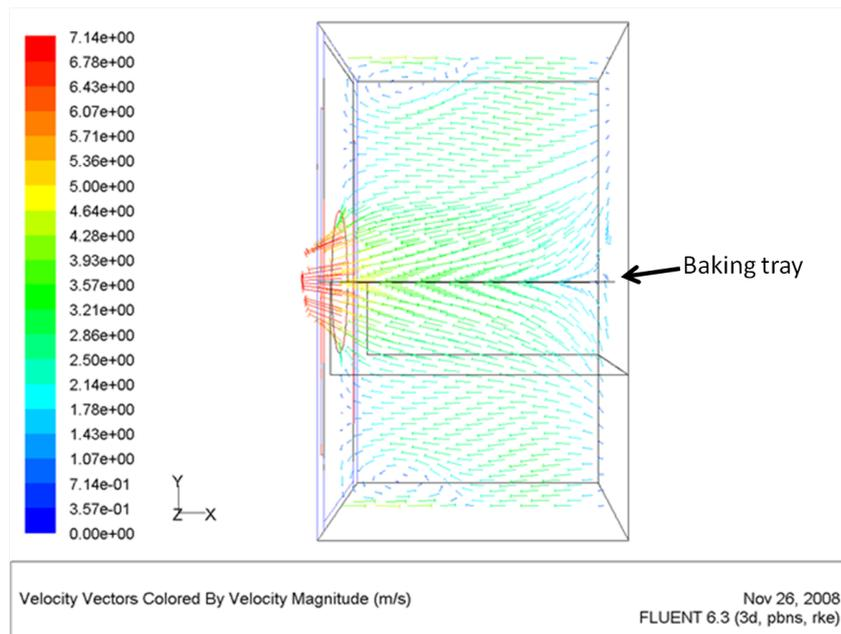

(a) Air flow in standard batch oven.

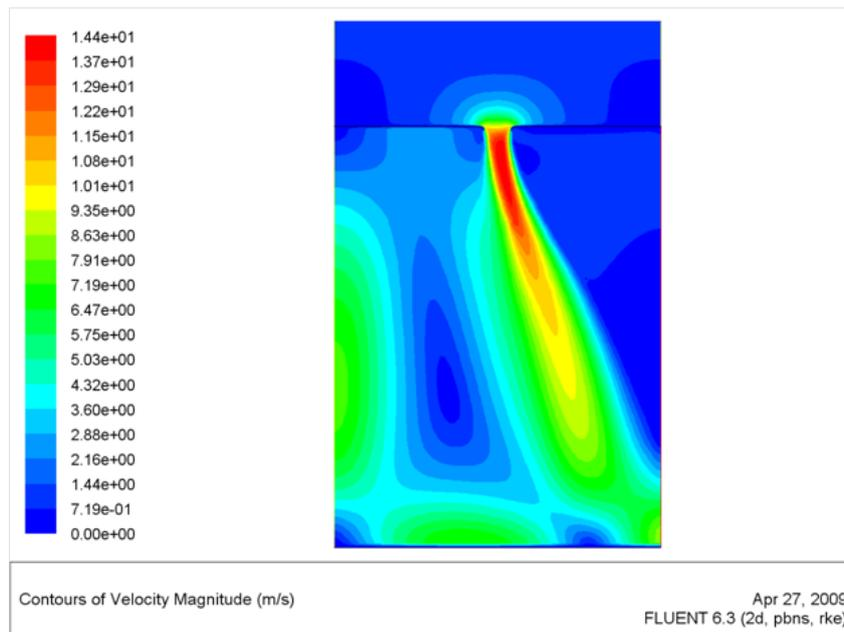

(b) Simulation of the air flow through one inlet nozzle in the tunnel oven.

Figure 5.5: (a) Air velocity and directions in a 3D simulation of the air flow pattern in a standard batch oven for production kitchens (Rational CCC oven) (by Mette Stenby Andresen, 2008). (b) A 2D simulation of the inlet air flow through one nozzle in a tunnel oven (by Mette Stenby Andresen, 2009).

local heat and mass transfer properties.

During baking the air flow will vary perpendicular to the plane of the illustration, as the air ducts move from side to side. From this movement and the staggered pattern of the

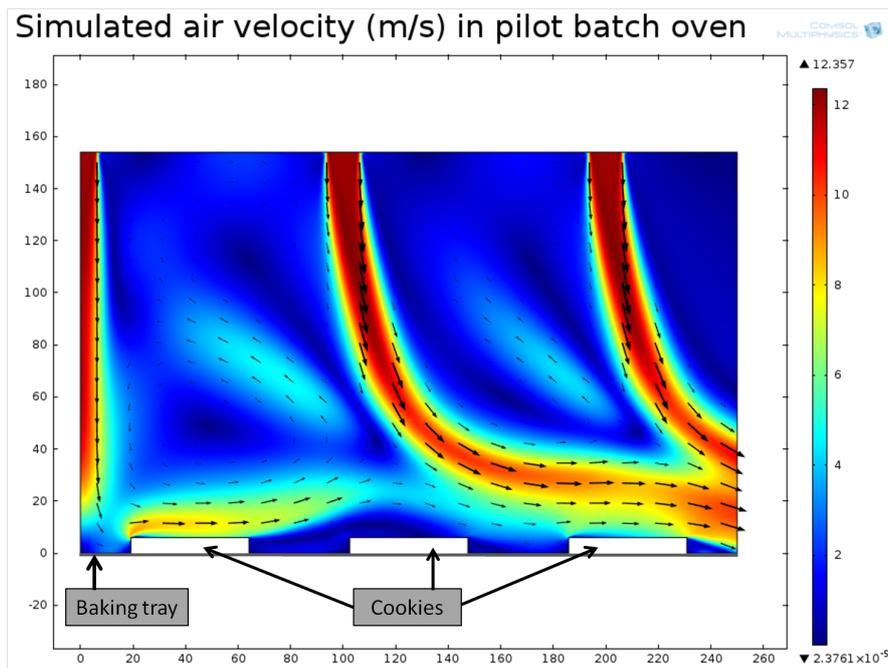

Figure 5.6: A 2D simulation of the inlet air velocity in half the cross sectional area of the pilot oven. The colors indicate the air velocity the arrows the air flow direction. The outlet is set as the entire right side of the domain to simplify the calculations (by Mette Stenby Andresen, 2013).

inlet holes (varying from 4 to 5 per row, Figure 5.4) an even air flow is achieved across the products. An example of a sheet of cookie dough baked with no movement is shown in Figure 5.7. The need for side to side movement is clear from the resulting "spot burning" below the inlet nozzles.



Figure 5.7: A section of a sheet of butter cookie dough baked in the pilot oven with no movement of the air ducts. The horizontal distance between the center of the spots is approximately 0.1 m.

The simulations of the tunnel and pilot ovens show that the inlet air flow from the nozzles have some of the qualities associated with jet flow. Jets can be divided into three regions, a free jet region in which the air jet is behaving as a free jet, a stagnant zone, where the jet meets the surface and a radial spread zone on the surface itself (Sarkar and Singh, 2003). However, considering the simulation of the batch oven, a clear jet behavior is only seen below the center inlet nozzle. Below the two adjacent nozzles the air flow is curving towards the outlet.

The additional disturbance created by the side-to-side or forward movement is not included in the simulations. Considering both the simulated air flow patterns and the product or air duct movement the air flow is considered a convective air flow, but not an impingement or jet dominated flow.

Compared to the laboratory oven the air flow in the pilot oven is highly adjustable. In the pilot oven the distribution between the top and bottom air ducts is adjustable as is the velocity of the inlet air. The effect of varying the inlet air velocity is further investigated in Chapter 6.4.

Further understanding and accuracy of the simulations will be obtained when an air flow measuring system is installed in the oven. Air velocity values presented in this work are either based on estimates from Haas-Meincke A/S or measurements with an anemometer by the inlet nozzles. Installation of a pitot tube or similar system in the convective system will provide valuable information about the air flow, and provide more accurate estimates of the inlet air velocity.

5.4 Product monitoring

During baking the product and its development may be followed on several levels. The product weight is recorded continuously, the product temperature can be measured by the use of external additional temperature sensors, and visual inspection is possible through the window in the side of the baking chamber and the baking chamber door.

In the following sections the possibilities available today by using these monitoring options are described and discussed.

5.4.1 Product weight

The baking tray and its support structure is placed on a scale, Signum Suprime level 1 (Germany), with a capacity and precision of $35 \text{ kg} \pm 0.1 \text{ g}$. The relative high capacity of the scale is chosen so that it is possible to bake with different tray materials. This will enable future projects investigating the effect of the baking tray material on bakery product development. For example to study the difference between baking on a stone surface contra ceramic coated stainless steel has been discussed as a possible area of interest.

During baking the air ducts are moved from side to side on a trolley inside the oven chamber. The track for the trolley is not completely even and at the end-points, especially in one side, the trolley causes the baking tray to lift. Along with the effects from the convection air system this creates noise on the product weight measurements. Figure 5.8 shows measurements from a 8 min baking at medium air velocity. In Figure 5.8(a) all measuring points are included in Figure 5.8(b) only the measurements between 3.45 - 3.50

kg are shown (the weight measure is for 12 cookies and the baking tray).

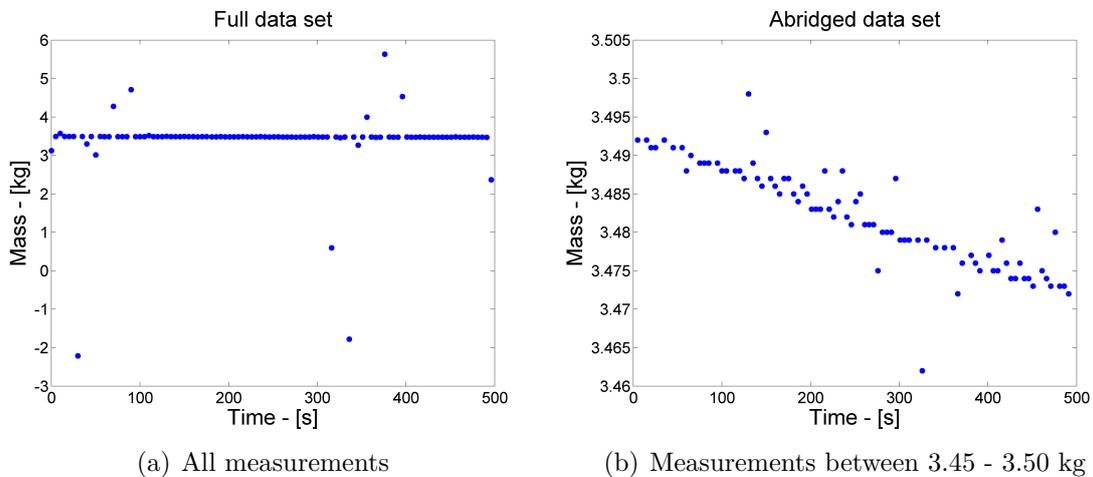

Figure 5.8: Weight measurements from the new batch oven (cf. this is one of the data sets show in Figure 8.3).

It is seen that it is possible to follow the loss during baking even with a few samples. The initial weight of 12 butter cookies is approximately 150 g. Although the steering of the trolley needs further work, continuously obtained data is used in the presented modeling work to validate and improve the mathematical model of the baking process (Chapters 8 and 9).

5.4.2 Product temperature

Grooves are milled in the oven door frame to allow easy passage of sensor cords. In the presented work the temperatures of butter cookies were logged through an additional computer due to the number of sensors needed. If only a few sensors are needed, it is possible to use sockets attached to the control computer. The measurements are then included in the same output file as the oven temperature, air humidity, and weight measurements.

In this work sensors have been used to measure temperatures in two cases; for estimation of heat transfer coefficients and for validation of the mathematical model.

5.4.3 Visual inspection

Through the window at the side of the baking chamber it is possible to follow the product visually during baking. The window is installed to allow for fixed installations for video or photography capturing equipment. The window is one layer glass which minimizes the distortion in a picture. However, having only one layer of glass also results in a high surface temperature, which should be considered when choosing and setting up a visual recording system.

The experimental work have not yet included visual quality measurements during the baking process. The task of setting up a suitable visual recording system, ensure correct light, and doing the final image analysis was outside the scope of this PhD project.

5.5 Summary of oven design

The oven is considered a valuable tool for controlled experiments with flexible options for following the product during baking. The design was made in collaboration between DTU and Haas-Meincke A/S with the scope of fulfilling the specifications listed in the beginning of this chapter. Solutions for all the specifications were included in the initial design. Only the option to vary the heating mechanism between convection and radiation heating has yet to be implemented.

In contrast to other experimental pilot ovens the new oven is constructed to fulfill two specific goals. It is possible to emulate continuous baking processes, and it is possible to follow the product closely during baking. The option of continuous weight measurement has only been found in two published studies describing pilot ovens (Lostie et al., 2002a; Sommier et al., 2005). In Lostie et al. (2002a) a scale is positioned above the baking chamber and connected to wires holding the product inside the oven chamber. This solution has also been attempted at DTU in the old laboratory convection oven, however, with limited success, due to disturbances from the air movement. The solution selected in the present work with the scale positioned outside the baking chamber, under the baking tray, allows for moving air ducts and the necessary convection air flow. Some noise has been unavoidable due to steering problems with the air duct trolley (cf. measurements shown in Section 5.4.1, Figure 5.8(a)). Hopefully new wheels and better steering will improve the accuracy of the weight measurements of bakery products during baking.

After the oven was assembled at DTU in the early spring of 2011 the validation process was initiated. Validation of the oven's ability to heat and bake evenly, to bake products similarly to a tunnel oven, and to vary the inlet air velocity is described in Chapter 6.

Chapter 6

Validation of the batch oven

The work described in this chapter is an elaboration of the last part of the manuscript "Design and Construction of a Batch Oven for Investigation of Industrial Continuous Baking Processes" (Appendix D), accepted for publication in Journal of Food Process Engineering. Additional experimental work examining the impact of varying the inlet air velocity within the available range of the oven is presented. These results were presented at the 11th Conference of Food Engineering, Leesburg VA (USA), arranged by VirginiaTech, Tuesday the 3rd of April 2012.

The initial validation of the batch oven focus on two main elements. The first element is related to the batch oven itself, investigating its ability to heat and bake evenly across the baking tray. The second element is a comparison study between the batch oven and a convection tunnel oven. The validation work related to these two elements is presented in this chapter along with the applied methods. The investigation of even heating and baking was carried out by the author, and some of the experimental baking work considering comparison between the batch oven and a tunnel oven was carried out in collaboration with two internship exchange students (Bram Schellekens and Harold Verhulst, HAS Den Bosch).

6.1 Quality parameters for the validation experiments

The product quality parameters applied in the baking tests are product color and weight loss. These two quality parameters were chosen as they represent both the heat and the mass transfer processes taking place during baking. The mass loss is further investigated in the modeling section of this thesis. While the build-in scale is used in the later experimental work for the modeling this was not possible in the validation studies. Off-line weight measuring was used because of the lack of online weight measuring in the tunnel oven. In the validation experiments the weight loss was found as the total loss considering both baking and cooling.

In the first two steps of the validation the color was evaluated both visually and by image analysis of the surface color. The visual evaluation system is based on comparison to pictures of cookies representing a 6 step scale (1 - 6) showing increasing degrees of browning (Figure 6.1). If a cookie was assessed between two categories it was systematically assigned the lowest value. Cookies which are ranked below 1 are not baked through. Categories 1 through 5 indicates increasingly browning cookie surfaces. Cookies in category 6 are starting to scorch, these are considered not-acceptable.



Figure 6.1: Standard grading of cookies, according to the degree of browning. Cookies baked less than group 1 are not considered baked through and cookies darker than group 6 are considered burned.

The subjective categorization of the products is a fast and global evaluation method. Similarly to the objective image analysis method described in Section 4.3 the whole surface of the product is taken into account. In the initial phase of the validation work only the categorization was applied for quality assessment of the browning, due to the method being both fast and including the impression of the whole product surface. In the review process of the manuscript “Design and Construction of a Batch Oven for Investigation of Industrial Continuous Baking Processes” (Appendix D) an objective method was added. Fortunately pictures had been captured of some of the butter cookies in question along with a reference color matrix. Photographs of the cookies used for comparison of the batch and the tunnel oven were available for image analysis.

For the objective photographic method the L^* -value in the CIE $L^*a^*b^*$ system was used. This measure for browning has been widely applied by other researchers (Baik, 2000; Ahrne et al., 2007; Zanoni et al., 1995; Purlis and Salvadori, 2009). Using Adobe Photoshop Lightroom 4 and Picture Windows Pro v. 6.0.9, by Digital Light & Color, corrections were made for the lightning and a blur was laid across the cookie surface. The average L^* -value of 9 pixels was measured at 4 points at a distance of approximately 1/3 of the way from the edge to the center, and at the center. The image analysis was carried out by associate professor JÄ_rgen Risum, DTU Food. The average of these 5 points gives a measure for the surface lightness and the standard deviation a measure for the variation across the surface for each cookie. The measurements were obtained in points across the surface to try to incorporate the effect arising from uneven browning of the cookie surfaces.

In the experimental work considering changes in the inlet velocity the surface lightness was measured as the L^* -value with a CR-200 colorimeter, Minolta (Japan). The lightness was measured as the average of three points on the surface of the cookies, the measurements points are shown in Figure 6.2. An average value is chosen to represent the whole surface

as the browning takes place from the edge towards the center.

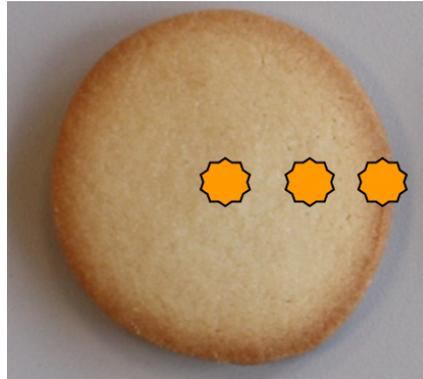

Figure 6.2: Positions for lightness measurements.

6.2 Uniform heating and baking in the batch oven

The oven's ability to heat and bake evenly was investigated in two steps:

1. Measurements of the local heat transfer coefficients across the baking tray.
2. The browning of cookies across the baking tray.

6.2.1 Estimating the heat transfer coefficient

The average heat transfer coefficient was used to examine the uniformity of the air flow and thereby the convective baking conditions across the baking tray. The heat transfer from a fluid to a solid body is a function of the air velocity around the body, the thermo-physical properties of the air, and the geometry of the body (including the surface roughness). This relation is conventionally expressed through the dimensionless Nusselt's number (Nu), the Reynold's number (Re) and the Prandtl's number (Pr). The Nusselt's number can be seen as a dimensionless expression for the heat transfer coefficient. Expressions for the Nusselt's number, the Reynold's number, and the Prandtl's number are given in (6.1)-(6.3).

$$Nu = \frac{h_T D_h}{k_f} \quad (6.1)$$

$$Re = \frac{v D_h \rho}{\mu} \quad (6.2)$$

$$Pr = \frac{C_p \mu}{k_f} \quad (6.3)$$

where $h_T \left[\frac{W}{m^2K} \right]$ is the heat transfer coefficient, $D_h [m]$ the characteristic length of the investigated body, $k_f \left[\frac{W}{mK} \right]$ the thermal conductivity of the fluid, v the air velocity $\left[\frac{m}{s} \right]$, ρ , μ , and c_p are the density $\left[\frac{kg}{m^3} \right]$, viscosity $[Pa \cdot s]$ and heat capacity of the air $\left[\frac{J}{kgK} \right]$, respectively.

The general form of Nusselt's relations for gas heating of an object by forced convection can be written as $Nu = k(Re)^n(Pr)^m$, where k , n , and m are empirically determined constants depending on the air flow properties. A relation for gas cross-flow around a cylinder is given in (6.4) (Rathore and Kapuno, 2011). This relation shows how the Nusselt's number, and thereby the heat transfer coefficient, can be calculated from the Reynold's and Prandtl's numbers.

$$Nu = 0.19Re^{0.6}Pr^{0.3} \quad (6.4)$$

Due to local turbulence in processes with complex air flow it is very difficult to estimate the local air velocity by the product accurately through experimental measurements (Carson et al., 2006). Instead a lumped capacitance model can be used to calculate an average heat transfer coefficient. This method does not directly measure the air velocity, instead the flow properties and the heat transfer coefficient are deduced from the experimentally obtained temperature data. The method is described below.

The governing hypothesis in the lumped capacitance model is that the temperature through a body with a Biot number $\left(\frac{h_T D_h}{k_p}, k_p \text{ is the thermal capacity of the product } \left[\frac{W}{mK} \right] \right)$ below 0.1 (preferably <0.01) is uniform. In this situation (6.5) can be used to calculate the heat transfer coefficient (Carson et al., 2006; Mills, 1995; Nitin and Karwe, 2001; Sakin et al., 2009).

$$h_T = -\ln \left(\frac{T_s - T}{T_s - T_0} \right) \frac{mc_p}{At} \quad (6.5)$$

where T_s is the temperature of the surroundings $[K]$, T the product temperature $[K]$, T_0 the initial temperature $[K]$, m the mass of the disc $[kg]$, c_p the specific heat capacity of the disc material $\left[\frac{J}{kgK} \right]$, A the surface area $[m^2]$, and t the heating time $[s]$.

For the cylindrical butter cookies used as experimental product the characteristic length is the diameter. The thermal conductivity is in the area of $0.2 \frac{W}{mK}$ (based on dough composition (Choi and Okos, 1986)). The Biot number of the cookies will exceed 0.1 when the heat transfer coefficient is higher than $0.44 \frac{W}{m^2K}$. This values is far below values for still air, in which heat transfer coefficients in the range of $5-10 \frac{W}{m^2K}$ are usually reported (Singh and Heldman, 2009). The heat transfer coefficient in the investigated process will be much higher than $0.44 \frac{W}{m^2K}$. Therefore a significant temperature gradient will be present in the cookies during baking, and they cannot be used to estimate the heat transfer coefficient by use of the lumped capacitance model.

The thermal properties of an object does not influence the average heat transfer coefficient. Therefore a different material with a high thermal conductivity can be used to calculate

the average heat transfer coefficient. The substitute material in the following is aluminum which have proven a good material for heat transfer studies (Nitin and Karwe, 2001). The thermal conductivity of aluminum is approximately $170 \frac{W}{mK}$, thus the Biot number is below 0.01 as long as the heat transfer coefficient does not exceed $230 \frac{W}{m^2K}$, and the conditions for (6.5) are fulfilled. To keep the conditions as similar as possible to the actual baking process the standard baking tray was used without insulation or other modifications. The baking tray was cooled before the measurements in order to minimize excess heat transfer from a pre-heated baking tray. The average heat transfer coefficient was measured at 24 points across the baking tray.

With the intention of maintaining the dimensions of the original product for heat transfer estimation small aluminum discs were made with a diameter of 45 mm and a height of 6 mm. Unfortunately this geometry resulted in a too rapid heating. During the time needed for the oven to reach steady state the temperature of the cookie shaped aluminum increased almost to that of the oven air. For the lumped capacity model to be valid the oven temperature must be constant. Therefore another solution had to be found.

Compromising on the total dimensions larger cylinders were produced, with a diameter of 40 mm and a height of 60 mm. The larger cylinders did not reach the oven temperature before a steady state air temperature was reached. The results were used to estimate the overall heat transfer coefficients for the validation work, and applied in the following modeling work (Chapter 8). For a flow pattern which is roughly perpendicular to the cylinder, the characteristic length is the diameter of the cylinder. Because the characteristic lengths of the high cylinders (40 mm) and the cookies (45 mm) are approximately the same, the estimated heat transfer coefficient was used in the modeling work. It is possible that the determination of the values could be improved with a closer geometric similarity or a different measuring method, possibly heat flux measurements on the baking tray or by simulation (e.g. computational fluid dynamics) of the air flow in the oven chamber. For the validation work the point of interest is the evenness of heating across the baking tray, differences in the geometry of the investigated objects do not influence the validity of this work.

A linear regression of the logarithmic temperature difference against the time is used (see Figure 6.3). The present oven needs time to adjust the temperature after the door has been opened. Therefore the model should only be applied to the measurements obtained when the oven is in steady state. For the data shown in Figure 6.3 this is the case at $t \geq 300$ s.

The air velocity in the pilot oven is adjustable, as described in Chapter 6.4. It is known that the air velocity influences the heat transfer coefficient (Nitin and Karwe, 2001). In order to get an impression of the oven's window of operation the heat transfer coefficients over a range of air velocity settings were found.

Initially the batch oven settings were adjusted so that the center setting matched a 10 m tunnel oven used for other comparison experiments. The air velocity in the batch oven is

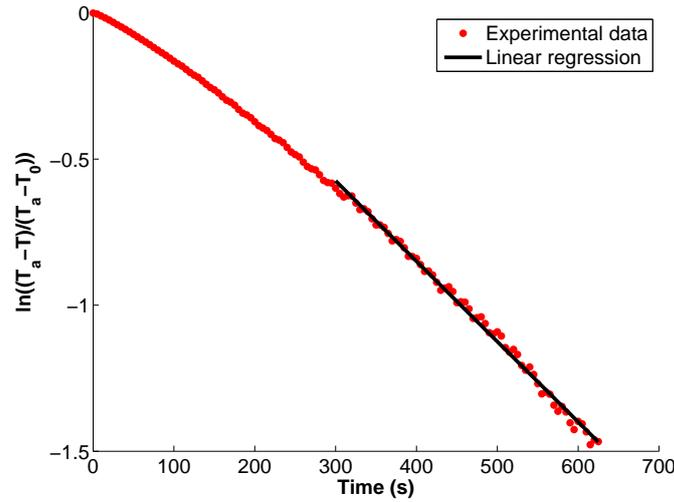

Figure 6.3: Example of experimental results combined with the calculated linear regression based on Equation (6.5) for $t \geq 300$ s.

adjustable on a stepless scale from 0 - 10. In the present experiment setting 5 was used as the reference point to the tunnel oven. The average heat transfer coefficients were found for velocity settings 1, 3, 5, 7, and 9. Three measurements were carried out at each air velocity. The found heat transfer coefficients are shown in Table 6.1 along with standard deviations over the three repetitions. In the present work the value found at setting 5 is applied in the simulation work.

The relation between velocity settings and volumetric flow is not known until a volumetric measuring system is installed in the oven (cf. Section 5.3). When this relation is established it will be possible to calculate a proper Nusselt's relation based on these and additional measurements.

Table 6.1: Heat transfer coefficients calculated for the batch oven at 5 different inlet air velocity settings.

Velocity setting	$h_T \left(\frac{W}{m^2K} \right)$	SD $\left(\frac{W}{m^2K} \right)$
1	50	1
3	57	2
5	63	1
7	69	1
9	72	2

6.2.2 Baking experiments for uniform browning

Butter cookies were baked in 24 different positions across the baking tray, after baking the uniformity of browning was evaluated as described in Section 6.1. The cookies were prepared following the recipe given in Table 6.2. The positions of the cookies were the

same as those used to find the heat transfer coefficients.

Table 6.2: *Composition and mixing procedure for 1.7 kg cookie dough.*

Ingredients	Mass (g)
Icing sugar	333
Margarine	500
Vanilla extract	3.3
Mix until even texture	
Whole egg	33.3
Skimmed milk powder	12.5
Salt	3.3
Sodium bicarbonate	0.4
Water	8.3
Mix until even texture	
Corn starch	167
Wheat cake flour	667
Mix until an even textured dough is obtained Finish by gathering the dough by hand	
Total weight	1728

The oven settings for both the investigation of even heating and the browning experiments were: Equal top:bottom inlet air distribution, with dampers opened to 50%, air temperature at 170°C, and for the baking experiments a baking time of 8 min. After baking the browning was evaluated based on the 6 step scale only. The distance from the upper inlet nozzles to the product was set to 15.4 cm, and the distance from the lower inlet nozzles to the baking tray was 8.2 cm. The distances from the inlets to the baking tray were chosen based on the distances in the tunnel oven used for the comparison experiments.

6.2.3 Results for heating and baking uniformity

The average heat transfer coefficient measured with the lumped capacity method from the 24 measuring points across the baking tray was $62 \frac{W}{m^2K}$ with a relative standard deviation of 4.5%. An overview of the values as they are distributed across the baking tray is shown in Figure 6.4(a). The total variation is small and indicates uniform heating across the baking tray; no systematic variations were seen over the measured area.

Cookies baked in the same positions and under the same conditions as used for the heat transfer coefficient measurements are shown in Figure 6.4(b). The investigated cookies were ranked in category 2. The category based results are thereby in agreement with the heat transfer coefficient measurements. It is found that the small variations measured for the heat transfer coefficients do not reflect in the browning of cookies across the baking tray.

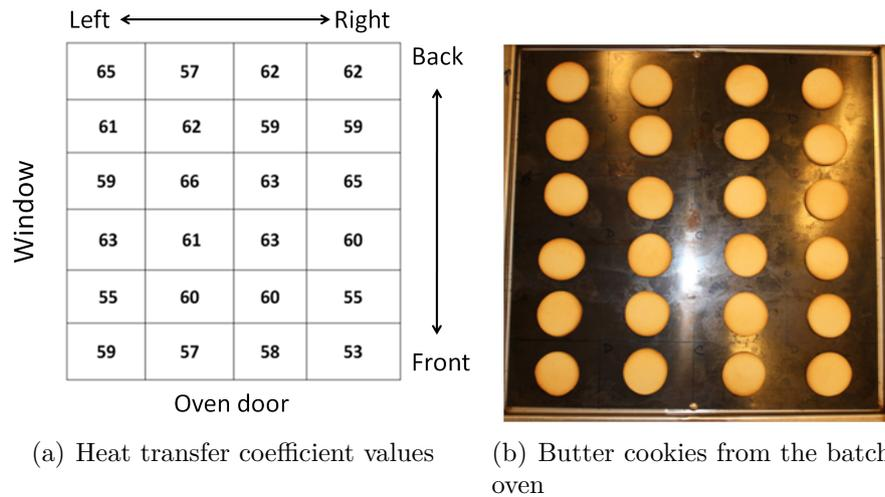

Figure 6.4: (a) The measured heat transfer coefficients ($W/(m^2 K)$). The orientation in the oven is given as “front/back”, “left/right” and the positions of the window and the door are indicated. (b) Cookies baked in the batch oven at the same positions as the heat transfer coefficients are measured.

6.3 Comparison between batch and tunnel ovens

When similar settings are used in the batch oven and a tunnel oven, comparable product qualities must be obtained. Butter cookies, prepared as described in Section 6.2.2 were used for the comparison experiments. The oven parameters used as set-points were: The temperature by the band or baking tray, the inlet air velocity, the distribution between top:bottom inlet air, the air duct to band distances, and the baking time. Browning and the total weight loss were used as product quality parameters and measured as described in Section 6.1.

The robustness of the reproducibility was tested by changing one of the processing parameters, the air temperature. The investigated temperatures were 160°C, 170°C, 190°C, and 200°C.

A 10 m indirectly fired convection tunnel oven was used as reference oven. The two zones of the oven were set at the same temperature and inlet air distribution in all the reported baking experiments. It was possible to measure the temperature just above the baking band during processing. This was done through a hatch halfway down the length of the oven. Measuring the air velocity was more complicated. It was not possible to reach a sufficient number of inlet nozzles through the hatch, therefore two maintenance panels needed to be removed to gain sufficient access and the measurements were carried out at room temperature. The change in temperature will only affect the flow pattern slightly (Marcroft et al., 1999). Accordingly, the velocity adjustments in the batch oven were done at room temperature.

When the air enters the baking chamber through the inlet nozzles the air flow pattern be-

comes diffuse and does not follow a fully developed flow pattern. Two types of anemometer sensors were tested in the pre-experimental work, a rotating vane and a pitot tube connected to a Testo 400 logging unit, Testo AG, Germany. To focus the inlet air stream a plastic tube was used to frame the inlet hole during measurements. While the distance between the band and the inlet nozzles did not allow for the flow to be fully developed, it increased the accuracy of the velocity measurements.

While good reproducibility was seen between the different nozzles and repetitions at the same nozzle (see Section 6.3.1), there was a clear difference between the results from the two sensors. The measurements with the vane probe only showed an average inlet velocity around $2 \frac{m}{s}$ while the pitot tube showed an average inlet velocity of approximately $7.5 \frac{m}{s}$. According to Haas-Meincke the inlet air velocity is approximately $12 \frac{m}{s}$, as stated in Section 5.2.2. Therefore the pitot tube with the plastic tube was chosen as the velocity measurement system for the comparison work. For the comparison the average inlet velocities were measured in 16 nozzles both in the batch oven (1 repetition) and in the tunnel oven (2 repetition). Each measurement is found as the average value obtained over 10 seconds with a sample rate of $1 s^{-1}$.

6.3.1 Results of comparative experiments

The air velocities measured in the tunnel oven are shown in Table 6.3 along with measurements from the setting providing the closest match in the batch oven. A two-side student's t-test showed no significant difference between the mean values for either top or bottom air ducts ($p = 0.12$).

Table 6.3: *The air velocities (m/s) with ovens set to a 50:50 distribution between top and bottom inlet air ducts, standard deviations are given after the average values. Number of measurements: $n = 32$ in the tunnel oven and $n = 16$ in the batch oven.*

	Tunnel oven (m/s)	Batch oven (m/s)
Inlet area	Average	Average
Top	7.1 (0.7)	6.8 (0.2)
Bottom	7.8 (0.5)	8.0 (0.2)

Based on the used quality parameters good reproducibility was seen (Tables 6.4 and 6.5, rows for $T = 170^{\circ}C$). Even with the evident differences between a batch and a tunnel oven, the baking process is reproducible in the new oven.

The average measured L^* -values on cookies from the tunnel oven was 65 (standard deviation 3.2), and the average value in the batch oven 69 (standard deviation 2.8). Only pictures of 5 or 6 cookies were possible to use for the objective analysis from each oven, therefore further statistical analysis is not performed. For the visual analysis all cookies were evaluated as belonging in the second of the six browning categories (Figure 6.1).

The average water loss was found as the total mass loss per cookie due to slight variations in the cookie height (± 0.5 mm). 5 cookies were measured for the tunnel oven, 6 for the

batch oven (Tables 6.4 and 6.5), the average values were found to be 1.2 g/cookie in the tunnel oven and 1.3 g/cookie in the batch oven.

Comparison when varying the oven settings

Using the air speed, inlet air distribution and baking time of 8 min from the previous experiments the effects of changing the temperature on the product quality was tested both in the batch oven and the tunnel oven. The additionally tested temperatures were: 160°C, 190°C and 200°C. The product and quality parameters were the same as in the initial experiments. The color ranking and the L*-values are shown in Table 6.4, and the weight loss data in Table 6.5, both including the results from the initial comparison experiments.

Table 6.4: Data for validation experiment, comparing the batch oven with the tunnel oven, standard deviations are shown after average values. The color categories are shown for all cookies. $n = 5$ cookies for the tunnel oven or and $n = 6$ cookies for the batch oven.

Temperature (°C)	Color evaluation categories		Lightness (average L* values)	
	Tunnel	Batch	Tunnel	Batch
160	1, 1, 1, 1, 1	2, 1, 2, 1, 1, 1	65 (5.2)	72 (1.5)
170*	2, 2, 2, 2, 2	2, 2, 2, 2, 2, 2	65 (3.2)	69 (2.8)
190	4, 4, 4, 4, 4	4, 4, 4, 4, 3, 4	54 (4.2)	53 (5.7)**
200	5, 5, 5, 5, 5	5, 5, 5, 5, 6, 5	41 (5.7)	45 (4.6)

*Results from the initial comparison experiments. ** Only 5 of the 6 cookies were available for this measurement.

Table 6.5: The weight loss for each cookie (g/cookie) is shown followed by the average value.

Temperature (y)	Weight loss (g/cookie)	
	Tunnel	Batch
160	1.2, 1.2, 1.2, 1.1, 1.1 (1.2)	1.2, 1.2, 1.2, 1.2, 1.2, 1.2 (1.2)
170*	1.2, 1.2, 1.2, 1.3, 1.2 (1.2)	1.3, 1.3, 1.3, 1.2, 1.2, 1.3 (1.3)
190	1.4, 1.4, 1.4, 1.4, 1.3 (1.4)	1.3, 1.5, 1.5, 1.4, 1.3, 1.4 (1.4)
200	1.5, 1.5, 1.5, 1.5, 1.5 (1.5)	1.3, 1.5, 1.2, 1.6, 1.5, 1.5 (1.4)

*Results from the initial comparison experiments.

Considering the L*-values the cookies baked in the batch oven appear slightly lighter than those from the tunnel oven. The ranking indicates that the overall impression of the cookies was the opposite. This small contradiction might be a result of the L*-value measuring points, not including the outer rims of the cookies which will brown first. This hypothesis will also explain why cookies baked in the tunnel oven at 160°C were all evaluated as category 1 cookies and all baked at 170 °C as group 2, despite the

similar average L^* values. The weight loss data (Table 6.5) show little differences between the treatments. For both ovens a clear trend of increasing weight loss with increasing temperatures is observed.

The overall quality changes when varying the air temperature were similar in the two ovens. However, the quality parameters further indicate that work is needed to enhance the uniformity of baking across the baking tray in the batch oven at higher temperatures. The small contradictions between L^* -values and browning categories call for a better evaluation method of the global browning impression of cookies, possibly an integration of L^* -values at the upper surface could be used. It would be interesting to apply the VideometerLab method described in Section 4.3 to obtain overall browning scores for the cookie surfaces.

6.4 Influence of inlet air velocity on butter cookies quality

The study presented in this section is a description of the first work utilizing the ability of the batch oven to work outside normal process settings. In the previous sections it is described how the temperature is varied and the results are compared to those obtained in a tunnel oven. In this section the inlet air velocity is the variable parameter. Due to the design of a traditional tunnel oven with only one air velocity setting, the results obtained in this work cannot be validated against the available tunnel oven. The measurable effect when changing between five inlet air velocity settings are investigated. The center setting was adjusted to match the tunnel oven, as described in Chapter 6. The scope of this part of the validation work was to ensure that the option to vary the inlet air velocity is sufficiently pronounced to result in a measurable variation in product quality.

6.4.1 Experimental work

Butter cookies, as described in Section 6.2.2 were used in the experimental work. After baking the lightness was measured in three positions on the cookie surface using a CR-200 colorimeter, Minolta (Japan). The weight loss was measured after baking with a LE6202s scale (resolution of 0.01 g), Sartorius (Germany). The weight loss is presented as the final mass fraction, found by dividing the final product weight with the initial weight. Two experimental series were carried out:

1. Cookies were baked at five different air velocity settings (1, 3, 5, 7, 9), all for 8 min at 180°C. Three batches of six cookies were baked at each setting.
2. Cookies were baked at three different air velocity settings (3, 5, 7) at different baking times (2 - 14 min with 2 min intervals), all at 180 °C. One batch of six cookies was baked at each combination of baking time and inlet air setting.

The first series of experiments was used to investigate the quality influence of the inlet air velocity at a constant, reasonable baking time. The purpose of the second series was to investigate the influence of the inlet air flow on the progress of the baking process.

Due to the complex flow pattern (Section 6.3) and the available measurement methods the air velocity was not quantitatively measured in this study.

6.4.2 Results and discussion

Constant baking time

The final mass fraction and the lightness as L^* -values after 8 min of baking at different inlet air settings are shown in Tables 6.6 and 6.7 along with the relative standard deviation¹. 18 measurements were obtained at each inlet air velocity. The results were evaluated through a one-way ANOVA test. The mass fraction data and average L^* -values for the 18 measurements are shown in Appendix I along with the ANOVA test schemes. Significant difference on a 95% level was found between the inlet air setting groups for both quality aspects.

Table 6.6: The final mass fractions for the first series of experiments are shown with standard deviation and the relative error. All cookies were baked for 8 min. $n=18$ at each inlet air setting.

Velocity setting	Final mass fraction	Relative standard deviation (%)
1	0.8729	1.9
3	0.8672	1.5
5	0.8658	3.4
7	0.8627	1.4
9	0.8610	1.5

Table 6.7: The average lightness as L^* for the first series of experiments are shown with the standard deviation and the relative error. All cookies were baked for 8 min. $n=18$ at each inlet air setting.

Velocity setting	Lightness (L^*)	Relative standard deviation (%)
1	79	0.7
3	77	1.3
5	76	1.7
7	75	1.7
9	73	2.3

When increasing the air velocity a systematic increase in evaporation was seen after 8 min of baking. The total dry matter content in the cookies was measured to approximately 86%, showing that the cookies are almost entirely dried after the 8 min baking time at the

¹Relative standard deviation = standard deviation / measured average · 100 %

highest air velocity. The browning, estimated by lightness measurements, shows a similar development. When increasing the air velocity the lightness is decreasing. It is seen that at a fixed baking time the oven is capable of producing air flow conditions resulting in significantly different products.

Varying velocity and baking time

The results from the second series of experiments are shown graphically in Figure 6.5. The lightness could not be measured after a baking time of only 2 min. At this short baking time, the cookies are completely soft, and few maintained a cookie shape with even measurable surfaces when transferred from the oven to the scale.

Introductory experiments and literature studies show that the lightness of cookies will increase during the development phase (Broyart et al., 1998). When the drying is initiated the lightness begins to decrease. Figure 6.5(a) show that a threshold must be crossed before the browning process starts. From the results this point is found between 6 and 8 min of baking for the investigated processes.

Following the experiments with constant baking time, it was not surprising that the highest air velocity resulted in the fastest browning and product drying. The measurements show that systematic differences are seen through the main part of the baking processes. When the baking time approaches 14 min the differences are decreasing. The final mass fraction is almost the same for all three groups of products.

The mass flux, calculated as the difference in evaporated water between two measuring points ($(g_{water}/g_{initialweight}) \cdot s^{-1}$), is shown in Figure 6.5(c). The initial evaporation rate is highest at the highest air velocity. After the peak rates around 200 s the evaporation rate decreases fastest for the highest air velocity. After 480 s of baking the evaporation rates decrease to similar values for all three air settings. This indicates that evaporation of the free water is completed and the slower drying of harder bound water is initiated.

It is seen that the water evaporates freely in the beginning of the baking process, where after the evaporation rates decrease as the surface dries out and stronger bound water is evaporated by diffusion drying. The evaporation was seen to follow the air velocity. With a high air velocity the initial evaporation rate is fast. This results in a fast drying of the product surface, followed by a slower evaporation rate as the stronger bound water begins to evaporate. Over-all this pattern was as expected, and it is a success criterion for the versatility of the batch oven, that it is possible to obtain this pattern.

6.5 Summary of validation

The experimental results show that the new batch oven is promising for research in varying process conditions. Considering the inlet air velocity and the heat transfer coefficient

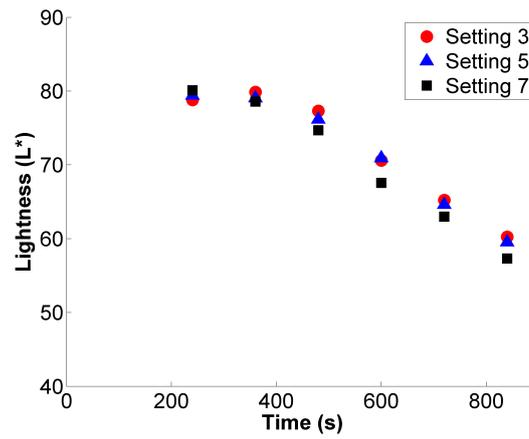

(a) Average surface lightness

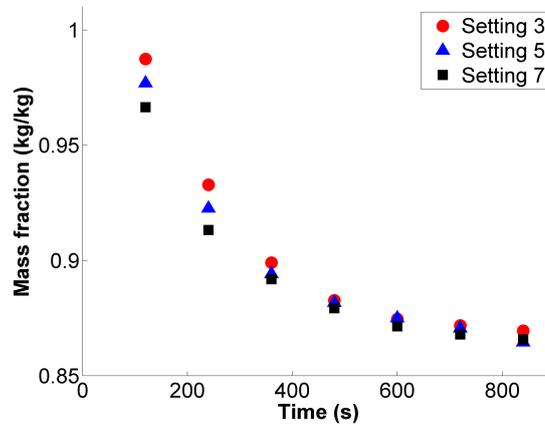

(b) Average mass fractions

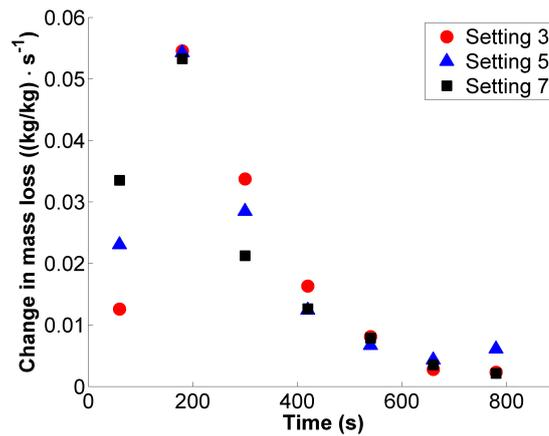

(c) Change in mass loss

Figure 6.5: (a) Average cookie lightness as a function of baking time at three different inlet air velocities. (b) Average cookie mass loss (calculated as the mass fraction) as a function of baking time at three different inlet air velocities. (c) The change in mass loss as a function of time ($\Delta m(g/g)/\Delta t$).

measurements, low variation was seen across the baking area. An improved estimate of either the inlet air velocity or the velocity near the product should be further investigated. The variation in the heat transfer coefficients across the baking tray is small and random.

Comparison experiments show that it is possible to bake butter cookies of comparable quality in the batch oven and a tunnel oven. In the future more repetitions could be beneficial to improve this validation process. Also more than one product group should be examined.

The final validation step was an experimental investigation of the ability of the oven to create significantly different baking conditions through the build-in options for process variation. Besides the basic ability to vary air temperature the option of varying the inlet air velocity is the most prominent feature in the oven. Therefore this was chosen for the first validation experiments. The experimental work showed significant dependency between changes in the inlet air flow setting and the mass loss and surface browning. The progress of both browning and drying was found to differ when the inlet air settings were varied.

The oven shows promising potential in regard to investigating baking processes outside the normal range of tunnel ovens. Additional features are available and will increase the prospects of the oven in the future.

Chapter 7

Mathematical-physical models and model parameters

The work described in Chapters 7,8, and 9 is an elaboration of the work presented in the manuscript "Investigation of uneven mass transfer in butter cookies combining experimental work and finite element modeling" (Appendix F), submitted for publication in the International Journal of Food Engineering, June 2013.

7.1 Heat and mass transfer

One goal of the new batch oven is to help in the development of mathematical models describing the relations between baking process conditions and baking product quality. The scope is to use experimental data from the batch oven to predict the outcome in full scale industrial tunnel ovens.

This and the following chapters focus on formulating and solving mathematical models to calculate the heat and mass transfer in bakery products during baking. The results obtained from the models are compared to and optimized against experimental data from the new batch oven.

In the present work the focus is on biscuit baking, specifically on a butter cookie product. The main focus for modeling of bakery products has traditionally been on leavened bread products, but relevant work is also reported considering biscuit products. A general review of modeling work, covering different bakery products, is presented in Section 2.3. Some examples of modeling work focusing on heat and mass transfer in continuous baking of biscuits, focusing on the oven conditions are presented by Savoye et al. (1992) and Broyart and Trystram (2002). Studies of the governing mechanisms and properties related to mass transfer in biscuit products is presented by Demirkol et al. (2006b) and McFarlane (2006).

Some of the background knowledge and model parameter comparison is obtained in relation to studies of bread baking and roasting or frying of meat. The latter due to the similar physical process, geometry, and basic physical mechanisms.

7.1.1 Heat transfer

Energy transfer from the surroundings to the product and from the surface to the inside of the product are the two main aspects of energy movement in the baking of biscuits. The heating of the product causes physio-chemical changes in the dough and dries the product by evaporation of water.

The heat transfer through the product is described as conduction, following Fourier's law. The temperature difference between the heated surface and the colder center is considered as the driving force for energy transport through the system. This description for heat transfer is generally used in modeling of thermal treatment of food products (Purlis, 2010; Wählby, 2002; Demirkol et al., 2006b; Mondal and Datta, 2008; Sablani et al., 1998; Sakin-Yilmazer et al., 2012; Thorvaldsson and Janestad, 1999; Chen, 1999; Feyissa et al., 2011).

The geometry of the cookie product is considered a finite cylinder. Thus the Fourier equation for a two dimensional cylindrical coordinate system is used to describe the energy transfer inside the biscuits as shown in (7.1) (Bird et al., 2002).

$$\rho c_p \frac{\partial T}{\partial t} = k_T \left(\frac{1}{r} \frac{\partial}{\partial r} \left(r \frac{\partial T}{\partial r} \right) + \frac{\partial^2 T}{\partial z^2} \right) \quad (7.1)$$

where ρ is the density of the product $\left[\frac{kg}{m^3} \right]$, c_p the specific heat capacity $\left[\frac{J}{kgK} \right]$, T the temperature $[K]$, t the time $[s]$, k_T the thermal conductivity $\left[\frac{W}{mK} \right]$, r the radial direction $[m]$, z the axial direction $[m]$. The nomenclature is also given in Table 7.1 for the equations and boundary conditions.

The initial conditions are as follows in (7.2), specifying that the temperature throughout the product is uniform when baking is initiated.

$$T(r, z)|_{t=0} = T_0 \quad (7.2)$$

While the internal heat transfer may be generally described as heat conduction, the energy transfer from the surroundings to the product depends on the process conditions. Heat transfer from the surroundings to the product is generally described by one or more of the following: conduction, radiation, and convection.

Conduction is the dominating source of energy transfer in the case of contact baking (Feyissa et al., 2011; Sterner et al., 2002) where the energy is transferred to the product by direct contact between surfaces. Radiation is the transfer of energy from one surface

to another with no direct contact and no carrying medium besides the electromagnetic radiation. Radiative heating depends on the temperature and color of both surfaces. In baking processes typical simplifications are to assume that the oven walls emit black body radiation and the emissivity of the product has a constant value; for example 0.9 for bread products (Purlis, 2010; Thorvaldsson and Janestad, 1999). Convection heating is heat transfer by a moving medium such as air or water, and is either free or forced in nature. In the case of “pure” radiation heating, changes in the air density will result in air movement creating an added heat transfer by free convection. Free convection results in a heat transfer coefficient in the range of 5 - 25 ($\frac{W}{m^2K}$) depending on the specific process (Singh and Heldman, 2009). Increasing the air speed by the use of fans or ventilation systems results in forced convection. Due to the increased air velocity forced convection will lead to higher heat transfer coefficients compared to free convection (cf. Nusselt’s relations in Section 6.2.1). The heat transfer coefficient for forced convection is approximately in the range of 10 - 200 ($\frac{W}{m^2K}$) for food production processes (Singh and Heldman, 2009).

The investigated baking process is based on indirectly fired convection tunnel ovens. In this oven the hot air enters the oven chamber above and below the baking band and creates a forced convection environment. The oven type is further described in Section 2.1.

Besides forced convection heating, some degree of radiation and conduction heat transfer will take place in the oven. However, in the present modeling work the contribution from radiation or conduction is not included. Future measurements of the relation between heat flux from radiation and convection heating should be considered, for example using a data logger system such as Scorpion[®], Reading Thermal, United Kingdom ¹ which is available with assistance from Haas-Meincke A/S.

Water evaporates during baking. The energy consumption for evaporation is included in the present model through the equations describing the boundary conditions. The energy available for product heating is the total energy transferred to the product minus the energy needed for water evaporation. Different ways to include the evaporation in the model are discussed in Section 2.3. In this work the evaporation is solely included at the surface boundaries and not in the diffusion equation (Chen, 1999; Ferrari et al., 2012; Feyissa, 2011; Mondal and Datta, 2010; Olszewski, 2006; Purlis, 2012). The boundary conditions are given in (7.3).

$$k_T \left. \frac{\partial T}{\partial \bar{n}} \right|_{surface} = \begin{cases} h_T (T_a - T) & , \\ h_T (T_a - T) + \Delta H_{vap} \rho D \left. \frac{\partial x_w}{\partial \bar{n}} \right|_{surface} & , \end{cases} \quad \begin{matrix} T < T_{vap,w} \\ T \geq T_{vap,w} \end{matrix} \quad (7.3)$$

where \bar{n} is the direction normal to the surface [m], h_T the heat transfer coefficient [$\frac{W}{m^2K}$], T_a the air temperature [K], $T_{vap,w}$ the initiation temperature for water evaporation [K], ΔH_{vap} the enthalpy of evaporation for water [$\frac{J}{kg_{water}}$], ρ density of the product [$\frac{kg}{m^3}$], D the diffusion coefficient [$\frac{m^2}{s}$], x_w the water content [$\frac{kg_{water}}{kg_{product}}$].

¹<http://www.readingthermal.com/scorp-data.html>

In related studies the density of the water or an unspecified density is included in the evaporation term (Mondal and Datta, 2008; Thorvaldsson and Janestad, 1999). In the present study the density of the product is used ensuring correct units and dimensions.

The left-hand side accounts for the energy being transported into the bakery product. The terms on the right-hand side is the heat transfer to the product by convection and then the energy needed to evaporate water. The latter is found by applying the mass transfer mechanism of diffusion, as described in Section 7.1.2. It is important to notice that the applied heat and the mass transfer boundary conditions are not directly codependent. The temperature boundary conditions depend on results from the mass transfer equations, while the opposite is not the case. The limiting factor for the mass transfer boundary condition is a fixed, predefined temperature. When this temperature is exceeded the evaporation term is included, and evaporation is set to a constant rate. The constant rate is an average of the total mass loss during baking calculated from, and optimized against, experimental data. This is further described in Section 7.2.2 (cf. (7.12) and (7.13)).

In the presented model the energy transfer through the product is assumed to take place by conduction. For a dense material this is generally an adequate description of the energy transport. It should be noted that the investigated cookies are increasingly porous products. While the porosity is not included as a factor in the following modeling of the heat and mass transfer it will influence the experimental data. Two main effects might be seen from the porosity in relation to the energy transfer. In the first phase of baking air bubbles incorporated in the cookie dough may result in a lower actual thermal conductivity than the theoretically calculated value. When the temperature is sufficiently high for water to evaporate, larger bubbles are formed in the product. In these bubbles Watts principle will increase the heat transfer (Thorvaldsson and Skjoldebrand, 1998). In the final stages of baking the water may evaporate faster than anticipated from the model due to evaporation inside the product and rapid diffusion through the continuous porous network of the cookie.

7.1.2 Mass transfer

In biscuit products mass transfer will take place both through the product and from the surface to the surroundings in form of evaporation during baking. The main product being transferred is water, either as liquid water or water vapor. Additionally a small amount of CO_2 will be formed from the NaHCO_3 . While this will result in some expansion and a small contribution to the overall mass transfer it is not included in this study.

In larger bread products, where the final product consists of a soft crumb center and hard outer crust, water transport has been observed both towards the product center and away from the product by evaporation (Thorvaldsson and Skjoldebrand, 1998). The transfer towards the center is a result of the temperature difference between the heated outer surface and the colder interior of the product. The inwards transport is due to Watt's principle and the evaporation due to surface heating (Thorvaldsson and Skjoldebrand,

1998; Hadiyanto et al., 2007).

Thin biscuit products are comparable to bread crust for the purpose of heat and mass transfer. During baking of biscuits there is some resemblance to the development in bread products. The mechanisms include moisture transport towards the center, followed by formation of a continuous network. However the variation through the product is estimated to be much smaller in biscuit products compared to bread products, and with the available measuring equipment it has only been possible to measure the overall water content in the investigated products.

The water transport is modeled as a diffusion process. Similarly to other studies of biscuit products the model is simplified by combining the water transport into an average mass transfer, combining the transport of liquid water and water vapor (Broyart and Trystram, 2002; Demirkol et al., 2006b; Ferrari et al., 2012). The diffusion and the mass transfer coefficients are therefore considered apparent values. These are based on the total mass transfer and should not be linked solely to either liquid water or water vapor transport. However, considering the porous structure of the final product the values for the apparent coefficients are expected to be closest to values for vapor transfer.

Based on the concentration gradient created by the evaporation at the surface the moisture concentration through the product is determined by diffusion and a concentration gradient following Fick's second law (Bird et al., 2002). For mass transfer in the height and radial directions the equation for diffusion is given in (7.4).

$$\frac{\partial x_w}{\partial t} = D \left(\frac{1}{r} \frac{\partial}{\partial r} \left(r \frac{\partial x_w}{\partial r} \right) + \frac{\partial^2 x_w}{\partial z^2} \right) \quad (7.4)$$

With the initial conditions given in (7.5).

$$x_w(r, z)|_{t=0} = x_{w0} \quad (7.5)$$

where x_{w0} is the initial water content $\left[\frac{kg_{water}}{kg_{product}} \right]$.

The boundary conditions at the surfaces describe the evaporation process. While a small degree of evaporation will take place from the initiation of baking, due to the high temperature and low relative humidity in the oven, the main evaporation begins when the surface reaches a temperature close to 100°C. A more precise temperature is determined from experimental work, measuring a combination of temperature and mass loss during baking. In the present work the temperature at which a plateau in the temperature increase is found, is used as the evaporation initiation temperature.

Following there are two possible situations for the mass transfer as described by this model, either no evaporation from the surface or evaporation depending on the surface moisture concentration gradient, and a constant mass transfer coefficient (7.6).

$$D \frac{\partial x_w}{\partial \bar{n}} = \begin{cases} 0, & T < T_{vap,w} \\ k_c (x_{w,a} - x_w), & T \geq T_{vap,w} \end{cases} \quad (7.6)$$

where k_c the average mass transfer coefficient $\left[\frac{m}{s}\right]$, $x_{w,a}$ is the water fraction in the air $\left[\frac{kg_{water}}{kg_{air}}\right]$, and $T_{vap,w}$ the initiation temperature for water evaporation $[K]$.

The use of a constant mass transfer coefficient is discussed in Demirkol et al. (2006b) along with a water content dependent mass transfer coefficient. An average mass transfer coefficient is found as the integrated mass loss over the baking time divided with the total baking time (Demirkol et al., 2006b) (cf. Section 7.2.2). As the mass loss is not linear through the baking process changes in baking time will change the average mass transfer coefficient. In the present work a constant average mass transfer coefficient is applied in order to simplify the model. The initial mass transfer coefficient is calculated from the total evaporation in a 14 min baking process, based on (7.13) (Demirkol et al., 2006b). The experimental work and calculations are described in Section 7.2.2.

7.2 Parameters for the simulations

Before the presented model can be solved a number of parameters are required. In the following the parameters are divided into three groups. The first group (Section 7.2.1) includes the parameters related to the product's physical properties. Besides the product composition these are density, specific heat capacity, and the thermal conductivity. The second group (Section 7.2.2) concerns the evaporation of water. This groups includes the diffusion and mass transfer coefficients. The mass transfer coefficient is dependent on both the product composition and the process conditions. In this work it is found as an average value from experimental work, this is described in more details in Section 7.2.2. The third group (Section 7.2.3) are parameters describing the process. This group primarily includes the oven temperature and the heat transfer coefficient.

During baking the temperature and the water content change affecting the product properties. The applied models for the three groups of parameters are described in the following.

7.2.1 Product properties

Initially the cookie dough is compact and semi-solid. During baking the dough is transformed to a porous brittle structure. It is evident that the real physical properties of the final product will differ from the properties of the dough, and change depending on the water content, the temperature, and structure of the solid product matrix. The estimated physical properties are changing according to the water content of the cookies. They are calculated using the equations described in the following. Changes in porosity and volume are not included in the present model.

Table 7.1: Symbols and subscripts used in the heat and mass transfer equations. Where relevant the origin of the value is indicated.

Symbol	Description	Unit	Origin
T	Temperature	K	Measured or calculated
x	Mass fraction	$\frac{kg}{kg}$	Measured or calculated
t	Time	s	
r	Radial distance[0;R]	m	
z	Height distance	m	
\bar{n}	Direction normal to the surface	m	
Thermal properties			
ρ	Density	$\frac{kg}{m^3}$	Measured
c_p	Specific heat capacity	$\frac{J}{kgK}$	Calculated (Choi and Okos, 1986)
k_T	Thermal conductivity	$\frac{W}{mK}$	Calculated (Choi and Okos, 1986)
h_T	Heat transfer coefficient	$\frac{W}{m^2K}$	Calculated (Choi and Okos, 1986)
Mass transfer properties			
k_c	Mass transfer coefficient	$\frac{m}{s}$	(Demirkol et al., 2006b) and calculations
D	Diffusion coefficient	$\frac{m^2}{s}$	(Demirkol et al., 2006b) and calculations
ΔH_{vap}	Enthalpy of evaporation (water)	$\frac{J}{kg}$	(Chen, 1999)
Subscripts			
0	Initial value		
a	Air		
vap	Evaporation		
w	Water		

When solving the model the volume of the product is kept constant. Measurements on images in Section 4.3 showed an average diameter of approximately 4.7 cm. The deviation in radius is thus small, less than 5%.

In the following the applied values and equations for the product properties are described. In equations based on the composition of the product the word "component" refers to constituents such as protein, carbohydrates, fat, water, and ash.

The density

The density is calculated as the time dependent product weight divided by the initial product volume. It is assumed that the volume remains constant throughout the baking process. In preliminary investigations the density equation given by Choi and Okos (1986) was applied. However, it was found that this method did not yield a realistic prediction of

the actual change in the product density. This is likely because the method suggested by Choi and Okos is purely related to the composition of the product, and does not include the increasing porosity of the cookie as water evaporates while the volume is increasing or unchanged. For this reason the approach was changed to a more direct method: The initial dough density was found from the average weight of 90 cookies, this weight was divided by the initial volume of the cookies (diameter = 45 mm, height = 6 mm). In the simulations the time dependent density is found as the initial weight minus the evaporated water divided by the volume. The resulting equation is given in (7.7).

$$\rho_{cookie} = \frac{m_{dough} - m_{w,evap}}{V} \quad (7.7)$$

where m is the initial dough-cookie weight, V the volume, $m_{m,evap}$ the mass of evaporated water.

The average dough density was 1299 kg/m^3 and the initial water content 1.74 g/cookie , determined by dry matter measurements on the cookie dough.

The specific heat capacity

Following the work presented by Choi and Okos (1986) the specific heat capacity may be calculated from (7.8) as a function of the water concentration.

$$c_p = \sum x_i^w c_{p,i} \quad (7.8)$$

where the x_i^w is the mass fraction of the i^{th} component and $c_{p,i}$ is the specific heat capacity of the i^{th} component. Based on the cookie dough composition (7.9) was applied as a variable in the simulation work, x_w is the water mass fraction in the cookie. The “i’th” components are generally protein, fat, carbohydrate, water, and ash. Inserting all but the water content in (7.8) the following expression for c_p is obtained, (7.9), for the butter cookies.

$$c_p = 1.5 \frac{\text{kJ}}{\text{kgK}} + x_w \cdot 4.2 \frac{\text{kJ}}{\text{kgK}} \quad (7.9)$$

The thermal conductivity

Based on the product composition and the equations presented by Choi and Okos (1986) the thermal conductivity is calculated from (7.10).

$$k_T = \sum x_i^V k_i \quad (7.10)$$

x_i^V is the volume fraction and k_i the thermal conductivity of the i^{th} component. Values based on the dough composition, maintaining a constant cookie volume (7.11), are obtained for the investigated product. These are used in the simulations to calculate k_T as a function of water concentration. In (7.11) the applied expression for k_T is shown.

$$k_T = 0.21 \frac{W}{mK} + 0.62 \frac{W}{mK} \cdot \frac{x_w}{6.69 \cdot 10^{-4} \cdot \rho_w + x_w} \quad (7.11)$$

where ρ_w is the density of water.

7.2.2 Water transport and evaporation

The governing parameters for water transport is the diffusion and mass transfer coefficients. Water transport and evaporation dependent on a number of product and process conditions. For example the surface temperature, the relative air humidity, the air velocity at the product, the product porosity, and moisture concentration in the product. Considering (7.6) not all of these factors are included. Instead the diffusion and mass transfer coefficients represent some of these aspects of the process. Initial values are estimated for the two coefficients. To incorporate the many aspects of the coefficients the initial estimates are optimized to obtain apparent coefficients. This is further described in Section 7.2.2.

The diffusion coefficient

In the present work an average apparent diffusion coefficient is applied. A time-dependent diffusion coefficient would increase over time even if the porosity is not explicitly included in the model. In the present model there will be a risk of the diffusion coefficient overestimating the diffusion in the beginning of the baking process.

Water on liquid and gaseous form is transported through the product during baking. For bread products it has been shown that water is both transported towards the center due to the temperature gradient and towards the outer surface due to the concentration gradient arising from evaporation (Hadiyanto et al., 2007; Thorvaldsson and Skjoldebrand, 1998). While different mechanisms are responsible for these opposite transport phenomena, and the liquid and gaseous water is transported at different rates, an average apparent diffusion coefficient is applied in the present work.

The initial guess for a value of D is $3.6 \cdot 10^{-8} \frac{m^2}{s}$, which is an empirically found diffusion coefficient obtained for biscuits baked at 190°C with forced convection (Demirkol et al., 2006b). Other works divide the diffusion coefficient between the transport of liquid water and water vapor. For example for bread products (Thorvaldsson and Janestad, 1999) reports the following values $D_{liquid\ water} = 1.35 \cdot 10^{-10} \frac{m^2}{s}$ and $D_{vapor} = 8 \cdot 10^{-7} \frac{m^2}{s}$. For biscuit baking the diffusion coefficient for liquid water does not appear to change, while the diffusion coefficient for water vapor strongly increases (Hadiyanto et al., 2007): $D_{liquid\ water} = 1.1 \cdot 10^{-10} \frac{m^2}{s}$ and $D_{vapor} = 2.10 \cdot 10^{-5} \frac{m^2}{s}$. Generally liquid water diffusion through the solid matrix is slow, while the transport of water vapor through the open structure is considerably faster.

The mass transfer coefficient

Based on the work presented in (Demirkol et al., 2006b) an initial k_c value was found, from the equation given in (7.12).

$$k_c(t) = -\frac{V}{A} \frac{dY(t)}{dt} \frac{1}{Y_0} \quad (7.12)$$

where Y_0 and $Y(t)$ are the initial and time dependent water concentrations (on dry matter basis, ($kg_{water}/kg_{dry\ matter}$)). According to (7.12) k_c can be calculated from the mass loss during baking, the geometry of the product, and the initial water content (on dry matter basis) in the cookie (Demirkol et al., 2006b; Markowski, 1997). In the present work an average k_c value for the baking process was calculated from (7.13).

$$k_{c,av} = \frac{\int_0^t k_c(t) dt}{t} \quad (7.13)$$

The water concentration was found to decrease exponentially following (7.14) when the oven settings were set to mimic the conditions in a 10 m tunnel oven (cf. Chapter 6). The experimental results and graph for the exponential regression are shown in Figure 7.1.

$$Y(t)_{exp} = 0.1628e^{-3.8 \cdot 10^{-3} \cdot t} \quad (7.14)$$

From (7.13) and (7.14) $k_{c,av}$ for a 14 min baking period was $2.7 \cdot 10^{-6}$ m/s. Similar to the diffusion coefficient this literature based value was used as an initial guess in the simulation work, where optimized values are estimated from comparison to experimental data.

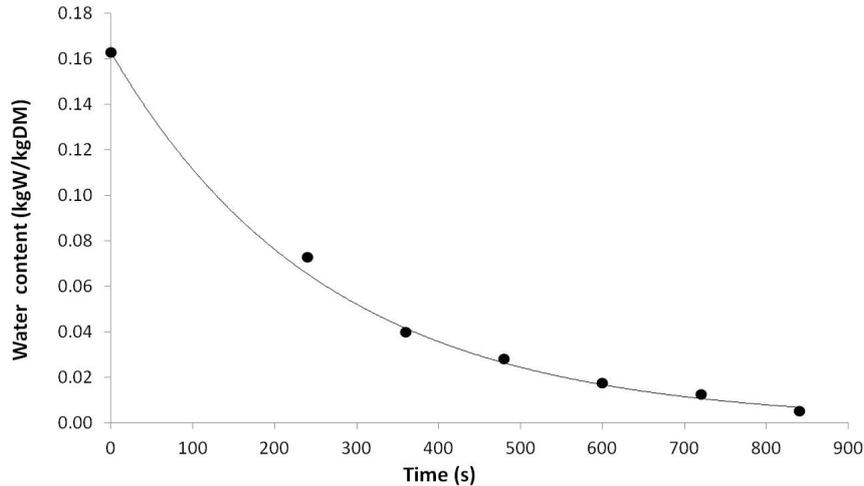

Figure 7.1: • Experimental measuring points. – Regression line for an exponential approximation to the evaporation. Measurements of the water content on dry matter basis to determine the evaporation rate for calculation of k_c .

7.2.3 Process properties

The process properties used to characterize the baking process in this work are the oven temperature and the average heat transfer coefficient at the product. The oven temperature is measured by a thermo sensor a few centimeters above the baking tray, and besides being used for feedback control of the process it is logged continuously during baking.

Heat transfer coefficient

The method and measured values for the heat transfer coefficient are described in Section 6.2.1. The average heat transfer coefficient determined by the use of aluminum cylinders is applied in the modeling work. As stated in the previous section cylinders of the same shape as the cookies were found to heat too quickly for the oven to reach a steady state temperature. Therefore aluminum cylinders with a diameter of 40 mm and a height of 60 mm were used instead.

The characteristic length of the cylinders is the diameter, since the air flow close to the cookies is parallel to the baking tray. The values of the diameters are close to each other, but the larger height of the aluminum cylinders may increase the average heat transfer coefficient compared to the actual heat transfer experienced by the cookies. On the other hand the uneven surface of the cookies will result in an increased local turbulence, and hence higher heat transfer, compared to the smooth aluminum surface. The substitution of the cookie geometry with the aluminum cylinders is considered an acceptable approximation for obtaining a heat transfer coefficient for the modeling work. The air flow settings were similar to those used in the baking experiments for validation. The applied average heat transfer coefficient is $63 \frac{W}{m^2K}$.

Chapter 8

Numerical solution of heat and mass transfer equations

The work described in Chapters 7,8, and 9 is an elaboration of the work presented in the manuscript "Investigation of uneven mass transfer in butter cookies combining experimental work and finite element modeling" (Appendix F), submitted for publication in the International Journal of Food Engineering, June 2013.

This chapter explains how the equations from Chapter 7 are solved numerically by the use of a finite element method. The model is improved and validated by comparison to experimentally obtained data from the pilot oven.

8.1 Numerical solution methods

For differential equations analytical solutions give the most accurate results. However, analytical solutions are not always the most efficient way to solve more complex systems of differential equations or may not be available at all (Martins et al., 2008). In such cases numerical solutions are applied. Numerical solutions are obtained by discretization of the differential equations to systems of difference equations, which are solved for a number of points and summed (Tijssens et al., 2001). The change from an analytical to a numerical approach also changes the solution from exact to approximate.

Different numerical methods are used to solve differential equations in the fields of food science and technology such as the finite difference methods (FDM), finite volume method (FVM), and finite element method (FEM)(Martins et al., 2008; Tijssens et al., 2001). The oldest of these discretization methods is the FDM, described by Euler as early as 1768 (Tijssens et al., 2001). Following this method the investigated geometry is divided into a number of evenly spaced and sized cells, for each cell the derivatives in the governing equation are approximated by differences over a length equal to the size of the cell. If the

size of the cells is decreased the accuracy of the approximation increases. As an example the governing second order differential equation for heat transfer (Equation (7.1)) is shown in (8.1) applying the backward Euler method and central difference formula (Tijskens et al., 2001).

$$\frac{\partial T_{i,j}}{\partial t} = \Delta t \frac{k_T}{\rho c_p} \left(\frac{1}{r_i} \frac{T_{i,j} - T_{i-1,j}}{r_i - r_{i-1}} + \frac{T_{i+1,j} - 2T_{i,j} + T_{i-1,j}}{(r_i - r_{i-1})^2} + \frac{T_{i,j+1} - 2T_{i,j} + T_{i,j-1}}{(z_i - z_{i-1})^2} \right) \quad (8.1)$$

Where $\Delta t = (t_i - t_{i-1})$, $\Delta r = (r_i - r_{i-1})$ and $\Delta z = (z_i - z_{i-1})$. FDM is a good and low cost method with regard to computational demands, however it is not suited for simulations of complex food products or complex geometries (Wang and Sun, 2003).

With the FVM the geometry is divided into cells consisting of smaller volumes. Each volume has constant physical and chemical properties. The value of one volume affects the value in the next volume (Jensen et al., 2003). For example energy flux leaving one volume is equal to the flux entering the following volume, thus conserving the total energy in the system. The finite volume method is widely used in computational fluid dynamics programs (e.g. Fluent and Star-CD), mainly because the solvers have traditionally been more suited for turbulence modeling than FEM. FEM is applied in the present work and described in the following Section 8.1.1.

8.1.1 Finite element method

For FEM the investigated geometry is divided into a finite number of small elements. These elements are connected by node points. In each element the governing equation is approximated by a low order polynomial. The overall solution is thus found by combining all the unique solutions at the node points (Tijskens et al., 2001). Different methods can be used to determine the low order polynomials mainly divided into two groups, either the variational method or methods of weighted residuals (such as Galerkin's method or equidistant collocation) (Tijskens et al., 2001; Villadsen and Michelsen, 1978), more thorough descriptions of such methods can be found in the literature and falls outside the scope of this thesis (Martins et al., 2008; Villadsen and Michelsen, 1978).

8.2 Present approach

In the present work the commercially available FEM solver COMSOL Multiphysics 4.3 (COMSOL, 2012) (hereafter simply referred to as COMSOL) is used. The solver applied in COMSOL for the present study is a multifrontal massively parallel sparse direct solver (MUMPS). The application of COMSOL for numerical solving of heat and mass transfer processes have been successfully applied in other studies for different food products. A

few examples: contact baking (Feyissa, 2011), bread baking (Mondal and Datta, 2010; Ploteau et al., 2012; Purlis, 2012), chicken patties (Chen, 1999), and other bakery products such as biscuits and cakes (Ferrari et al., 2012; Hadiyanto et al., 2007). An overview of the main steps for FEM simulation with COMSOL is shown in Box 8.1 (adapted from (Feyissa, 2011)).

Box 8.1: *The main steps for COMSOL modeling (Feyissa, 2011).*

Step 1 - Geometry: The first step is to build the geometry for the simulation, this includes the type of geometry (dimension) and simplification by utilization of relevant symmetries.

Step 2 - Meshing: The geometry is divided into node points forming a mesh. The shape and size of the mesh elements are important for the accuracy of the simulation and the total simulation time.

Step 3 - The model: Relevant physical models are selected (e.g. heat transfer, mass transfer, chemical reactions). The initial and boundary conditions are given along with material properties, parameters and when needed user specified functions.

Step 4 - Solving the model: When all information is filled into the program the models are solved either as stationary or time dependent problems.

Step 5 - Post processing: After solving the models the results can be exported to further processing or directly visualized as plots or used to calculate average properties or other output values of interest.

Step 6 - Validation: A numerical solution should never stand alone. When the simulations are carried out it is important to validate whether the obtained results are actually realistic outside the computer environment.

The investigated cookies are modeled as cylinders of 6 mm in height and 45 mm in diameter. This geometry can be represented in COMSOL in different ways. The full volume can be implemented in a 3D simulation, the cross-sectional area can be investigated alone, or, as done in this work a combination of these two methods a 2D axis symmetrical design can be used. With this method the geometry is built in cylindrical coordinates and rotated around the z-axis giving a 3D volume. The model is thereby solved for a 2D surface, but the result can be directly obtained for the whole volume. Figure 8.1(a) shows the full geometry when rotated around the z-axis, Figure 8.1(b) shows the half cross-section area after meshing (the mesh is described in Section 8.2.2).

8.2.1 Geometry

In cases where the heat and mass transfer is the same through both the top and bottom surfaces only one quarter of the cross-sectional area is needed (Chen, 1999). While the first part of the present work is based on this assumption, the half cross-sectional area is used. This is done to enable comparison to the following work, investigating the effect of asymmetrical mass transfer boundary conditions. During baking it is likely that the baking tray will reduce the evaporation from the bottom surface and influence on the heat transfer, the limiting effect on the mass transfer is described in Chapter 9.

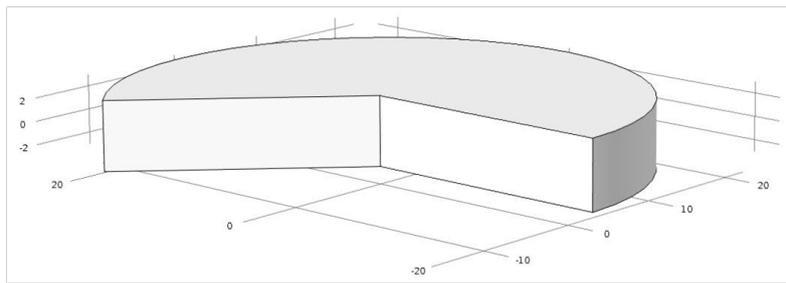

(a) Geometry

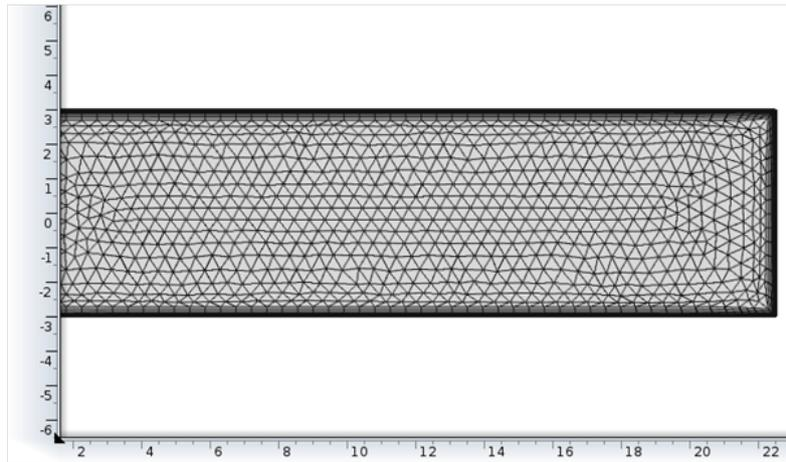

(b) Mesh

Figure 8.1: (a) The full geometry, when rotated around the z -axis. (b) The half cross-sectional area with the applied triangular mesh and 4 rows of boundary layer.

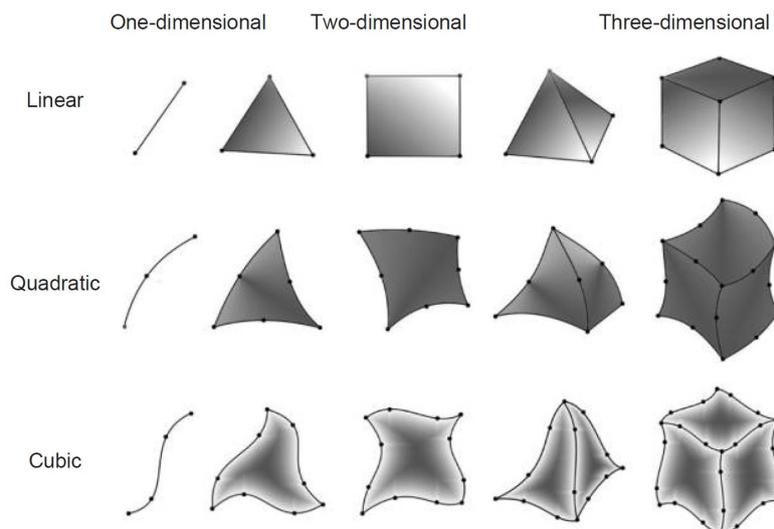

Figure 8.2: Different mesh shapes commonly used in FEM, adapted from (Martins et al., 2008).

8.2.2 Meshing

The mesh is the grid dividing the geometry into finite elements. Different mesh geometries can be used in FEM. The most common are shown in Figure 8.2 for 1D, 2D, and 3D geometries. Depending on the process simulated and the available processing power, different mesh geometries and element sizes are desirable (Martins et al., 2008). Increasing the number of elements in the mesh will increase the accuracy of the solution at the cost of an increased computer processing requirement. In COMSOL linear triangular or quadrilateral elements are available for meshing.

In the present work a 2D mesh consisting of triangular elements was applied. The element size was set using the predefined *extra fine* element size. The resolution of the solution by the outer edges was enhanced through a boundary layer with 4 rows and a growth factor of 1.2. The final number of elements was 2642. To ensure the mesh elements were sufficiently small a test simulation with the predefined element size *extremely fine* (total elements 8482) was performed. In the test simulation the initial k_c and D values were applied for the mass transfer. Comparing the calculated values for the center temperature and the average mass fraction the largest deviation, found for the center temperature at $t = 100$ s, is 0.32 % and the average deviations for the center temperature and mass fraction respectively are: 0.04 % and $2.4 \cdot 10^{-5}$ % covering a 480 s simulation time. With this very small difference in the results the *extra fine* mesh was considered an acceptable resolution for the simulation work. The mesh is shown in Figure 8.1(b).

8.2.3 Water evaporation and temperature

Heat transfer during baking can be separated into steps: initial heating, water evaporation (drying), and if the baking process is continued for sufficiently long time, a final heating step to the oven air temperature. The model in Chapter 7 describes the heating processes with evaporation as a function of the surface temperature.

The mass flux described in (7.6) is restricted by the surface temperature. If the surface temperature is lower than the evaporation temperature the mass transfer coefficient is zero. For computational reasons this is done through a build-in step function in COMSOL. The step function increases from zero to one over a defined temperature interval. From center temperature measurements a plateau, indicating the initiation of evaporation was found close to 105°C. This value is in good concordance to findings described by Mowbray (1981) reporting that a plateau is generally observed around 103°C in biscuit baking. The used step function includes the evaporation gradually in the temperature interval 105-110°C.

8.2.4 Assumptions and simplifications

Models are only approximations to reality. Therefore assumptions and approximations will always be part of modeling work. The important step is to find the balance between simplification by approximations and sufficient complexity to describe reality. The model equations presented in Chapter 7 show one way to represent the reality of baking.

The following assumptions and simplifications were applied when solving the model:

- Heat transfer: An average heat transfer coefficient is used on the entire surface of the product. In the actual baking process the baking tray and local variations in air flow result in varying heat transfer coefficients around the bakery product. These variations are difficult to measure accurately and would furthermore only affect e.g. local water content, while the loss in total water content should be reasonably well characterized by an average heat transfer coefficient. Only convection heating is included in the model. Due to the highly reflective stainless steel surfaces inside the oven and the light color of the product the contribution from radiation is neglected. The low thickness (1.3 mm) of the steel baking tray results in fast heat transfer through the baking tray, and a low transverse conduction rate, this contribution is not included in the heat transfer equations.
- Mass transfer: The water transport is modeled as a diffusion process. To simplify the model only average mass transfer parameters are included, combining the transport of liquid water and water vapor. The diffusion coefficient and the mass transfer coefficient should therefore be considered as apparent coefficients.
- Volume and porosity: During baking CO_2 and water vapor will expand the product volume. Additionally water evaporation and solidification of the cookie matrix will change the structure from dense to porous. In the simulations both the volume and the porosity are kept constant. The lumped effect of the changes in volume and porosity is indirectly included in the solutions since the diffusion and mass transfer coefficients are optimized using experimental data.
- Physical properties: The physical properties are calculated throughout the simulations as functions of the water content; all other ingredient properties and relative contents are kept constant.

In this chapter all effects from the baking tray are ignored. However, it will not only result in a small amount of conduction heating. The baking tray may also limit evaporation from the bottom surface of the product. In Chapter 9 the consequences of this simplification is further investigated.

8.3 Simulation results and validation

An overview of all parameters and variables applied in the COMSOL simulations is shown in Appendix J. From the simulation results two values were extracted. The cookie center temperature and the average mass fraction. The mass fraction is calculated as the final weight divided by the initial weight. The center temperature was found from the build-in function *point evaluation*, giving the desired value in a specific point. The mass fraction was found using the build-in function *volume average* calculating the average of the desired value for the investigated 3D rotation of the investigated domain.

The two values were chosen because they both provide information related to the solved equations, and are possible to validate through experimental data. The mass fraction is a good indicator for the weight loss as it is independent of the initial product weight and thereby robust regarding small variations in the initial cookie weight.

8.3.1 Experiments for validation

Validation of simulation results is extremely important. Though most well presented simulations will look convincing, they might not actually be accurate. In the present work baking of butter cookies is studied. The baking process is possible to monitor as described in Chapter 5. For the validation experiments the product weight and temperature are measured.

The cookie dough is prepared following the recipe in Table 6.2. Separate experiments were carried out to obtain the two product quality indicators. The mass loss was recorded continuously during baking. The cookies for this experiment were prepared as described in Chapter 6 (diameter = 45 mm, height = 6 mm). The center temperature was measured from separate experiments in which the cookies were shaped somewhat differently.

For weight loss investigations three rounds of 12 cookies were baked for approximately 8 min. The cookies were baked with medium air velocity (setting 5), with even top:bottom distribution of air (both dampers set to 50%) and with the air temperature regulation set at 180°C. As described in Section 5.4.1 the trolley moving the air ducts from side to side sometimes touches and lifts the baking tray disturbing the weight measurements. Data obtained for the three baking processes are shown in Figures 8.3(a) and 8.3(b). The final mass fraction was found to be close to 0.88 after 8 min of baking. At the time when the experiments were carried out it was thought that the disturbances from the trolley were too severe for the online obtained measurements to be used. Only the before and after temperature of 6 of the 12 cookies were registered at the time of the experiment. However, the data was logged, and the measurements applied in the present work. Therefore the initial cookie weight is estimated as two times the weight of the 6 measured cookies. While this estimate will result in a small error when calculating the total mass loss, this method is preferred to the off-line method. Measuring the weight after baking will

include additional evaporation from the cookies during cooling and does not show the actual evaporation progress during baking. The scale was not tared systematically, thus the baking tray weight cannot simply be subtracted from the obtained measurements and the approximated mass fraction is applied.

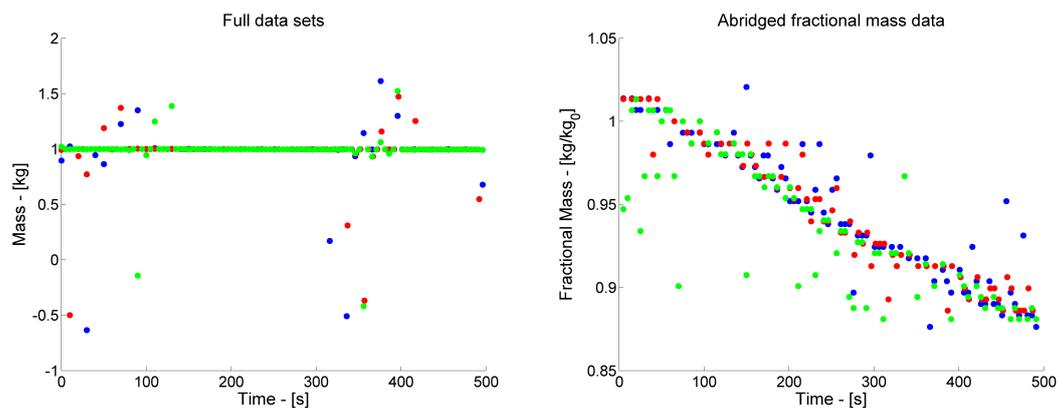

(a) All measured weight data given as mass fractions. (b) Abridged weight data given as mass fractions.

Figure 8.3: Weight measurements from the batch oven. The measurements are normalized against the first 15 measurements in each data set. One of the data sets is shown in Figure 5.8(a).

For center temperature measurements the process of shaping the cookies was different from the standard cookies. Two thin slabs of dough with heights of 3 mm and diameters of 45 mm were prepared. The thermo-sensor tip was placed between the two as close to the center as possible, creating one cookie of 6 mm in height similar to the standard cookies. Temperature data was obtained from six repetitions of three cookies baked under the same conditions as the cookie in the weight loss experiments. Three measurements were discarded due to disturbances in the measurement equipment.

One series of measurements was discarded because the sensor moved through, and out of the cookie surface during baking. Pictures of cookies for temperature measurements are shown in Figure 8.4. For the validation work the average of 14 measurements is applied.

Observations during the experimental work show two main factors which are likely to influence the precision of the center temperature measurements: The thickness of the half cookies, the weight was measured of each half and showed some variation meaning that the top and bottom halves were not completely identical in all cookies; and the risk of sensor movement inside the cookie during baking, while the dough is firm at room temperature, heating will melt the fat in the dough and soften the structure. In Figure 8.5 the temperature measurements are shown, both the raw data from the 14 measurements and the calculated average.

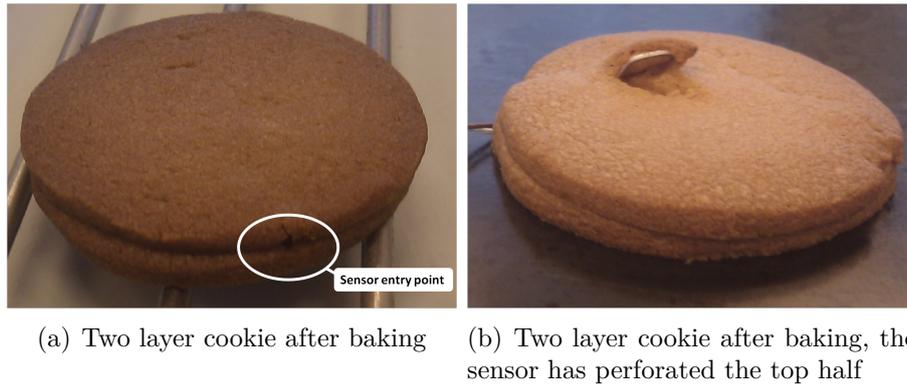

Figure 8.4: Cookies used for the temperature measurements after 15 min of baking. In (a) the two layers are seen along with a small hole left by the sensor wire. (b) shows a case of a sensor which has perforated the cookie during baking.

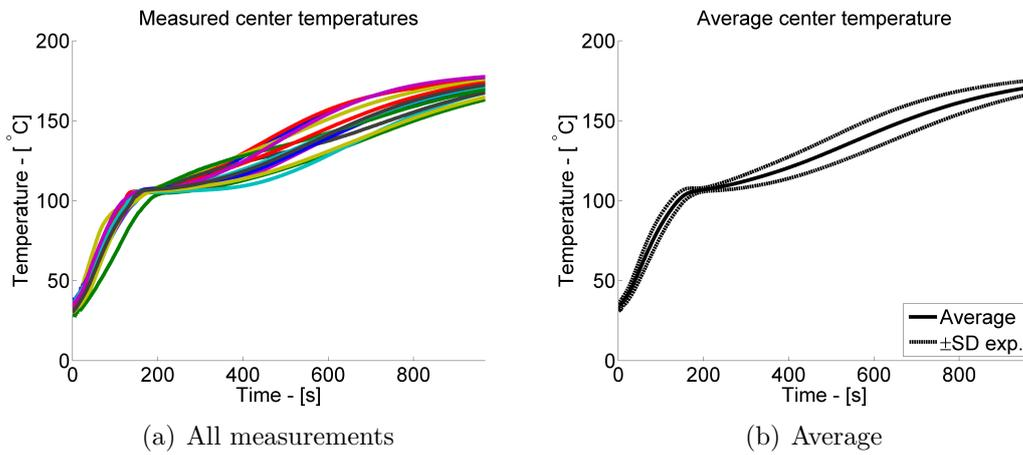

Figure 8.5: Center temperature measurements. (a) All the 14 measurements are shown. (b) The average center temperature \pm one standard deviation.

8.3.2 Initial simulations

Results from simulations using the initial values for k_c ($2.7 \cdot 10^{-6}$ m/s) and D ($3.6 \cdot 10^{-8} \frac{m^2}{s}$) are shown in Figure 8.6 along with experimental results. The two initial values are described in Section 7.2.1.

The initial simulations show almost no evaporation and no temperature increase over 105°C . These results are clearly inconsistent with the actual physical behavior of the product. The heat and mass transfer equations are linked by the mass transfer coefficient and the diffusion coefficient. Directly by the diffusion coefficient which is found in both boundary equations, and indirectly through the mass transfer coefficient which influences the water concentration gradient at the surface, and thus the evaporation term. Considering the boundary equations (7.3) and (7.6) it is seen that the concentration gradient

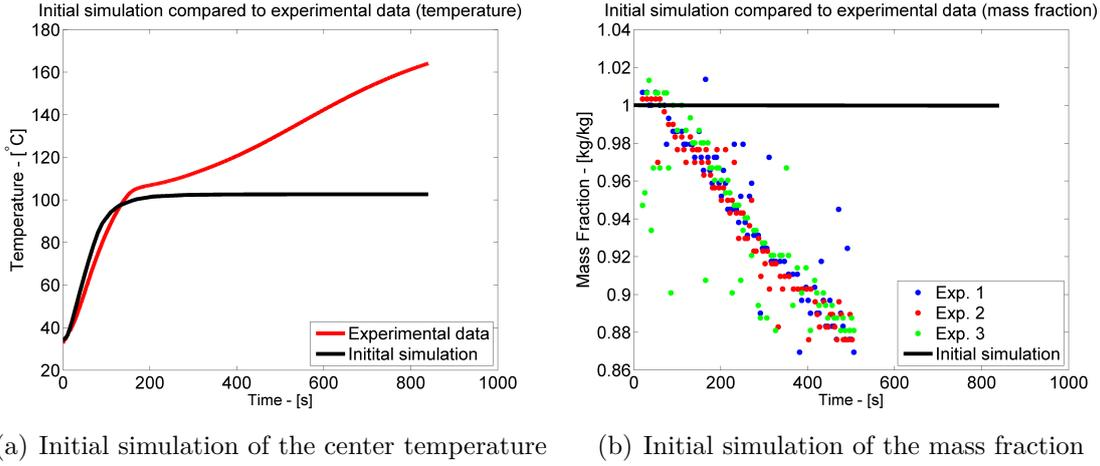

Figure 8.6: Simulation results with the initial diffusion coefficients and experimental results. (a) shows the center temperature and (b) the mass fraction.

may be expressed as (8.2) during the evaporation phase.

$$\frac{\partial x_w}{\partial \bar{n}} = \underbrace{\frac{k_c}{D}}_{\text{constant}} (x_{w,a} - x_w) \quad (8.2)$$

The relation between k_c and D is important for the magnitude of the concentration gradient (left side of (8.2)). From a mechanistic point of view k_c describes how much vapor leaves the surface, while D describes how fast it moves to the surface from the cookie interior. Even with a high mass transfer coefficient the evaporation will not take place if the diffusion is not fast enough to supply water for evaporation at the surface boundary. In the present model such an unbalance may result in a high concentration gradient. This will result in a too high estimate of the energy needed for evaporation in the temperature boundary conditions.

For improved simulations it was estimated that a higher diffusion coefficient was needed and possibly a higher mass transfer coefficient. Using parameter sweeps, as described in Section 8.3.3, the mass transfer and diffusion coefficients were optimized for subsequent simulations.

8.3.3 Improving simulation results by optimizing the mass transfer and diffusion coefficients

The most uncertain parameters in the governing equations are the mass transfer and diffusion coefficients. In order to obtain a balanced result with both heat and mass transfer similar to the experimental data these parameters are to be optimized. The optimization processes in this work are based on comparisons between the experimental data and matrices of 100 simulations. The 100 simulations are combinations of 10 k_c and

10 D values. In COMSOL this is generated as a "parameter sweep" with two variables.

The initial guess for D was $3.6 \cdot 10^{-8} \frac{m^2}{s}$. For liquid water transport this value is in the high end of the expected range, while it is in the lower end of water vapor diffusion coefficients (Hadiyanto et al., 2007; Thorvaldsson and Janestad, 1999). The optimization intervals were chosen based on results from simulations narrowing the possible optimum for each parameter value. The investigated values for were evenly distributed on a logarithmic scale in the following intervals: $k_c \subset [1.78 \cdot 10^{-6} : 5.62 \cdot 10^{-5}] m/s$ and $D \subset [3.16 \cdot 10^{-5} : 1 \cdot 10^{-4}] m^2/s$. Based on published values for diffusion coefficients it is seen that the optimization interval for the diffusion coefficient indicates predominantly water vapor diffusion (Hadiyanto et al., 2007; Thorvaldsson and Janestad, 1999).

The results obtained from the 100 simulations were compared to the experimentally measured mass fractions and the average center temperature. For the baking times at which both experimental and simulation results are obtained the error is calculated from Equation (8.3).

$$\epsilon = \sum_{n=1}^N (x_{n,sim} - x_{n,exp})^2 \quad (8.3)$$

where x_{sim} is the simulated value, x_{exp} is the experimental value and N the number of time steps. The mass fraction error was calculated using all three repetitions. At time steps with more than one repetition the error average value was calculated and included in the total error sum. For the temperature measurements the average temperature for the 14 measurements was used in the error calculations.

The surface plots in Figure 8.7 show the logarithm to the total errors for the temperature and mass fraction, respectively, for all 100 simulations. Figure 8.7(c) shows the logarithm to the product of the error estimate found by (8.4).

$$\epsilon_{combined} = \log(\epsilon_{MF} \cdot \epsilon_{CT}) \quad (8.4)$$

where $\epsilon_{combined}$ is the combined error including the mass fraction error, ϵ_{MF} , and the center temperature error, ϵ_{CT} .

The smallest errors are obtained at the following parameters for the three different set-ups (best fit for mass loss, best fit to temperature, and best fit combined):

$$\begin{aligned} \text{Min. error for mass fraction:} & \quad k_c = 1.21 \cdot 10^{-5} \frac{m}{s}, D = 5.27 \cdot 10^{-5} \frac{m^2}{s} \\ \text{Min. error for temperature:} & \quad k_c = 5.62 \cdot 10^{-6} \frac{m}{s}, D = 4.08 \cdot 10^{-5} \frac{m^2}{s} \\ \text{Min. combined error:} & \quad k_c = 8.25 \cdot 10^{-6} \frac{m}{s}, D = 4.64 \cdot 10^{-5} \frac{m^2}{s} \end{aligned}$$

Results from simulations applying the optimized parameters are shown in Figure 8.8 along with the experimentally measured data. Compared to the initial simulation it is clear that all three simulations provide better descriptions of the baking process. For the temperature profile the step and following increase in temperature is seen in all three optimized cases. The mass loss appear more realistic with a visible drop in mass fraction for all three set-up.

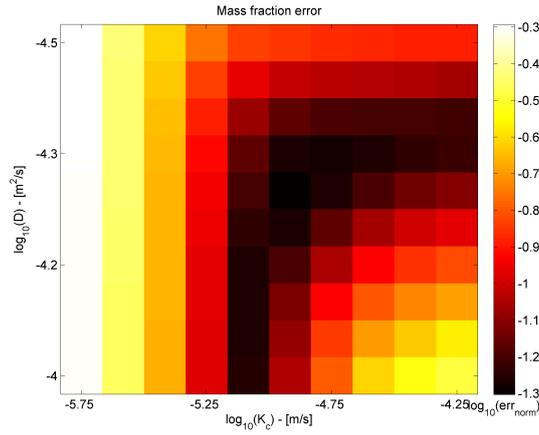

(a) Error for mass fraction

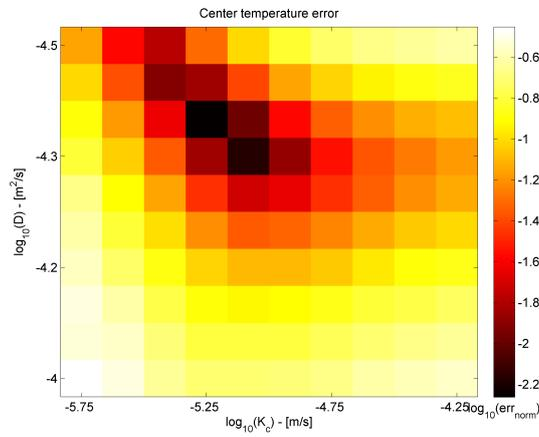

(b) Error for center temperature

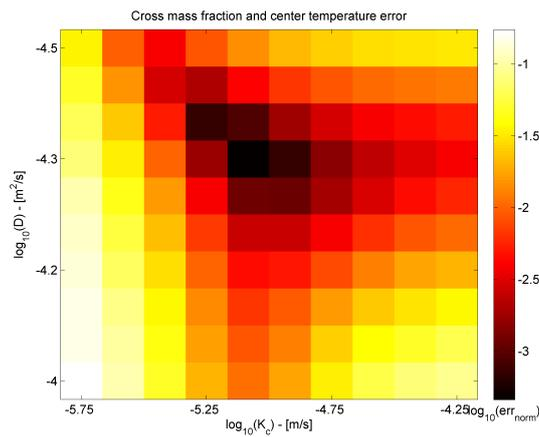

(c) Combined error

Figure 8.7: Visualization of the errors between measured data and simulation results.

Comparing to published values for comparable products the obtained values for k_c and D appear reasonable. The mass transfer coefficient reported by Demirkol et al. (2006b) is $6.19 \cdot 10^{-6} \frac{\text{m}}{\text{s}}$, which is within one order of magnitude compared to the obtained values

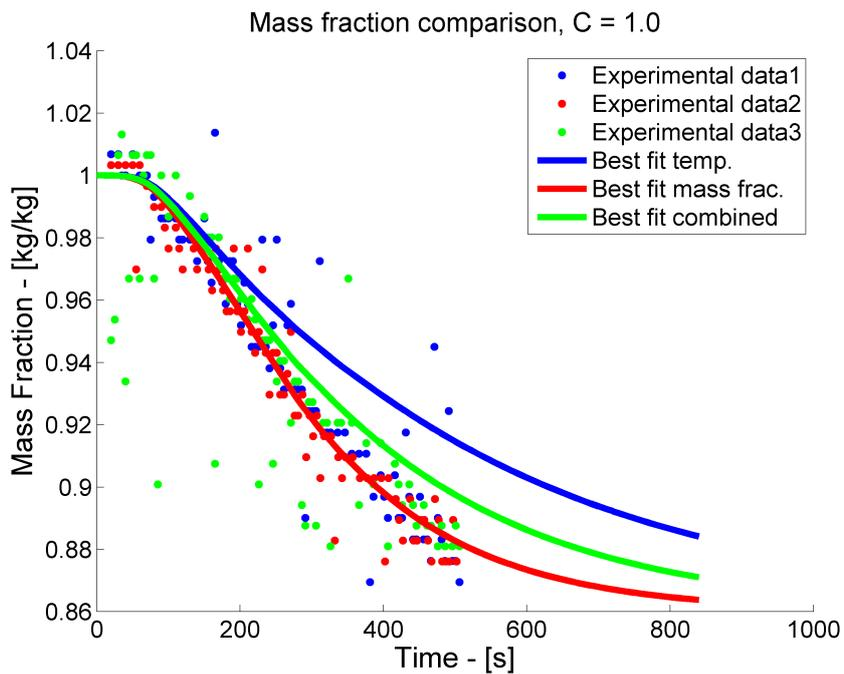
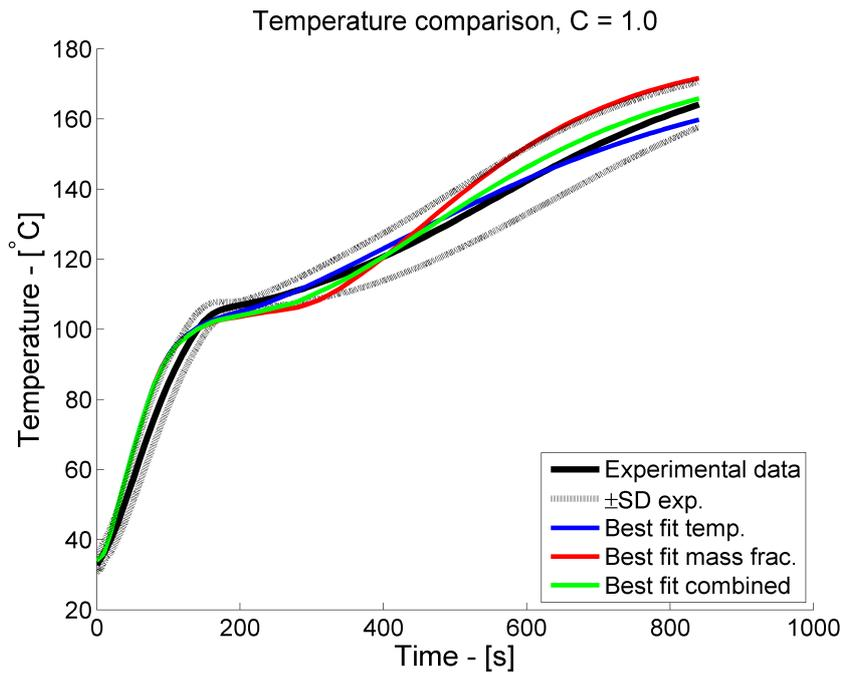

Figure 8.8: Optimized simulation results. (a) shows the simulation results for the center temperature along with the experimental results. (b) shows simulation results and measurements of the mass fractions. The solutions obtained after the first optimization are shown with red dots.

considering best fit for temperature and the combined error.

The applied model does not differentiate between the transfer of liquid or gaseous water transport. An overall diffusion coefficient is found. The found value is very high compared to values for liquid water transport and the initial value. Water diffusion coefficients are generally reported in the order of $10^{-10} \frac{m^2}{s}$ (Hadiyanto et al., 2007; Thorvaldsson and Janestad, 1999; Zanoni et al., 1994). The obtained values strongly indicate that the mass transfer is primarily water vapor moving through the porous structure of the cookies. Diffusion coefficients reported for water vapor are close to the calculated values: Thorvaldsson and Janestad (1999) reports a diffusion coefficient of $8 \cdot 10^{-7} \frac{m^2}{s}$ for bread products, and Hadiyanto et al. (2007) the more related diffusion coefficient for water vapor in biscuits of $2 \cdot 10^{-5} \frac{m^2}{s}$. The latter is close to the results obtained in the present work.

8.4 Discussion of the numerical simulations

The simulations using the FEM tool resulted in good simulations of both the temperature and water evaporation. The initial mass transfer and diffusion coefficients were optimized by the use of experimental data obtained in the new pilot oven. The optimized diffusion coefficients are close to values for water vapor diffusion through biscuit products (Hadiyanto et al., 2007). The initial mass transfer coefficient was within one order of magnitude from the optimized values.

The work presented by Sakin-Yilmazer et al. (2012) also includes mass transfer coefficients inspired by the work of Demirkol et al. (2006b). The values obtained for ring cake baking are seen to exceed the values for butter cookies. Considering the higher water content in cake batter this is expected. The optimized values were between $5.62 \cdot 10^{-6} \frac{m}{s}$ and $1.21 \cdot 10^{-5} \frac{m}{s}$ corresponding well to the value obtained by Demirkol et al. (2006b) of $6.19 \cdot 10^{-6} \frac{m}{s}$ for 100% convection at 190°C for a biscuit product.

The optimized diffusion coefficients were close to the water vapor diffusion coefficients presented by Hadiyanto et al. (2007), and higher than the values presented in Demirkol et al. (2006b). The apparent diffusion coefficient will depend on the structure of the product and its development during baking. Considering the butter cookies the obtained values seem realistic as the porous structure of the product is likely to enable a fast water vapor transport through the product.

In the present case there are known uncertainty aspects attached to both the temperature and weight loss measurements. The weight measurements were influenced by noise from the movement of the trolley and the exact initial weight of the cookies was not known. The temperature sensors may have moved inside the cookies or could have been placed off-center. In future experimental studies alternative temperature measuring methods may need to be considered. Alternative solutions could be a small rig, fixing temperature sensors in predefined positions (Ferrari et al., 2012; Feyissa, 2011), or the sensor cord

could be attached to the underside of the baking tray, then go through a hole in the tray, and allow for an adjustable length of the sensor tip, e.g. half the cookie height (Broyart and Trystram, 2003; Demirkol et al., 2006a). Placing the cookies with the center point on the sensor tip would then enable a more robust center temperature measurement, without additional equipment disturbing the air flow or heat transfer.

The scope of the model is to have a robust description of the heat and mass transfer during baking. Future applications of a robust model could be the optimization of products and/or energy consumption. The simple optimization with two varying parameters improved the simulation of the baking process. A sensitivity study should be considered, as this could disclose any correlations between parameters (Feyissa et al., 2012). The present connection between the heat and mass transfer models is not fully capable of handling the actual physical processes taking place. This would be improved if the mass transfer coefficient and the diffusion coefficients were expressed as functions of the moisture concentration and the temperature.

Based on the results, and investigated published works, water vapor transport appears to be the main mass transfer mechanism inside the cookie during baking. In order to understand the mechanisms of water vapor movement inside the cookies a reasonable future improvement of the model would be to include the porosity. A high degree of porosity forming a continuous network inside the product would facilitate water vapor transport. Additionally the incorporation of air bubbles in the dough may also influence the initial heating of the product. Air from the dough mixing step may decrease the thermal conductivity.

The model gives good results for both heat and mass transfer. An attempt to further improve the model is made by investigating the influence of the baking tray on the mass loss. The simulations in this chapter assume equal evaporation from all surfaces of the butter cookie, and though a good fit is obtained it should be investigated if the model can be improved by including the effect of the solid baking tray surface. In the work presented by Sakin-Yilmazer et al. (2012) different mass transfer coefficients are used at different surfaces due to the degree of coverage by the cake mold.

Chapter 9

Influence of the baking tray on heat and mass transfer

The work described in Chapters 7,8, and 9 is an elaboration of the work presented in the manuscript "Investigation of uneven mass transfer in butter cookies combining experimental work and finite element modeling" (Appendix F), submitted for publication in the International Journal of Food Engineering, June 2013.

This chapter is focused on optimizing the model for heat and mass transfer described in Chapters 7 and 8. The target of the optimization is the mass transfer boundary conditions, in which the effect of the solid baking tray is taken into account. This is done in the numerical simulation set-up by changing the mass flux from the bottom surface. The simulations from Chapter 8 include symmetrical mass transfer boundary conditions. In this chapter the mass flux from the bottom surface is decreased compared to the side and top surfaces.

It is expected that an adjustment of the mass flux boundary conditions from a symmetrical to an asymmetrical set-up will result in a better representation of the heat and mass transfer.

After baking, the top and bottom surfaces of butter cookies show differences with regard to browning and surface topography. An example of a butter cookie, baked in a 10 m tunnel oven (described in Chapter 6) for 6 min at 170°C is shown in Figure 9.1. Bubbles are observed on the bottom surface, which is also darker and more evenly browned than the top surface. The most likely mechanism describing these bubbles is that they arise from water evaporating on the bottom surface when leaving the product. The water vapor then moves along the bottom surface, toward the outer edges, and away from the product. It is interesting to investigate how this evaporation at the bottom surface influences the over-all heat and mass transfer in the product.

In the present work the scope is to develop a robust model, which is sufficiently simple to enable easy modeling, but still complex enough to give a good description of the inves-



(a) Upper surface of butter cookie (b) Bottom surface of butter cookie

Figure 9.1: Upper and bottom surfaces of a cookie baked at 170°C for 6 min in the 10 m tunnel oven described in Chapter 5.

tigated product parameters. The focus is on heat and mass transfer, and the validation of the model is made by comparison with the mass loss and center product temperature data described in Chapter 8.

During baking the baking tray will influence the baking process in two ways: Heat is transferred along the baking tray, adding conduction to the heat transfer at the bottom surface of the cookies. Additionally the baking tray will influence the evaporation rate from the bottom surface. The solid baking tray underneath the cookies will limit evaporation compared to the uncovered top and sides. Different approaches to the influence of baking trays and molds are found in published studies, as described in Section 2.3.3. The two studies of main relevance for the present investigation are those presented by Ferrari et al. (2012) and Sakin-Yilmazer et al. (2012).

The simulation results obtained by Ferrari et al. (2012) clearly show a consequence of not including the limiting effect of a evaporation barrier. An illustration of the simulation compared to the measurements, as given in the article, is shown in Figure 9.2.

Sakin-Yilmazer et al. (2012) include different values for the mass transfer coefficient depending on the degree of coverage by the baking mold. In their modeling work the ratio between the mass transfer coefficients applied for the side and top surfaces is 0.65, and 0.7 between the bottom and top surfaces. The top surface mass transfer coefficient appears to be calculated based on Demirkol et al. (2006b).

The changes are included in the boundary conditions for the mass transfer through the constant C . The boundary conditions for the bottom surface is thus written as shown in (9.1).

$$D \frac{\partial x_w}{\partial \bar{n}} = \begin{cases} 0, & T < T_{vap,w} \\ C \cdot k_c (x_{w,a} - x_w), & T \geq T_{vap,w} \end{cases} \quad (9.1)$$

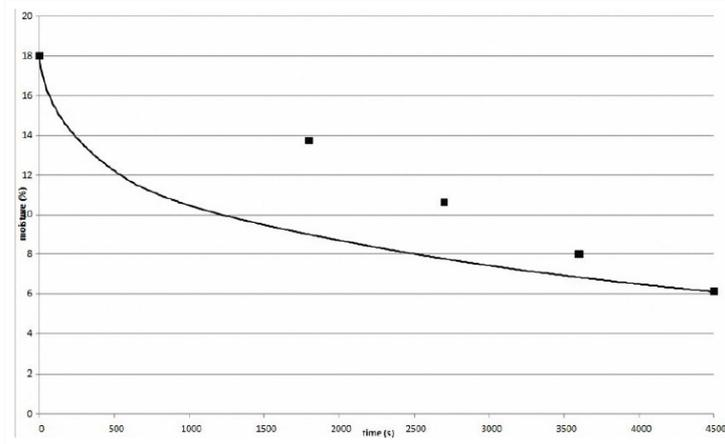

Figure 9.2: Comparison of simulated and measured mass loss for biscuit baking (Ferrari et al., 2012). Caption as given in Ferrari et al. (2012): "Development of biscuit moisture during baking. Solid line corresponds to the model and dots to experimental (%wet basis)."

A total of three different boundary condition scenarios are compared: A symmetrical set-up with 100% ($C = 1.0$) evaporation from the bottom surface, an extreme case with 0% ($C = 0.0$) evaporation from the bottom surface, to include a large variation across the surface, and an intermediate set-up with 60% ($C = 0.6$) evaporation from the bottom surface. All percentages are given relative to the evaporation rate from the top and side surfaces.

9.1 Optimized coefficients

First the case with no mass transfer from the bottom surface ($C = 0.0$) was investigated. Similarly to the parameter optimization work described in Section 8.3.3 a parameter sweep was carried out with 10 values for each k_c and D . Compared to the symmetrical case the investigated interval for D was changed after a few preliminary simulations to include higher values. The mass transfer from the free surfaces will be higher than in the symmetrical case in Chapter 8, therefore higher values are included in the parameter sweep. The investigated intervals were: $k_c \subset [5.62 \cdot 10^{-6} : 1 \cdot 10^{-4}] m/s$ and $D \subset [3.16 \cdot 10^{-5} : 1 \cdot 10^{-4}] m^2/s$.

For the $C = 0.0$ set-up the three combinations of k_c and D resulting in the smallest average deviations, considering the mass fraction (ϵ_{MF}), center temperature (ϵ_{CT}), and the combined minimum error (ϵ_{comb}) were:

$$\begin{aligned}
 \text{Min. error for temperature:} & \quad k_c = 2.78 \cdot 10^{-5} \frac{m}{s}, D = 4.64 \cdot 10^{-5} \frac{m^2}{s} \\
 \text{Min. error for mass fraction:} & \quad k_c = 2.02 \cdot 10^{-5} \frac{m}{s}, D = 6.81 \cdot 10^{-5} \frac{m^2}{s} \\
 \text{Min. combined error:} & \quad k_c = 2.78 \cdot 10^{-5} \frac{m}{s}, D = 4.64 \cdot 10^{-5} \frac{m^2}{s}
 \end{aligned}$$

In all three cases the k_c and D values are within the same order of magnitude. The combinations of k_c and D are the same for ϵ_{CT} and ϵ_{comb} . Of the ten investigated values

of D the same optimum is found for ϵ_{CT} and ϵ_{combi} as was seen for ϵ_{combi} in the $C = 1.0$ set-up.

For the $C = 0.6$ set-up the optimum values must be in the range spanned by the set-ups for $C = 1.0$ and $C = 0.0$. The intervals ranging from the smallest value of the three optimal combination in any of the two set-ups to the maximum value from either of the six combinations were:

$$\begin{aligned} k_c &= 5.62 \cdot 10^{-6} \text{ to } 2.78 \cdot 10^{-5} m/s \\ D &= 4.08 \cdot 10^{-5} \text{ to } 6.81 \cdot 10^{-5} m^2/s \end{aligned}$$

From a 10 by 10 parameter sweep over these intervals the following three optimized combinations were found:

$$\begin{aligned} \text{Min. error for temperature:} & \quad k_c = 8.00 \cdot 10^{-6} \frac{m}{s}, D = 4.17 \cdot 10^{-5} \frac{m^2}{s} \\ \text{Min. error for mass fraction:} & \quad k_c = 1.62 \cdot 10^{-5} \frac{m}{s}, D = 5.17 \cdot 10^{-5} \frac{m^2}{s} \\ \text{Min. combined error:} & \quad k_c = 9.55 \cdot 10^{-6} \frac{m}{s}, D = 4.40 \cdot 10^{-5} \frac{m^2}{s} \end{aligned}$$

These results show smaller k_c values than in the $C = 0.0$ set-up. The D values are still in the same order of magnitude. For the $C = 0.6$ set-up three different combinations of k_c and D were found. Simulation results along with the experimental data are shown in Figures 9.3 and 9.4.

9.2 Simulation results and comparisons

For each set-up k_c and D have been optimized with respect to the mass fraction, the center temperature, and the combined error. Besides the error itself it is important to evaluate the simulated and measured mass fraction and center temperature over time, i.e. during the baking process.

Optimum based on the mass fraction, $C = 0.0$ set-up

The modeling results optimized with regard to the mass fraction (ϵ_{MF}) follows the values of the measured data throughout the baking process. The development of the center temperature follows only the trend of the experimental data (see Figure 9.3). The simulation results are higher than the measurements, but the evaporation plateau is reached at similar baking times and the general pattern in temperature increase is also comparable.

Optimum based on the center temperature, $C = 0.0$ set-up

The simulation results corresponding to the smallest ϵ_{CT} do not provide a good representation of the measured temperature values (Figure 9.3(a)). The impact of removing evaporation completely from the bottom surface results in a too high temperature increase in the center of the cookie. This combination also results in a poor fit for the mass fraction

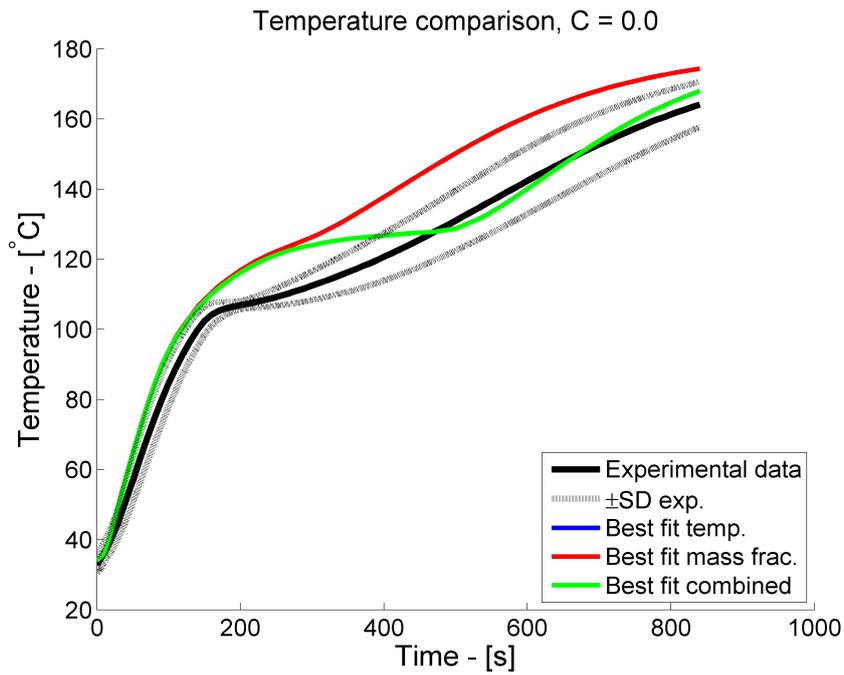

(a) Center temperatures, simulations with 0% evaporation from bottom surface

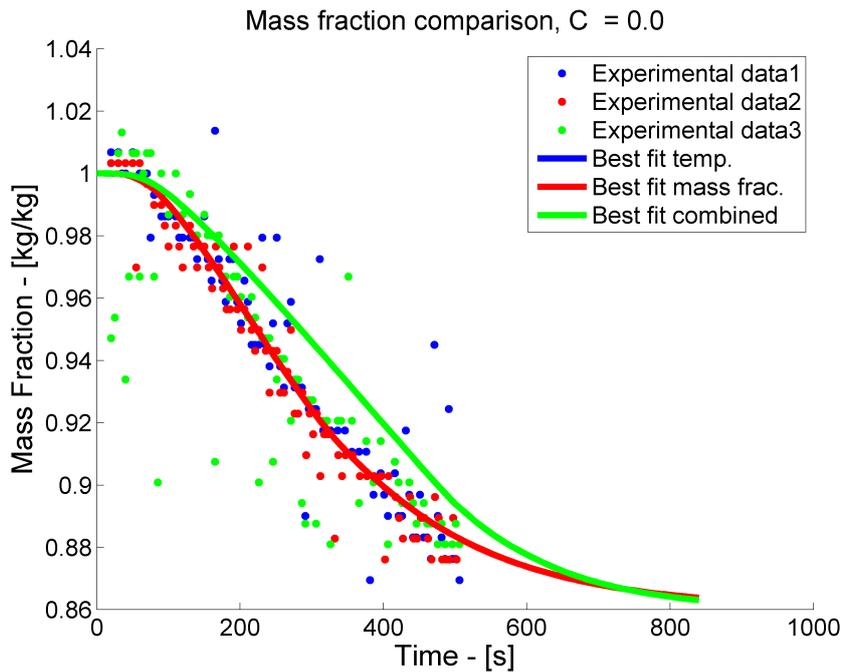

(b) Mass fractions, simulations with 0% evaporation from bottom surface

Figure 9.3: Identical optimization results were obtained for the center temperature and the combined error, therefore only two simulation results are visible in the figures. The center temperature (average, plus and minus one standard deviation) (a) and mass fraction (b) are shown as functions of the baking time. Both the experimental data and the simulations results are shown in the figures.

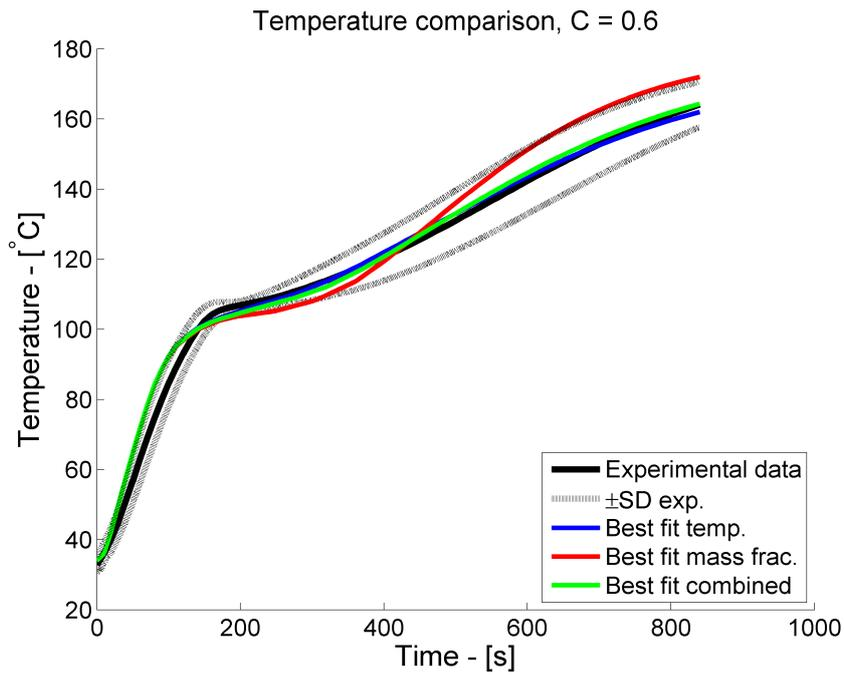

(a) Center temperatures, simulations with 60% evaporation from bottom surface

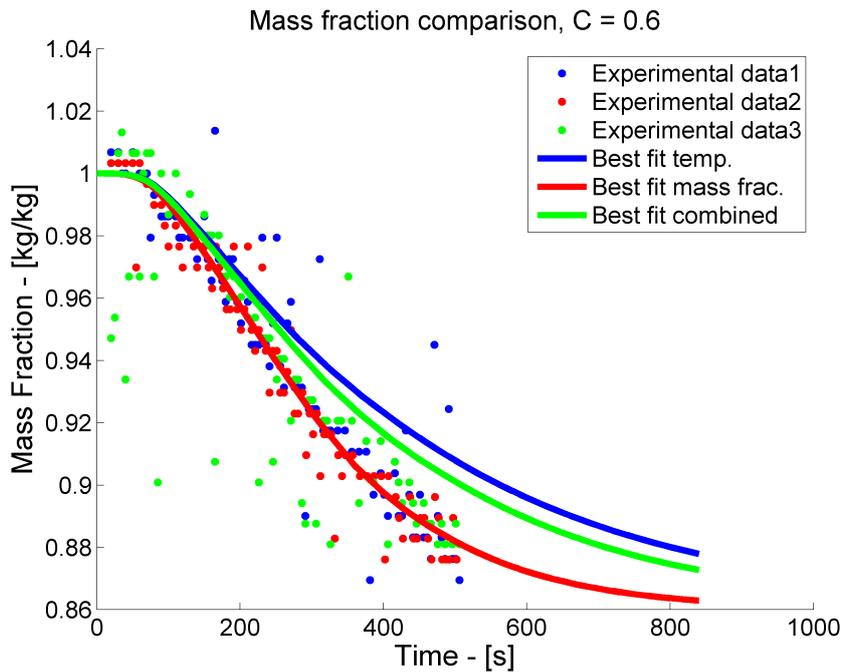

(b) Mass fractions, simulations with 60% evaporation from bottom surface

Figure 9.4: The center temperature (average, plus and minus one standard deviation) (a) and mass fraction (b) are shown as functions of the baking time. Both the experimental data and the simulations results are shown in the figures. The mass transfer from the bottom surface is set to 60% of the top and side surfaces.

development (Figure 9.3(b)). The simulation shows insufficient evaporation compared to the experimental data.

Regarding ϵ_{combi} the optimum combination of parameters is the same as for the center temperature. The poor fit for the center temperature is likely to pull the ϵ_{combi} towards the values resulting in the minimum error for the center temperature.

Comparison of results

For $C = 0.6$ a good fit is seen for the temperature development considering all three combinations of k_c and D (see Figure 9.4). The mass fraction results are quite similar to those obtained with $C = 1.0$ (Chapter 8), showing a high dependency on changes in k_c and D . The k_c and D values given in Table 9.1 were found to give the best fit for the three investigated set-ups. For each set-up three sets of values are given. The first two corresponding to the smallest errors comparing simulation and experimental data for the temperature and the weight loss measurements ($\epsilon_{min,T}$ and $\epsilon_{min,MF}$), calculated from (8.3), and the third set corresponding to the smallest combined error ($\epsilon_{min,combi}$), calculated from (8.4). The smallest calculated errors are also given in the table.

Table 9.1: Error, k_c , and D values corresponding to the lowest temperature, mass fraction or combined error for each of the three set-ups (the C value indicates the factor introduced in (9.1)).

	C = 1.0		
	ϵ value	k_c (m/s)	D (m ² /s)
$\epsilon_{min,T}$	$5.50 \cdot 10^{-3}$	$5.62 \cdot 10^{-6}$	$4.08 \cdot 10^{-5}$
$\epsilon_{min,MF}$	$4.97 \cdot 10^{-2}$	$1.21 \cdot 10^{-5}$	$5.27 \cdot 10^{-5}$
$\epsilon_{min,combi}$	$4.57 \cdot 10^{-4}$	$8.25 \cdot 10^{-6}$	$4.64 \cdot 10^{-5}$
	C = 0.6		
	ϵ value	k_c (m/s)	D (m ² /s)
$\epsilon_{min,T}$	$4.20 \cdot 10^{-3}$	$8.00 \cdot 10^{-6}$	$4.17 \cdot 10^{-5}$
$\epsilon_{min,MF}$	$4.98 \cdot 10^{-2}$	$1.62 \cdot 10^{-5}$	$5.17 \cdot 10^{-5}$
$\epsilon_{min,combi}$	$3.68 \cdot 10^{-4}$	$9.55 \cdot 10^{-6}$	$4.40 \cdot 10^{-5}$
	C = 0.0		
	ϵ value	k_c (m/s)	D (m ² /s)
$\epsilon_{min,T}$	$2.11 \cdot 10^{-2}$	$2.78 \cdot 10^{-5}$	$4.64 \cdot 10^{-5}$
$\epsilon_{min,MF}$	$4.97 \cdot 10^{-2}$	$2.02 \cdot 10^{-5}$	$6.81 \cdot 10^{-5}$
$\epsilon_{min,combi}$	$2.04 \cdot 10^{-3}$	$2.78 \cdot 10^{-5}$	$4.64 \cdot 10^{-5}$

The simulations show that for all three set-ups the model is capable of describing the total mass loss over time. Good agreement is seen between the center temperature measurements and the simulations for $C = 1.0$ and 0.6 . For $C = 0.0$ the model does not result in a good simulation of the center temperature.

Regarding the average errors for the mass fraction the smallest values are found at $C = 0.0$ and $C = 1.0$, however, all minimum errors are very close when the model is optimized

with regard to the mass fraction measurements.

Considering the graphs in Figures 8.8(b), 9.3(b), and 9.4(b) the differences between the investigated parameters are clear. The graphs show that the simulation results optimized with regard to the mass fraction are in good agreement with the average trend in the measured data for all three cases.

Moisture and temperature distribution through the cookies

Figures 9.5 and 9.6 show the temperature profile and mass fractions through the cookie after 300 s for $C = 1.0$ and $C = 0.0$. For the temperature the cross-sectional plots show a clear asymmetry for the case with no evaporation from the bottom surface. In this case the temperature at the bottom surface is highest and the lowest temperature is found at the top and side surfaces at which energy is used both for heating and evaporation.

In the set-up with limited mass transfer some of the calculated temperatures are high, above 140°C , at the bottom surface. The high diffusion coefficient and small mass fraction gradient is likely allowing for a sufficient diffusion drying of the lower surface to reach these temperatures. Considering the pictures of the top and bottom surfaces of cookies baked in a tunnel oven shown in Figure 9.1, the bottom surface is clearly more brown than the top surface. The differences in browning are in agreement with the simulation results with a higher temperature at the bottom surface.

9.3 Model and prediction

A drawback in the simulation-validation work is that the results for validation are also used in the optimization process. The final model's ability to predict the heat and mass transfer in cookies should also be validated against new data, which is not used for optimization. The experimental work described in Chapter 6.4 is used for this purpose. These experiments did not make use of the ovens function of continuous weight measurement. The water loss was measured after the cookies were removed from the oven. Knowing this, the mass loss data is still a way to estimate the predictive capability of the model. Unfortunately no additional temperature measurements were available for comparison.

Because the mass loss was not recorded continuously in the oven during baking the measured evaporation will be higher than the data used to optimize the model. The excess evaporation happens between reaching the desired baking time to the cookie weight is measured. Since the evaporation rate is higher in the first part of the baking the error is expected to decrease with increasing baking time (cf. evaporation rates shown in Figure 6.5(c)). The comparison is shown in Figure 9.7.

The simulation results are shown for the minimum ϵ_{MF} with the $C = 0.6$ set-up. The experimental data points are average values from 6 butter cookies (except at 8 minutes,

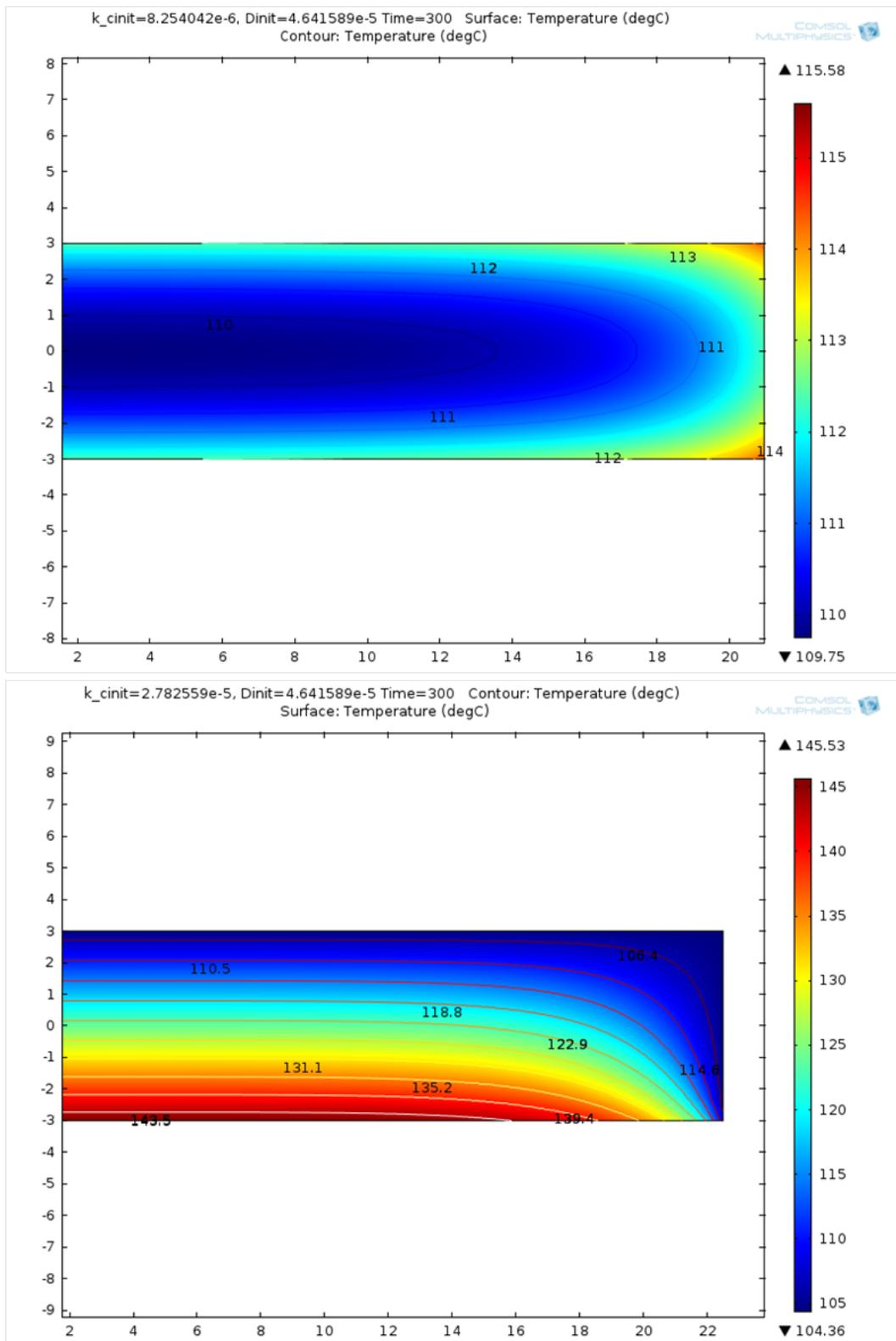

Figure 9.5: Cross-sectional plots of the temperature through the product after 300 s. Upper: With equal mass flux from all surfaces. Lower: Evaporation from only the top and the side surfaces. Note that the color scales are not similar for the two illustrations.

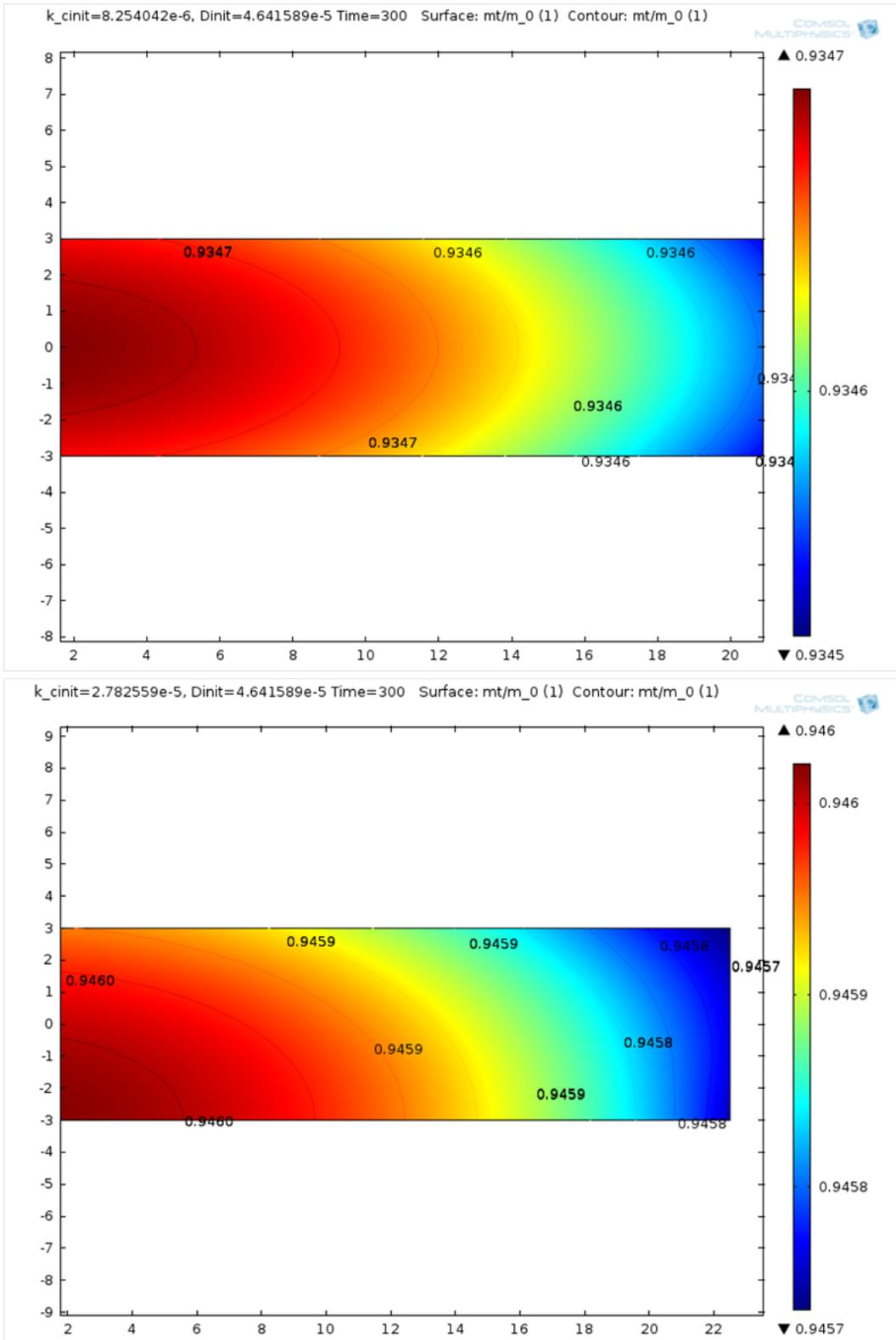

Figure 9.6: Cross-sectional plots of the mass fraction after 300 s. Upper: With equal mass flux from all surfaces. Lower: Evaporation from only the top and the side surfaces. Note that the color scales are not similar for the two illustrations.

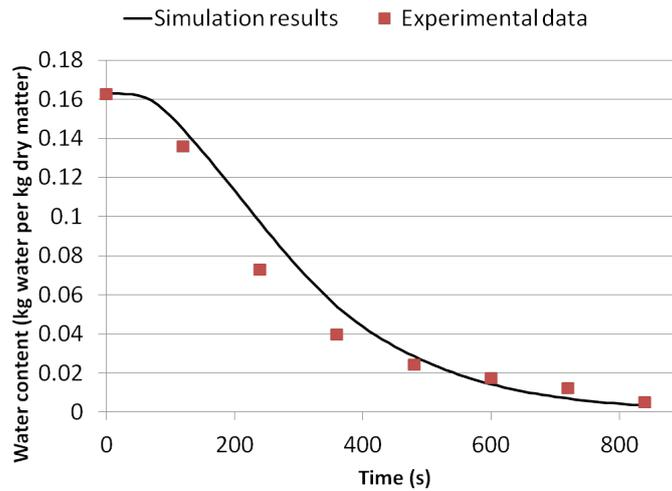

Figure 9.7: Comparison of simulation results and experimental data.

which is an average of 18 butter cookies).

It is seen in Figure 9.7 that the simulated water content is higher than the measured values until a baking time of 480 s. The simulated and measured values thus follow the expected pattern based on the differences in experimental procedures. The agreement between the prediction and the experimental data is very good, showing that the model seems capable of predicting the evaporation progress of water during butter cookie baking.

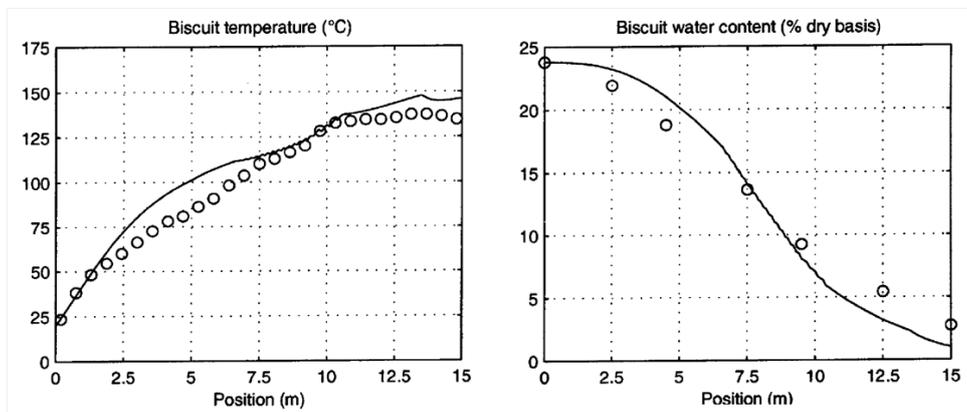

Figure 9.8: Measured (o) and predicted (-) values for biscuit temperature and moisture content during baking, along the length of a tunnel oven (Broyart and Trystram, 2002).

A comparable study was found, modeling the heat and mass transfer during continuous baking of a biscuit product (Broyart and Trystram, 2002). Results for the product temperature and the moisture content in the investigated biscuit are shown in Figure 9.8.

Compared to the results from Broyart and Trystram (2002) the present model provides an excellent prediction of the water content during baking. Considering that the data in Figure 9.7 is not obtained through direct measurements in the new oven, the model is promising as a strong tool for predictions of the butter cookie quality as a function of

baking time.

9.4 Summary

The effect of the baking tray on the evaporation was investigated by changing the mass flux from the bottom surface in butter cookie simulations. Besides the original set-up described in Chapter 8, two additional set-ups were simulated. The original set-up was symmetrical with equal evaporation from all surfaces of the cookie. In the two additional set-ups the evaporation from the bottom surface was 0% ($C = 0.0$) and 60% ($C = 0.6$) of the top and side surfaces, respectively.

The model was seen to give a qualitatively good representation of the baking process. Comparing the three set-ups it was concluded that the symmetrical set-up ($C = 1.0$), with equal evaporation from all surfaces is an acceptable description when heat and mass transfer inside the product is considered. The intermediate set-up ($C = 0.6$) with limited evaporation from the bottom surface provided a slightly better over-all result compared to the symmetrical case. The set-up with no evaporation from the bottom surface ($C = 0.0$) did not give a good representation of the temperature development. When optimized with regard to the mass loss all three set-ups showed good agreement between simulations and measurement data.

When the mass transfer parameters are optimized with regard to mass loss data, acceptable results for the temperature development are obtained with $C = 1.0$ and 0.6 , but not for $C = 0.0$. Calculations of the mass loss, based on parameters optimized with regard to the center temperature, do not render acceptable results in any of the three set-ups. Considering the measured product properties (center temperature and mass loss), optimization using the applied scheme should focus on reaching a good agreement between the simulated and measured mass loss data.

Of the investigated set-ups $C = 0.6$ would be a good initial estimate for further improvement of the model. Similarly to the $C = 0.0$ set-up the bottom surface temperature was higher than at the top and side surfaces. This result is consistent with the higher degree of browning observed on the bottom surface of the butter cookies. For simulations of water evaporation modeling results, using $C = 0.6$, are good when compared to data which was not used in the parameter optimization.

The good agreement regarding the mass loss may be connected to the high diffusion coefficients. These will minimize the effect of the covered surface on the overall transport of water. The good agreement between the symmetrical simulation set-up and the experimental measurements indicates a small effect of the baking tray on the over-all mass loss. While further investigation of other characteristics of the product are needed, the center temperature and total mass loss are not likely to be affected by baking on a perforated or meshed baking tray, compared to the investigated steel sheet plate.

The complexity level of the model is kept relatively simple. The physico-chemical properties are calculated from the dough composition and the transient water content. The mass loss is considered as a lumped process and the porosity is not included. Compared to similar models used to simulate baking of biscuits the obtained simulation results are good. Ferrari et al. (2012) do not obtain a similarly good agreement for the total mass loss (Figure 9.2), but do get a good fit between the measured and calculated product center temperature. The model applied by Broyart and Trystram (2002) appears to reach comparable agreement between measurements and simulations as the new model (Figure 9.8).

More advanced models are primarily applied for cake and bread products. No general measure for the error or quality of presented models have been found. Therefore it is complicated to evaluate modeling results for different products and models in relation to each other. Good results appear to be obtained by Purlis and Salvadori (2009) for modeling bread baking. The crust and crumb temperature as well as the moisture content are calculated in close agreement with the presented measurements. This model includes an evaporation front moving through the product as it reaches 100°C and influencing the physical properties. Whether this could improve the description for the investigated butter cookies is difficult to evaluate from the simulations. It is likely that the additional terms and assumptions needed to increase the physical resolution of the present model will in fact decrease its total accuracy.

The model presented by Zanoni et al. (1994) includes the surface partial pressure as a limit for evaporation, evaporation is only assumed to take place from the free upper surface of a bread product in a mold. However when comparing the experimental data the best fit for the model with this assumption is obtained to data from a mold with a mesh structure. The model presented by Putranto et al. (2011) for baking of a thin layer of cake could be interesting for future comparison. While the highest applied baking temperature is 160°C and few measuring points are included, this model appears to give good simulation results.

The results of my work show good agreement between the continuous measurements and the FEM simulations. For future work the applicability of the model could be broadened and refined in order to capture the full influence of the covered surfaces on the product properties and quality. This could be implemented through additional optimization using data sets containing information such as surface browning.

Chapter 10

Discussion

In the following sections the results of the thesis are revised. The three main topics related to the objectives are discussed. The topics are treated in the same order as they are presented in the thesis.

10.1 Product and quality assessment methods

Based on a literature study, different methods for product quality assessment were reviewed. A new method was investigated in-depth, and the methods selected for quality assessment in the experimental work were presented. Based on the literature review the most frequently applied methods for quality assessment of biscuit products were methods evaluating the appearance and the geometry of the product. For the purpose of the present work one of the most popular methods was selected along with another widely applied measurement: Surface browning and mass loss during baking. Assuming that all mass loss is due to evaporation the total mass loss can be used to calculate the water content in the final product. Additionally, the temperature of the product was measured for the purpose of model validation.

Drying is considered a good parameter for comparison between the simulation results and the experimental data. The experimental procedure is straight forward. The method is non-destructive and the cookie can be used for further evaluation after the weight measurements. The continuous weight measuring system in the new pilot oven was successfully applied in the project.

Evaluation of surface browning was performed in several of the baking experiments. Measuring the surface color is a fast, non-destructive, and intuitive way to evaluate bakery product quality. It is a widely applied approach enabling comparison between different research studies (further references on studies applying surface color evaluation are presented in Section 4.1.3).

Different methods for surface color measurements were used in the presented work: A

categorization, manual colorimeter measurements, extraction of $L^*a^*b^*$ values from digital photography, and image analysis using the VideometerLab system. Which method to choose in future studies would depend on the purpose of the study.

The center temperature was measured for model validation. It is not as such a quality parameter, but can be used to follow the physical development of the product during baking. The measurements were subject to a relatively high uncertainty and some measurements were discarded due to displacement of the temperature sensor. A more reliable temperature measurement system with a better system to fixate the temperature sensors in the product would improve the certainty of these measurements. Such a system would preferably measure the temperature at one or several fixed positions in the product (Broyart and Trystram, 2003; Demirkol et al., 2006a; Ferrari et al., 2012; Feyissa et al., 2011).

The possibilities of a multi-spectral image analysis system for quality assessment of butter cookies have been investigated. The obtained results and the prospects of this method were discussed in relation to, and compared with, more traditional analytical methods.

The method was used to evaluate two different product quality aspects based on one image. Both the surface browning and the product water content were evaluated. A benefit of the multi-spectral imaging method is that it has already shown promising results in assessment studies of other food products (Dissing et al., 2011; Daugaard et al., 2010; Clemmesen et al., 2012).

Good results were not only obtained for browning evaluation. The average water content was determined from the multi-spectral images with an absolute error of 0.22%. The good results for water content predictions are interesting. The option to use one measuring method for multiple quality assessments is relevant for online process control systems, and for this purpose the procedure is considered a promising solution.

10.2 Construction and validation of the new batch oven

Two of the main objectives in this project were 1) the design and construction of a pilot batch oven able to emulate continuous tunnel oven baking, and 2) validation of that oven. The oven was build to emulate continuous, convection baking and simultaneously allow for product and process monitoring. The oven design, construction, and validation carry the weight of the main hypothesis for the project, namely that it is possible to construct a pilot oven with the desired ability to emulate continuous baking processes. In order to prove the hypothesis the first step was to design the oven in close collaboration with employees from Haas-Meincke A/S, including their knowledge of the continuous ovens in the design of the pilot oven. The main focus area of the new oven has been the convective system.

A 10 m tunnel oven located at Haas-Meincke A/S'test bakery in Skovlunde, Denmark, was used for the validation work. The main purpose of the performed validation work was to ensure that the batch oven is capable of providing a comparable air flow to the tunnel oven and to produce products similar to those baked in the tunnel oven. Therefore two stages of validation were carried out. The first focusing on the oven settings and the second on product quality. It was found that similar products were obtained in the two ovens covering a range of oven temperatures.

The purpose of the oven was to create an experimental platform and this influenced the design greatly. Controllable process settings include air velocity, air humidity, air temperature, flexibility regarding baking tray material, and movable air ducts with adjustable distance to the baking tray. The weight of the baking tray is continuously measured, a window for observation was installed, the air humidity, and temperature are continuously logged. Connections for sensors to measure the product temperature are also available. All the logged information is collected in the control computer for further data processing.

The batch oven was constructed to enable experimental work outside normal processing conditions. This was used to investigate the relation between changes in the air flow and the product quality. The oven inlet air flow is adjustable at settings between 0 and 10. Setting 5 was calibrated to the tunnel oven in the validation process. Changes in the inlet air flow were reflected in both browning and weight loss for butter cookies. When the inlet air flow was increased the degree of browning and mass loss were also increased. The results as such are expected, the ability of the oven to produce baking conditions that result in distinctive products is important to validate. The results are very promising for future quantitative studies of the connections between oven settings and bakery product quality.

From the literature study presented in Section 2.3 it is clear that few studies focusing on experimental baking equipment are available, especially concerning continuous baking processes. Ovens combining all three aspects of the new pilot batch oven (controlled baking environment, product monitoring, and emulating tunnel oven baking) were not found elsewhere. Compared to experimental ovens described as a tool for model validation or constructed with the purpose of increasing understanding about baking processes, the new pilot oven is unique. Considering published articles from the last two decades only one oven is described focusing specifically on emulating continuous baking processes (Zareifard et al., 2006).

The oven described by Zareifard et al. (2006) appears to have been through a comprehensive validation process. The validation of that oven against continuous ovens is based on heat flux measurements, resulting in detailed information about the processes. A similar validation would be of great interest for the new batch oven. In the present case the foundation for the validation was the product appearance, point-wise temperature measurements in the tunnel oven, and inlet air velocity measurements. In order to increase the basis of the validation it would also be relevant to characterize additional tunnel ovens for comparison.

Furthermore, a method to characterize the process conditions in the new oven would be expansion of the current CFD simulations of the air flow. Simulations presented by Ferrari et al. (2012) include a larger part of the oven chamber, allowing for simulations which combine the air flow and the heat and mass transfer modeling. CFD simulations of full scale ovens will also enable a more thorough comparison of the expected baking conditions. CFD simulations (both 2D and 3D) of the air flow in continuous ovens were presented in Therdthai (2003, 2004b). The main challenge for such simulations is to find an appropriate level of simplification, both in relation to available computer power for the simulation work and for the investigated process.

The oven presented in this project will provide new opportunities regarding process understanding and options for product monitoring. Some work is still needed to improve the design and functionality of the oven, in order to get the full benefit of the equipment. Especially incorporation of radiation heating and an air flow measuring system will contribute to the possibilities for further research. In this project the concept of the oven has been proven to work and the results obtained in the oven have been used to validate and improve a mathematical model of the baking process.

10.3 Modeling butter cookie baking

Two of the objectives for the project were directly linked to mathematical modeling. Firstly to describe the baking process through a mathematical model that can be solved numerically, and secondly to apply experimental data from the new pilot oven to improve the mathematical model. The second objective furthermore includes that the combination of experimental data and modeling can increase knowledge and understanding of the investigated baking process.

The batch oven was designed and constructed as an experimental platform for validation of models, without the need for industrial experiments in a full scale industrial oven. With robust, applicable models, process planning and re-design of existing processes should be facilitated by minimizing trial-and-error experiments.

The modeling work presented in Chapters 7, 8, and 9 is based on the heat and mass transfer in a two dimensional system. The boundary conditions were chosen to match the investigated process. The heat transfer boundary conditions included a term for evaporation of water when a specified temperature is reached. The mass transfer boundary conditions were equal to zero, until the evaporation temperature was reached, hereafter the evaporation was determined by a constant mass transfer coefficient and the gradient between the water content in the product and the water content in the surrounding air.

10.3.1 Modeling results

The simulation results showed good agreement with the measured data. The results indicate that the model can be used to predict the temperature and water content in butter cookies baked in the new batch oven. The investigated set-up with a 60% evaporation rate from the bottom surface compared to the top and side surfaces ($C = 0.6$) resulted in excellent simulation results for both the temperature and the mass loss. The deviations for the temperature simulations were small, within one standard deviation compared to the measurements, and the simulation results were in good agreement with the mass loss data.

The model was not only applied on the data to which it was fitted. Applying the model to prediction of evaporation for a new data set provided accurate results. The modeling results in this work are good when compared qualitatively to predictions in other published studies on modeling of biscuits products baked in continuous ovens.

Compared to similar studies the obtained simulations resulted in as good or better agreement between experimental data and calculated values. Works including more advanced models did not necessarily give better results than those obtained with the relative simple model in this study (Purlis and Salvadori, 2009; Thorvaldsson and Janestad, 1999; Lostie et al., 2004). Addition of more physical terms, such as the porosity or an evaporation front through the product, would be interesting to investigate. However, it is possible that the determination of such values or terms would complicate the model unnecessarily due to increased parameter uncertainty. Before additional terms are added to the model its robustness should be validated against additional experimental data including varying process conditions.

In the present model much attention was placed on the properties determining the mass transfer properties. The mass transfer and the diffusion coefficients were initially estimated from work presented by Demirkol et al. (2006b). The initial mass transfer coefficient was calculated from an equation given in Demirkol et al. (2006b) and experimental data from the investigated process. The initial average mass transfer coefficient was not far from the optimized values. The average mass transfer value presented in the reference, when baking at 190°C and with forced convection, was in the lower end of the optimized range of mass transfer coefficients found in the present study. Sakin-Yilmazer et al. (2012) also use the work from Demirkol et al. (2006b) to estimate mass transfer coefficients, combined with experimental or estimated values. Their values are differentiated across the cake surface taking the mold into account. The values found in their study are generally higher than the values for the butter cookies, which can be explained by the different water content in the products. The simulation results obtained by Sakin-Yilmazer et al. (2012) describe the progress of the baking process, but there is no description of attempts to optimize the applied mass transfer parameters in order to improve the fit. The mass transfer coefficient depends both on the composition of the product and highly on the process conditions. From the equation given by Demirkol et al. (2006b) continuous mass

loss measurements and knowledge of the product geometry is considered a good way to determine the mass transfer coefficient.

The diffusion coefficient was not directly calculated in the present work. The initial estimate was based on results presented by Demirkol et al. (2006b). However, the final value was found to be much closer to the value presented by Hadiyanto et al. (2007) for water vapor transport in biscuit products. The phase transition of water from liquid to vapor is only explicitly considered in the boundary conditions for the outer surfaces. The diffusion coefficient cannot be easily measured inside the product. Thus the values for this parameter are fitted to the experimental data. The obtained values indicate that a large fraction of the water is present as vapor inside the product. In the study of the influence of the baking tray on mass transfer it is seen that all the obtained optimum values for the diffusion coefficient are very similar (Table 9.1), also they are slightly higher than the value presented by Hadiyanto et al. (2007) for water vapor diffusion. The high diffusion coefficients, combined with the simulation of the moisture distribution in the butter cookies (Figure 9.6), indicate that there is almost no concentration gradient through the product. For larger products such as bread or thick biscuits such gradients have been determined experimentally (Ferrari et al., 2012; Thorvaldsson and Skjoldebrand, 1998; Wagner et al., 2008). The investigated cookies are thin compared to these products, and moisture gradients will be difficult to detect during or after baking due to the uniform nature of the product and its small dimensions.

The consideration of increasing the complexity of the model is two fold. An acceptable model must have a sufficient level of detail to describe the investigated process. Also the model must be possible to apply for different products and at different process conditions with a minimum of adjustments and additional measurements. The model presented in this work appears to have a sufficient level of complexity to calculate the investigated properties for the process of interest. Changes such as the differentiated mass flux was shown to slightly increase the accuracy of the model. Based on the current knowledge and level of model validation no further increase in complexity is suggested before the model is assessed against other products and processing conditions.

Chapter 11

Conclusions

The initial research question creating the foundation for the present work was: *How do process conditions influence characteristics of products during baking in a continuous, convection tunnel oven?* This question is very broad and impossible to answer completely in one PhD project. What has been answered in this project is a part of this question, based on the project hypothesis. The test of the hypothesis has two parts: 1) verifying that a pilot batch oven can emulate production in a continuous tunnel oven, and 2) the experimental data obtained in the oven can be used to increase understanding of the investigated baking process through mathematical modeling.

The two parts of the hypothesis were studied through a number of specific objectives carried out in the project. The first two objectives were focused on the design, construction, and validation of the new pilot batch oven. The results obtained with the oven are promising. Some work is still needed with regard to construction and modification of the oven, a flow measuring system and radiation heating should be included in the design to increase the functionality of the oven. While additional validation experiments could improve the verification of the ovens abilities, the conclusion so far is that the oven is capable of emulating continuous baking processes. It is capable of reproducing a convective baking environment and produce a product quality comparable to that from a convection tunnel oven at similar processing conditions. The option of changing the air velocity was investigated, with the purpose of ensuring that the available range is sufficient to obtain significant changes in the investigated product. This was confirmed, as both the degree of browning and water content were found to vary depending on the inlet air velocity.

After verifying that the batch oven is indeed able to emulate continuous tunnel oven baking the second part of the hypothesis was investigated. This part is related to the third and fourth project objectives. A mathematical model was formulated describing the heat and mass transfer during baking of butter cookies. The model was solved numerically by FEM, and parameters, which were not directly available, were optimized against experimental data from the batch oven. The model was found to give excellent simulations of the heat and mass transfer in the butter cookies.

The model was further used to examine the effect of the baking tray on the evaporation from the butter cookies. The results showed that while the baking tray is likely to reduce the evaporation from the bottom surface, it is not correct to assume that no evaporation takes place at the covered surface. The influence of the baking tray on the browning was not directly investigated, but increased temperature was seen at this surface in the simulation results. From the optimization work included in the modeling work, it was found that the optimum diffusion coefficients were of similar magnitudes in the three investigated set-ups. They were all within the range of water vapor diffusion coefficients for biscuits found in published studies. This information indicates that the main mechanism of water transport in the butter cookies is water vapor diffusion and that this is a rapid process. The consequence of the high diffusion coefficient is a small moisture gradient through the product. This corresponds well to the uniform structure of the final product and is interesting in relation to understanding the product development process.

One final objective was added because of a severe delay in production of the batch oven. This objective is related to reviewing and investigating quality assessment methods applied for bakery products. From the review it was found that the most widely used assessment methods are the surface browning, the geometry of the product, and the changes in water content. A new visual quality assessment method was studied in-depth. The multi-spectral vision system enables simultaneous evaluation of the surface browning and the water content. An automated system based on the presented framework would present a promising system for automated online quality control. The limitation for the system is the need for calibration to each new product.

The work carried out in this project has improved the possibilities for understanding and researching continuous tunnel oven baking. From the project results the project hypothesis has been validated. A better understanding of the influence of the process conditions and baking equipment on the product quality has been obtained through experiments and mathematical modeling.

Chapter 12

Future perspectives

The baking industry is highly energy intensive. It is a big industry with a high product flow. Cost savings in either energy consumption or by increasing the production capacity are therefore important competitive parameters. The work presented in this project may help two different operators in the baking industry, being the product manufacturer and the oven manufacturer.

It has been shown that models can reproduce and predict the performance of baking in the batch oven. This knowledge has the potential to be used for control and optimization of existing processes as well as design of new baking equipment. From the present work both the empirical response surface model based on multi-spectral image analysis (section 4.3) and the more advance physical based mathematical model (Chapter 7) could be used by biscuit or oven manufacturers. Models can be used to find the optimum combination of process conditions for a specific product. Using modeling work it is possible that a optimum product quality could be obtained with a shorter baking time or lower oven temperature than used today.

For the baking industry it is important to know which quality aspects are relevant and how they are best evaluated. For a production facility looking for an online quality control system, a multi-spectral image analysis method is expected to be a good solution based on our results.

Even though the main focus of the baking industry is to produce savory products, more and more focus is put on health issues such as acrylamide¹ formation in bakery products. By studying the combination of drying, surface temperature, and browning, predictions for the amount of produced acrylamide can be obtained from knowledge of its formation process (Ahrne et al., 2007; Zhang and Zhang, 2007; De Vleeschouwer et al., 2008).

The oven manufacturer has been in focus from the beginning of the project. Emphasis has been on the process to product interactions, the design of tunnel ovens, and the possibilities of improving oven design. The pilot batch oven can be used to investigate

¹Carcinogenic product in the Maillard reactions.

new oven design. For example the distance between the inlet air nozzles and the product might be optimized. A higher air flow may increase the heat transfer, and thereby enable a shorter baking time. Experimental work, followed by modeling, as demonstrated in this project, is now possible. This can be further exploited with the new oven.

For successful optimization all aspects discussed in this project are important, both the mechanical construction of pilot scale equipment and the mathematical modeling. Sound experimental settings providing controlled experimental conditions are needed. Robust models, describing the process, validated against the experiments are desirable. From these a modeling environment can be developed, minimizing the need for trial-and-error, and facilitating the process and product optimization.

Bibliography

AACC (2012). AACC, www.aaccnet.org, July 2012.

Abdel-Samie, M. A.-S., Wan, J., Huang, W., Chung, O. K., and Xu, B. (2010). Effects of Cumin and Ginger as Antioxidants on Dough Mixing Properties and Cookie Quality. *Cereal Chemistry*, 87(5):454–460.

Ahrne, L., Andersson, C., Floberg, P., Rosen, J., and Lingnert, H. (2007). Effect of crust temperature and water content on acrylamide formation during baking of white bread: Steam and falling temperature baking. *LWT - Food Science and Technology*, 40(10):1708–1715.

Akingbala, J. O., Falade, K. O., and Ogunjobi, M. A. (2011). The Effect of Root Maturity, Preprocess Holding and Flour Storage on the Quality of Cassava Biscuit. *Food and Bioprocess Technology*, 4:451–457.

Allrecipes.com (2012). allrecipes.com, www.allrecipes.com/recipe/bills-sausage-gravy, July 22nd, 2012.

Arogba, S. S. (2002). Quality characteristics of a model biscuit containing processed mango (*Mangifera Indica*) kernel flour. *International Journal of Food Properties*, 5(2):249–260.

Baik, O. (2000). Cake baking in tunnel type multi-zone industrial ovens Part II. Evaluation of quality parameters. *Food Research International*, 33(7):599–607.

Baik, O. and Marcotte, M. (2003). Modeling the moisture diffusivity in a baking cake. *Journal of Food Engineering*, 56(1):27–36.

Bettge, A. D. and Kweon, M. (2009). Collaborative Study on Updated Method 10-52: Baking Quality of Cookie Flour-Micro Method (Sugar-Snap Cookie). *Cereal Foods World*, 54(2).

Bird, R., Stewart, W., and Lightfoot, E. (2002). *Transport Phenomena*. Wiley International edition. John Wiley & Sons.

Boulet, M., Marcos, B., Dostie, M., and Moresoli, C. (2010). CFD modeling of heat transfer and flow field in a bakery pilot oven. *Journal of Food Engineering*, 97(3):393–402.

- Bourne, M. (2004). Relation between texture and mastication. *Journal of Texture Studies*, 35(2):125–143.
- Broyart, B. and Trystram, G. (2002). Modelling heat and mass transfer during the continuous baking of biscuits. *Journal of Food Engineering*, 51(1):47–57.
- Broyart, B. and Trystram, G. (2003). Modelling of heat and mass transfer phenomena and quality changes during continuous biscuit baking using both deductive and inductive (neural network) modelling principles. *Trans IChemE*, 81(December):316–326.
- Broyart, B., Trystram, G., and Duquenoy, A. (1998). Predicting Colour Kinetics During Cracker Baking. *Journal of Food Engineering*, 35:351–368.
- Capuano, E., Ferrigno, A., Acampa, I., Ait-Ameur, L., and Fogliano, V. (2008). Characterization of the Maillard reaction in bread crisps. *European Food Research and Technology*, 228(2):311–319.
- Carson, J., Willix, J., and North, M. (2006). Measurements of heat transfer coefficients within convection ovens. *Journal of Food Engineering*, 72(3):293–301.
- Carstensen, J. M., Hansen, M. E., Lassen, N. K., and Hansen, P. W. (2006). Creating surface chemistry maps using multispectral vision technology. In *9th Medical Image Computing and Computer Assisted Intervention (MICCAI)*. IMM-Technical Report-2006-17.
- Cauvain, S. and Young, L. (2006). *Baked Products: Science, Technology And Practice*. Blackwell Pub.
- Cauvain, S. and Young, L. (2007). *Technology of Breadmaking*. Springer.
- Chen, H. (1999). Modeling coupled heat and mass transfer for convection cooking of chicken patties. *Journal of Food Engineering*, 42(3):139–146.
- Chevallier, S. (2002). Structural and Chemical Modifications of Short Dough During Baking. *Journal of Cereal Science*, 35(1):1–10.
- Choi, Y. and Okos, M. R. (1986). *Effects of temperature and composition on the thermal properties of foods*, chapter 9, pages 93–101. Food Engineering and Process Applications: Proceedings of the Fourth International Congress on Engineering and Food Held Between 7 and 10 July at Edmonton, Alberta, Canada. Elsevier Applied Science Publishers.
- Clemmesen, L. H., Dissing, B. S., Hyldig, G., and Løje, H. (2012). Multispectral Imaging of Wok-Fried Vegetables. *Journal of Imaging Science and Technology*, 56.
- COMSOL (2012). COMSOL A/S, www.comsol.dk.
- Dansk Standard (2011). "ds/en iso 11664-4 kolorimetri - del 4: L*a*b* - farverum i henhold til cie 1976". Technical report, ISO.

- Datta, A. K. (2008). Status of Models in the Design of Food Products , Processes , and Equipment. *Comprehensive Reviews in Food Science and Food Safety*, 7:121–129.
- Daugaard, S. B., Adler-Nissen, J., and Carstensen, J. M. (2010). New vision technology for multidimensional quality monitoring of continuous frying of meat. *Food Control*, 21(5):626–632.
- Davidek, T. and Davidek, J. (2004). Chemistry of the maillard reaction in foods. In Tomasik, P., editor, *Chemical and Functional Properties of Food Saccharides*, Chemical and Functional Properties of Food Components Series, page Chp. 18. CRC Press.
- De Vleeschouwer, K., Van der Plancken, I., Van Loey, A., and Hendrickx, M. E. (2008). Investigation of the influence of different moisture levels on acrylamide formation/elimination reactions using multiresponse analysis. *Journal of agricultural and food chemistry*, 56(15):6460–70.
- Demirkol, E., Erdogdu, F., and Palazoglu, T. K. (2006a). A Numerical Approach with Variable Temperature Boundary Conditions to Determine the Effective Heat Transfer Coefficient Values During Baking of Cookie. *Journal of food Process Engineering*, 29:478–497.
- Demirkol, E., Erdogdu, F., and Palazoglu, T. K. (2006b). Analysis of mass transfer parameters (changes in mass flux, diffusion coefficient and mass transfer coefficient) during baking of cookies. *Journal of Food Engineering*, 72(4):364–371.
- Demirkol, E., Erdogdu, F., and Palazoglu, T. K. (2006c). Experimental determination of mass transfer coefficient: moisture content and humidity ratio driving force approaches during baking. *Journal of Food Process Engineering*, 29(2):188–201.
- Dissing, B. S., Ersbøll, B. K., and Adler-Nissen, J. (2009). Monitoring water content using multispectral imaging and nir in a minced. In *Abstract from 14th International Conference on Near Infrared Spectroscopy (NIR 2009)*, Bangkok, Thailand.
- Dissing, B. S., Nielsen, M. E., Ersbøll, B. K., and Frosch, S. (2011). Multispectral imaging for determination of astaxanthin concentration in salmonids. *PloS one*, 6(5):e19032.
- Edwards, W. (2007). *The Science of Bakery Products*. Rsc Paperbacks Series. Royal Society of Chemistry.
- Fahloul, D., Trystram, G., Duquenoy, A., and Barbotteau, I. (1994). Modeling Heat and Mass-Transfer in Band Oven Biscuit Baking. *Lebensmittel-Wissenschaft und -Technologie*, 27:119–124.
- Fehaili, S., Courel, M., Rega, B., and Giampaoli, P. (2010). An instrumented oven for the monitoring of thermal reactions during the baking of sponge cake. *Journal of Food Engineering*, 101(3):253–263.

- Ferrari, E., Marai, S. V., Guidetti, R., and Piazza, L. (2012). Modelling of Heat and Moisture Transfer Phenomena During Dry Biscuit Baking by Using Finite Element Method. *International Journal of Food Engineering*, 8(3).
- Feyissa, A. (2011). *Robust Modelling of Heat and Mass Transfer in Processing of Solid Foods*. Phd thesis, DTU National Food Institute, Technical University of Denmark.
- Feyissa, A. H., Gernaey, K. V., and Adler-Nissen, J. (2012). Uncertainty and sensitivity analysis: Mathematical model of coupled heat and mass transfer for a contact baking process. *Journal of Food Engineering*, 109(2):281–290.
- Feyissa, A. H., Gernaey, K. V., Ashokkumar, S., and Adler-Nissen, J. (2011). Modelling of coupled heat and mass transfer during a contact baking process. *Journal of Food Engineering*, 106(3):228–235.
- Goldstein, A. and Seetharaman, K. (2011). Effect of a novel monoglyceride stabilized oil in water emulsion shortening on cookie properties. *Food Research International*, 44(5):1476–1481.
- Grenier, D., Vanin, F., and Lucas, T. (2008). Multiphysics During Bread Making : Numerical Modelling and Technological Teachings from Simulations. In *ISHS Acta Horticulturae 802: IV International Symposium on Applications of Modelling as an Innovative Technology in the Agri-Food-Chain: Model-IT*, pages 147–154.
- Grizotto, R. K., Rufi, C. R. G., Yamada, E. A., and Vicente, E. (2010). Evaluation of the quality of a molded sweet biscuit enriched with okara flour. *Ciência e Tecnologia de Alimentos*, 30:270–275.
- Haas Meincke A/S (2012). Haas-Meincke, www.haas.com.
- HadiNezhad, M. and Butler, F. (2009a). Association of Glutenin Subunit Composition and Dough Rheological Characteristics with Cookie Baking Properties of Soft Wheat Cultivars. *Cereal Chemistry*, 86(3):339–349.
- HadiNezhad, M. and Butler, F. (2009b). Effect of flour type and dough rheological properties on cookie spread measured dynamically during baking. *Journal of Cereal Science*, 49(2):178–183.
- Hadiyanto, Asselman, A., Straten, G. V., Boom, R., Esveld, D., and Boxtel, A. V. (2007). Quality prediction of bakery products in the initial phase of process design. *Innovative Food Science & Emerging Technologies*, 8(2):285–298.
- Hong, S. W., Yan, Z. Y., Otterburn, M. S., and McCarthy, M. J. (1996). Magnetic resonance imaging (MRI) of a cookie in comparison with time-lapse photographic analysis (TLPA) during baking process. *Magnetic Resonance Imaging*, 14(7/8):923–927.
- Huang, H., Lin, P., and Zhou, W. (2007). Moisture transport and diffusive instability during bread baking. *Siam Journal of Applied Mathematics*, 68(1):222–238.

- HunerLab (2012). HunterLab, www.hunterlab.com/appnotes/an07_96a.pdf, June 7, 2012.
- Jacob, J. and Leelavathi, K. (2007). Effect of fat-type on cookie dough and cookie quality. *Journal of Food Engineering*, 79(1):299–305.
- Jensen, B., Friis, A., and Adler-Nissen, J. (2003). *Hygienic Design of Closed Processing Equipment by use of Computational Fluid Dynamics*. BioCentrum-DTU.
- Jensen, B. B., Lennox, M., Granby, K., and Adler-Nissen, J. (2008). Robust modelling of heat-induced reactions in an industrial food production process exemplified by acrylamide generation in breakfast cereals. *Food and Bioproducts Processing*, 86(3):154–162.
- Kweon, M., Slade, L., and Levine, H. (2011). Development of a Benchtop Baking Method for Chemically Leavened Crackers. I. Identification of a Diagnostic Formula and Procedure. *Cereal Chemistry*, 88(1):19–24.
- Latimer, H. L. and Watts, A. S. (1936). The influence of drying treatment and biscuit storage atmosphere on the physical properties of a semiporcelain body. *Journal of the American ceramic society*, 19:121–126.
- Lostie, M., Peczalski, R., and Andrieu, J. (2004). Lumped model for sponge cake baking during the "crust and crumb" period. *Journal of Food Engineering*, 65(2):281–286.
- Lostie, M., Peczalski, R., Andrieu, J., and Laurent, M. (2002a). Study of sponge cake batter baking process . Part I : Experimental data. *Journal of Food Engineering*, 51:131–137.
- Lostie, M., Peczalski, R., Andrieu, J., and Laurent, M. (2002b). Study of sponge cake batter baking process. II. Modeling and parameter estimation. *Journal of Food Engineering*, 55(4):349–357.
- Maache-Rezzoug, Z., Bouvier, J.-M., Allaf, K., and Patras, C. (1998). Effect of Principal Ingredients on Rheological Behaviour of Biscuit Dough and on Quality of Biscuits. *Journal of Food Engineering*, 35:23–42.
- Mamat, H., Abu Hardan, M. O., and Hill, S. E. (2010). Physicochemical properties of commercial semi-sweet biscuit. *Food Chemistry*, 121(4):1029–1038.
- Manley, D. (1998a). *Biscuit, Cookie, and Cracker Manufacturing, Manual 2: Doughs*. Number vb. 1 in Biscuit, Cookie and Cracker Manufacturing Manuals. Woodhead.
- Manley, D. (1998b). *Biscuit Packaging and Storage*. Number vb. 6 in Biscuit, Cookie and Cracker Manufacturing Manuals. Woodhead.
- Manley, D. J. R. (2011). *Manley's Technology of Biscuits, Crackers and Cookies*. Woodhead Publishing Series in Food Science, Technology and Nutrition. Woodhead Publishing, 4th edition.

- Manohar, R. S., Rao, P. H., Manohar, R. S., and Rao, P. H. (1999). Effect of mixing method on the rheological characteristics of biscuit dough and the quality of biscuits. *European Food Research and Technology*, 210(1):43–48.
- Marcroft, H. E., Chandrasekaran, M., and Karwe, M. V. (1999). Flow field in a hot air jet impingement oven - part II: Multiple impingement jets. *Journal of food processing preservation*, 23(732):235–248.
- Markowski, M. (1997). Air Drying of vegetables: evaluation of mass transfer coefficient. *Journal of Food Engineering*, 34:55–62.
- Martinez-Navarrete, N., Moraga, G., Talens, P., and Chiralt, A. (2004). Water sorption and the plasticization effect in wafers. *International Journal of Food Science and Technology*, 39(5):555–562.
- Martins, R. C., Lopes, V. V., Vicente, A. A., and Teixeira, J. A. (2008). *Numerical Solutions: Finite Element and Finite Volume Methods*, pages 1–13. Contemporary Food Engineering. CRC Press.
- McFarlane, I. (2006). Control of final moisture content of food products baked in continuous tunnel ovens. *Measurement Science and Technology*, 17(2):241–248.
- McGee, H. (2004). *On Food and Cooking: The Science and lore of the Kitchen*. Scribner.
- Mills, A. (1995). *Basic heat and mass transfer*. The Richard D. Irwin series in heat transfer. Irwin.
- Mills, E., Wilde, P., Salt, L., and Skeggs, P. (2003). Bubble formation and stabilization in bread dough. *Food and Bioproducts Processing*, 81(3):189 – 193.
- Mirade, P., Daudin, J., Ducept, F., Trystram, G., and Clement, J. (2004). Characterization and CFD modelling of air temperature and velocity profiles in an industrial biscuit baking tunnel oven. *Food Research International*, 37(10):1031–1039.
- Mochizuki, Y. (2001). *Texture Profile Analysis. Current Protocols in Food Analytical Chemistry*. John Wiley and Sons, Inc.
- Møller, C. G. (2012). The influence of temperature and humidity during baking on the quality of swiss roll cakes. Bachelor Thesis, Technical University of Denmark, National Food Institute.
- Monaci, L., Brohée, M., Tregoat, V., and van Hengel, A. (2011). Influence of baking time and matrix effects on the detection of milk allergens in cookie model food system by ELISA. *Food Chemistry*, 127(2):669–675.
- Mondal, A. and Datta, A. K. (2008). Bread baking - A review. *Journal of Food Engineering*, 86(4):465–474.

- Mondal, A. and Datta, A. K. (2010). Two-dimensional CFD modeling and simulation of crustless bread baking process. *Journal of Food Engineering*, 99(2):166–174.
- Mondal, A. and Datta, A. K. (2011). Investigation of the Process Parameters Using Response Surface Methodology on the Quality of Crustless Bread Baked in a Water-Spraying Oven. *Journal of Food Process Engineering*, 34(6):1819–1837.
- Mowbray, W. R. (1981). Technology of the "hot box". *Food Manufacture*, 56(10):27–30.
- Ni, H. and Datta, A. (1999). Heat and moisture transfer in baking of potato slabs. *Drying Technology*, 17(10):2069–2092.
- Nishio, Z., Oikawa, I. H., Haneda, I. T., Seki, I. M., Tabiki, T., Yamauchi, I. H., and Miura, H. (2009). Influence of Amylose Content on Cookie and Sponge Cake Quality and Solvent Retention Capacities in Wheat Flour. *Cereal Chemistry*, 86(3):313–318.
- Nitin, N. and Karwe, M. V. (2001). Heat transfer coefficient for cookie shaped objects in a hot air jet impingement oven. *Journal of Food Process Engineering*, 24:51–69.
- Olszewski, E. A. (2006). From baking a cake to solving the diffusion equation. *American Journal of Physics*, 74(6):502.
- Orograin Bakeries Products, Inc. (2012). Thomas' English Muffins, www.thomasbagels.com, July 22nd, 2012.
- Ousegui, A., Moresoli, C., Dostie, M., and Marcos, B. (2010). Porous multiphase approach for baking process - explicit formulation of evaporation rate. *Journal of Food Engineering*, 100(3):535–544.
- Özboy Özbas, O., Seker, I. T., and Gökbulut, I. (2010). Effects of resistant starch, apricot kernel flour, and fiber-rich fruit powders on low-fat cookie quality. *Food Science and Biotechnology*, 19(4):979–986.
- Ozturk, S., Ozbas, O. O., Javidipour, I., and Koksel, H. (2009). Effects of zero-trans interesterified and non-interesterified shortenings and brewer's spent grain on cookie quality. *Journal of Food Lipids*, 16:297–313.
- Pace, M., De Bonis, M. V., Marra, F., and Ruocco, G. (2011). Characterization of a combination oven prototype: Effects of microwave exposure and enhanced convection to local temperature rise in a moist substrate. *International Communications in Heat and Mass Transfer*, 38(5):557–564.
- Pareyt, B., Brijs, K., and Delcour, J. A. (2010). Impact of Fat on Dough and Cookie Properties of Sugar-Snap Cookies. *Cereal Chemistry*, 87(3):226–230.
- Pareyt, B. and Delcour, J. a. (2008). The role of wheat flour constituents, sugar, and fat in low moisture cereal based products: a review on sugar-snap cookies. *Critical reviews in food science and nutrition*, 48(9):824–39.

- Pedersen, S. (2009). Baking consultant, personal communication.
- Perkins (2012). Baker Perkins, "Baker Perkins in the bakery industry", www.bphs.net, July 24nd, 2012.
- Perrot, N., Trystram, G., Le Guennec, D., and Guely, F. (1996). Sensor Fusion for Real Time Quality Evaluation of Biscuit during Baking. Comparison between Bayesian and Fuzzy Approaches. *Journal of Food Engineering*, 29:301–315.
- Ploteau, J. P., Nicolas, V., and Glouannec, P. (2012). Numerical and experimental characterization of a batch bread baking oven. *Applied Thermal Engineering*, 48.
- Pomeranz, Y. and Shellenberger, J. (1971). *Bread science and technology*. (Avi Books). Avi Pub. Co.
- Purlis, E. (2010). Browning development in bakery products - a review. *Journal of Food Engineering*, 99(3):239–249.
- Purlis, E. (2011). Bread baking: Technological considerations based on process modelling and simulation. *Journal of Food Engineering*, 103(1):92–102.
- Purlis, E. (2012). Baking process design based on modelling and simulation: Towards optimization of bread baking. *Food Control*, 27(1):45–52.
- Purlis, E. and Salvadori, V. O. (2007). Bread browning kinetics during baking. *Journal of Food Engineering*, 80(4):1107–1115.
- Purlis, E. and Salvadori, V. O. (2009). Bread baking as a moving boundary problem. Part 1: Mathematical modelling. *Journal of Food Engineering*, 91(3):428–433.
- Putranto, A., Chen, X. D., and Zhou, W. (2011). Modeling of baking of thin layer of cake using the lumped reaction engineering approach (L-REA). *Journal of Food Engineering*, 105(2):306–311.
- Rathore, M. and Kapuno, R. (2011). *Engineering Heat Transfer*. Jones & Bartlett Learning.
- Romani, S., Balestra, F., Angioloni, A., Rocculi, P., and Rosa, M. D. (2012). Physico-chemical and electronic nose measurements on the study of Biscuit Baking kinetics. *Italian Journal of Food Science*, 24:32–41.
- Sablani, S., Marcotte, M., Baik, O., and Castaigne, F. (1998). Modeling of Simultaneous Heat and Water Transport in the Baking Process. *LWT - Food Science and Technology*, 31(3):201–209.
- Saha, S., Gupta, A., Singh, S., Bharti, N., Singh, K., Mahajan, V., and Gupta, H. (2011). Compositional and varietal influence of finger millet flour on rheological properties of dough and quality of biscuit. *LWT - Food Science and Technology*, 44(3):616–621.

- Sakin, M., Kaymak-Ertekin, F., and Ilicali, C. (2007a). Modeling the moisture transfer during baking of white cake. *Journal of Food Engineering*, 80(3):822–831.
- Sakin, M., Kaymak-Ertekin, F., and Ilicali, C. (2007b). Simultaneous heat and mass transfer simulation applied to convective oven cup cake baking. *Journal of Food Engineering*, 83(3):463–474.
- Sakin, M., Kaymak-Ertekin, F., and Ilicali, C. (2009). Convection and radiation combined surface heat transfer coefficient in baking ovens. *Journal of Food Engineering*, 94(3-4):344–349.
- Sakin-Yilmazer, M., Kaymak-Ertekin, F., and Ilicali, C. (2012). Modeling of simultaneous heat and mass transfer during convective oven ring cake baking. *Journal of Food Engineering*, 111(2):289–298.
- Sarkar, A. and Singh, R. P. (2003). Spatial Variation of Convective Heat Transfer Coefficient in Air Impingement Applications. *Journal of Food Science*, 68(3):910–916.
- Savoie, I., Trystram, G., Brunet, P., and Marchin, F. (1992). Heat and Mass Transfer Dynamic Modelling of an Indirect Biscuit Baking Tunnel-Oven . Part I : Modelling Principles. *Food Engineering*, 16:173–196.
- Seker, I. T., Özboy Özbas, O., Gökbulut, I., Öztürk, S., and Köksel, H. (2009). Effects of Fiber-rich Apple and Apricot Powders on Cookie Quality. *Food Science and Biotechnology*, 18(4):948–953.
- Senter, J. and Sollicc, C. (2007). Flow field analysis of a turbulent slot air jet impinging on a moving flat surface. *International Journal of Heat and Fluid Flow*, 28(4):708–719.
- Sindhuja, A., Sudha, M. L., and Rahim, A. (2005). Effect of incorporation of amaranth flour on the quality of cookies. *European Food Research and Technology*, 221(5):597–601.
- Singh, R. and Heldman, D. (2009). *Introduction to Food Engineering*. Food Science and Technology Series. Academic Press.
- Skaarup, B. (2011). *Bag brødet: dansk brød og bagning gennem 6.000 år*. Gyldendal.
- Sommier, A., Anguy, Y., Dumoulin, E., Rojas, J., and Vignolle, M. (2011). On the use of combined heat flux measurements and image analysis procedures for the change of scale between industrial and pilot ovens. *Procedia Food Science*, 1(Icef 11):1165–1172.
- Sommier, A., Chiron, H., Colonna, P., Valle, G. D., and Rouillé, J. (2005). An instrumented pilot scale oven for the study of french bread baking. *Journal of Food Engineering*, 69(1):97 – 106.
- Sommier, A., Dumoulin, E., Douiri, I., and Chipeau, C. (2012). Characterization of sponge cake baking in an instrumented pilot oven. *International Journal of Food Studies*, 1(2).

- Starbucks (2012). Starbucks, www.starbucks.com/menu/food/bakery, July 22nd, 2012.
- Sterner, D., Sundén, B., and Skjöldebrand, C. (2002). Predictive modelling of heat and mass transfer in hamburger patties. In *Seventh International Conference on Advanced Computational Methods in Heat Transfer. Heat Transfer VII* ., pages 283 – 292.
- Stevenson, S. G., Fok, P. Y., and Edwards, N. M. (2010). Evaluating Sugar-Snap Cookie Quality Using Digital Image Analysis. *Cereal Chemistry*, 87(2):137–140.
- Texture Technologies (2012). Texture Technologies Corp, www.texturetechnologies.com.
- The Guardian (2012). The Guardian, www.guardian.co.uk/lifeandstyle/2012/jun/06/crunch-time-britain-loves-biscuits, July 22nd, 2012.
- Therdthai, N. (2003). Two-dimensional CFD modelling and simulation of an industrial continuous bread baking oven. *Journal of Food Engineering*, 60(2):211–217.
- Therdthai, N. (2004a). Simulation of starch gelatinisation during baking in a travelling-tray oven by integrating a three-dimensional CFD model with a kinetic model. *Journal of Food Engineering*, 65(4):543–550.
- Therdthai, N. (2004b). Three-dimensional CFD modelling and simulation of the temperature profiles and airflow patterns during a continuous industrial baking process. *Journal of Food Engineering*, 65(4):599–608.
- Thorvaldsson, K. and Janestad, H. (1999). A model for simultaneous heat, water and vapour diffusion. *Journal of Food Engineering*, 40(3):167–172.
- Thorvaldsson, K. and Skjoldebrand, C. (1998). Water Diffusion in Bread During Baking. *Lebensmittel-Wissenschaft und-Technologie*, 31:658–663.
- Tijsskens, L., Hertog, L., and Nicolaï, B. (2001). *Food Process Modelling*. Woodhead Publishing Series in Food Science and Technology. Woodhead.
- Trystram, G. (2012). Modelling of food and food processes. *Journal of Food Engineering*, 110(2):269–277.
- Villadsen, J. and Michelsen, L. (1978). *Solution of Differential Equation Models by Polynomial Approximation*. Prentice-Hall international series in the physical and chemical engineering sciences. Prentice-Hall.
- Wade, P. (1987). Biscuit Baking by Near-infrared Radiation. *Journal of Food Engineering*, 6:165–175.
- Wagner, M. J., Loubat, M., Sommier, A., Le Ray, D., Collewet, G., Broyart, B., Quintard, H., Davenel, A., Trystram, G., and Lucas, T. (2008). MRI study of bread baking: experimental device and MRI signal analysis. *International Journal of Food Science & Technology*, 43(6):1129–1139.

- Wählby, U. (2002). *Heat and Mass Transfer in Impingement Cooking Aspects of Food Quality*. Phd thesis, Chalmers University of Technology.
- Wählby, U., Skjöldebrand, C., and Junker, E. (2000). Impact of impingement on cooking time and food quality. *Journal of Food Engineering*, 43:179–187.
- Wang, L. and Sun, D.-W. (2003). Recent developments in numerical modelling of heating and cooling processes in the food industry - a review. *Trends in Food Science & Technology*, 14(10):408–423.
- Yam, K. L. and Papadakis, S. E. (2004). A simple digital imaging method for measuring and analyzing color of food surfaces. *Journal of Food Engineering*, 61(1):137–142.
- Zanoni, B., Peri, C., and Bruno, D. (1995). Modelling of browning kinetics of bread crust during baking. *Lebensmittel-Wissenschaft und-Technologie*, 28(6):604–609.
- Zanoni, B., Pierucci, S., and Peri, C. (1994). A study of the Bread-Baking Process. II. Mathematical Modelling. *Journal of Food Engineering*, 23:321–336.
- Zareifard, M., Boissonneault, V., and Marcotte, M. (2009). Bakery product characteristics as influenced by convection heat flux. *Food Research International*, 42(7):856–864.
- Zareifard, M., Marcotte, M., and Dostie, M. (2006). A method for balancing heat fluxes validated for a newly designed pilot plant oven. *Journal of Food Engineering*, 76(3):303–312.
- Zhang, J., Datta, A. K., and Mukherjee, S. (2005). Transport processes and large deformation during baking of bread. *AIChE Journal*, 51(9):2569–2580.
- Zhang, Y. and Zhang, Y. (2007). Formation and reduction of acrylamide in Maillard reaction: a review based on the current state of knowledge. *Critical reviews in food science and nutrition*, 47(5):521–42.
- Zhou, W. (2005). Application of FDM and FEM in solving the simultaneous heat and moisture transfer inside bread during baking. *International Journal of Computational Fluid Dynamics*, 19(1):73–77.
- Zoulias, E. I., Oreopoulou, V., and Tzai, C. (2000). Effects of fat mimetis on physical, textural and sensory properties of cookies. *International Journal of Food Properties*, 3(3):385–397.

Appendices

The following appendices are included:

Appendix A: Article: Quality assessment of butter cookies applying multi-spectral imaging

Appendix B: Abstract and poster: A mechanistic approach to baking processes

Appendix C: Poster: Design and construction of a batch oven for investigation of industrial continuous baking processes

Appendix D: Article: Design and construction of a batch oven for investigation of industrial continuous baking processes

Appendix E: Abstract: Investigating the influence of air velocity on the quality of butter cookies

Appendix F: Article manuscript: Investigation of uneven mass transfer in butter cookies combining experimental work and finite element modeling

Appendix G: Literature search for state of the art articles

Appendix H: Literature review for quality assessment

Appendix I: ANOVA testing influence of air flow

Appendix J: Parameters and variables for COMSOL simulations

Appendix A

Article: Quality assessment of butter cookies applying multi-spectral imaging

This appendix contains the article “*Quality assessment of butter cookies applying multi-spectral imaging*” published in *Food Science & Nutrition*, June 12, 2013.

ORIGINAL RESEARCH

Quality assessment of butter cookies applying multispectral imaging

Mette S. Andresen, Bjørn S. Dissing & Hanne Løje

National Food Institute, Technical University of Denmark, Søtofts Plads 227, DK-2800 Kongens Lyngby, Denmark

Keywords

Baking, browning, cookie, food technology, food quality, multispectral imaging, water content

Correspondence

Mette S. Andresen, National Food Institute, Technical University of Denmark, Søtofts Plads 227, DK-2800 Kongens Lyngby, Denmark.
Tel: +45 45 25 29 56; Fax: +45 45 93 96 00; E-mail: metst@food.dtu.dk

Funding Information

This study was supported by the Danish Ministry of Food, Agriculture and Fisheries.

Received: 4 March 2013; Revised: 2 April 2013; Accepted: 21 April 2013

doi: 10.1002/fsn3.46

Introduction

In cookie production, visual quality is of very high importance. To ensure that the quality is constantly in accordance with the specifications, it is inspected regularly throughout the production day, so that the process can be adjusted immediately if needed. Traditionally, such control and quality checking is done by human expert operators. Even though it can be advantageous to have expert human operators placed directly at the production line, there are also some disadvantages. Besides being labor intensive, manual inspectors might evaluate the products slightly different, they are also by nature subjective, and their evaluations may be inconsistent so that they vary over time, even for the same expert (Little 1973). Therefore, alternative fast and objective control systems are desirable and it is not surprising that the development of fast nondestructive methods for food product quality monitoring is a rapidly evolving field. A few examples can be found in Jha et al. (2011), Telis-Romero et al. (2011), Liao et al. (2012), Oto et al. (2012), discussing such

Abstract

A method for characterization of butter cookie quality by assessing the surface browning and water content using multispectral images is presented. Based on evaluations of the browning of butter cookies, cookies were manually divided into groups. From this categorization, reference values were calculated for a statistical prediction model correlating multispectral images with a browning score. The browning score is calculated as a function of oven temperature and baking time. It is presented as a quadratic response surface. The investigated process window was the intervals 4–16 min and 160–200°C in a forced convection electrically heated oven. In addition to the browning score, a model for predicting the average water content based on the same images is presented. This shows how multispectral images of butter cookies may be used for the assessment of different quality parameters. Statistical analysis showed that the most significant wavelengths for browning predictions were in the interval 400–700 nm and the wavelengths significant for water prediction were primarily located in the near-infrared spectrum. The water prediction model was found to correctly estimate the average water content with an absolute error of 0.22%. From the images it was also possible to follow the browning and drying propagation from the cookie edge toward the center.

methods as UV spectra, electrical properties, ultrasound, and near-infrared (NIR) spectroscopy for online product quality assessment.

The surface color is one of the first impressions consumers get of a bakery product (Clydesdale 1991), giving the surface browning of cookies high importance as a quality parameter. The surface color of bakery products depends both on the physicochemical characteristics of the raw dough, such as water content, pH, reducing sugars, and amino acid content, and on the operating conditions during processing, mainly the final baking (Purlis 2011). During baking, the temperature, time, air velocity, and relative humidity can influence the browning of cookies.

Equally important, but harder to evaluate by online methods, is the water content of the cookie. If the water content is too high the shelf life of the product will be impaired (Manley and Clark 2011). During baking, water is transported through and away from the product. Evaporation takes place at the surfaces, and water migrates through the product toward the lower concentration at

the surface. A low water activity is a prerequisite for browning. While the water activity is not identical to the water content, as water activity is a measure of free water and water content is the total amount of water in the product, the two are closely related (Cauvain and Young 2000). For the purpose of this study, the water content has been used. To some extent, the water content might be deducted from the degree of browning; however, the opposite is not always the case, as a low water content can be obtained without browning at low surface temperatures (approximately below 115°C) (Broyart *et al.* 1998).

The purpose of this work was to investigate the use of multispectral image analysis to assess multiple quality aspects of bakery products from the same image. The investigated product is a butter cookie, and the investigated quality parameters are the surface browning and the water content after cooling. The developed browning score is based on sensory evaluation, distributing cookies in different browning categories. Combining surface browning with sensory evaluations, forming a single browning score, which is modeled as a function of the baking time and oven temperature has, to the knowledge of the authors, not been presented in previous academic papers. The ability to quantify the water content from the same multispectral images is furthermore investigated, showing that it is possible to assess different quality parameters from the same multispectral image and thereby saving time compared to the process of obtaining the information through visual observations or laboratory work.

In this work, the investigation is focused on the influence of baking time and oven temperature on browning and moisture content. A similar study of biscuits was presented in Carstensen (2012). In this work, a browning index was considered, along with the average water content. Additionally, a glazing index was obtained. The ability to predict the water content was found to be 0.14% root mean squared error of prediction (RMSEP) (see eq. 2). This study investigated industrially produced biscuits, limiting the investigated water content range to 1–3%. The browning index was built using endpoints, these being conforming and nonconforming areas of biscuits. A Fischer's discriminant analysis (FDA) was then used to map biscuits into a scale between these endpoints.

In the present work, a range of processing conditions (varying the time and temperature) were investigated. Compared to the study investigating biscuits produced in an industrial setting without variations, the present study investigates a broader window of applicability for the method. In the present work, the browning of the butter cookies ranged from underbaked to overbaked and the average water content ranged from 1.1% to 9.4%.

Materials and Methods

The present work is focused on two cookie data sets. The first set, Set 1, was prepared and used for sensory evaluation and model development with regard to the browning score. The second set, Set 2, was used to validate the browning model, build the browning response surface model, and to build and validate the water content model. The degree of browning was estimated on the second baking set, based on the model developed from Set 1. The water content was measured and estimated for Set 2. For water content evaluation, Set 2 was split into two groups, a modeling and an evaluation group. In the following, the baking procedure, the evaluation of browning, the method for water content measurements, the multispectral image capturing equipment, and the data processing methods are described.

Baking procedure

The examined butter cookies were prepared following the recipe in Table 1, provided by Haas-Meincke A/S¹ as an example of a typical industrial cookie product. The ingredients were mixed using a Varimixer Teddy (5L) mixer, (A/S Wodschow & Co., Broendby, Denmark) and rolled using a Rollmatic manual sheeter (Rollmatic Srl, Schio, Italy). The dough was rolled to a height of 6 mm (± 0.5 mm) and the cookies were cut to a diameter of 45 mm. The same cutter was used for all cookies. Between shaping and baking, the cookies were stored cool (5°C) and covered by plastic film to avoid dehydration of the surface. The cookies were baked in a Rational Combi CCC convection oven (Rational AG, Landsberg a. Lech, Germany).

The experimental part of the work was centered around the construction of two independent data sets. The first data set (Set 1) was created both as a training set for the multispectral imaging device and to be used in a sensory evaluation of the appearance of the cookies. Three cookies were used for imaging for each baking time. These images were used to create a browning score which indicates the stage of browning of a specific cookie. The cookies in this set were baked at a fixed temperature (180°C) varying the baking time to produce a range of browning.

The second data set (Set 2) was used to build a response surface describing how the time and temperature affects the browning score. The cookies for this set were baked at different oven temperatures and with varying baking times. Triplicates were made of all imaged cookies.

All cookies in Set 1 were baked at 180°C varying the baking time to obtain varied degrees of browning. The baking times were: 4, 6, 7, 8, 9, 10, 12, 14, 16, and

¹Haas Meincke A/S, www.haas.com.

Table 1. Composition and mixing procedure for 1.7 kg cookie dough.

Ingredients	Mass (g)
Icing sugar	333
Margarine	500
Vanilla extract	3.3
Mix until	Even texture
Whole egg	33.3
Skimmed milk powder	12.5
Salt	3.3
Sodium bicarbonate	0.4
Water	8.3
Mix until	Even texture
Corn starch	167
Wheat cake flour	667
Mix until an even	Textured dough is obtained
Finish by gathering	The dough by hand
Total weight	1728

20 min. Previous experiments by the authors had shown that the degree of browning moved from covering only the edge of the cookie to the whole surface at baking times between 6 and 9 min. Therefore, 1 min intervals were applied in this range.

The cookies in Set 1 were baked at different air temperatures (150, 160, 170, 180, and 200°C) and at different baking times (4, 6, 8, 10, 12, 14, and 16 min). These parameters were chosen to cover a wide range of surface browning.

Other parameters such as dough composition, product dimension, cooling time, and oven settings (air humidity and air speed) were kept constant for all baking experiments.

Evaluation of browning

In the current work, the goal was to link a sensory evaluation to a calculated browning score for the butter cookies. A panel consisting of six untrained persons was used to assess the degree of browning. In a production planning, a larger or trained panel might be used for a full-scale sensory analysis. In the present work, the objective of the analysis was to demonstrate a principle. Therefore, the smaller panel is well suited.

The panelists were in their mid-20s to mid-30s of Danish decent with a good knowledge of food production processes and food quality. The cookies from Set 1 were presented to the panel without information on the objectives of the study or the variations in baking times. Each panelist was asked to group the cookies into three categories, independently from the other members in the panel, using a form. The only criterion for separation was the appearance of the cookies with regard to browning. The

evaluation was done in a daylight setting. The panelists were asked to divide the cookies into the following three groups: *underbaked*, *adequately baked*, and *overbaked*. Each cookie could only be assigned to one category.

Water content

The water content was determined for Set 2. The average water content was found in the cookies after baking and cooling. The weight of the cookies was recorded before and after the cookies were placed in a drying cabinet at 105°C for 48 h (or until no further changes were registered in the weight). The mass loss during drying is assumed to be equal to the total water content in the baked cookie before drying. The final weight is seen as the dry matter (DM) content of the cookie.

In this work the water content is reported as the average water content or percentage of water per cookie. The fraction water per total cookie weight (X) is calculated as seen in equation (1):

$$X = \frac{m_{\text{water}}}{m_{\text{DM}} + m_{\text{water}}} = \frac{m_{\text{initial}} - m_{\text{dried}}}{m_{\text{initial}}} \quad (1)$$

where m is the weight of a given component in the cookie – either DM, water, or the initial or dried weight of the cookie.

VideometerLab

The imaging data was acquired using a VideometerLab (Carstensen *et al.* 2006). The VideometerLab captures multispectral images at 19 different wavelengths ranging from 385 to 970 nm. The system records the surface reflections with a standard monochrome charged coupled device chip, nested in a Point Grey Scorpion camera (Point Grey Research GmbH, Ludwigsburg, Germany). A schematic illustration of the whole setup is shown in Figure 1. The item of interest is placed inside a sphere with a matte white coating, an integrating or so called Ulbricht sphere. Inside the sphere light-emitting diodes (LED) are placed side by side in a pattern distributing the LEDs of each wavelength evenly across the whole perimeter to avoid shadows and specular reflections. During data acquisition, the diodes are strobing successively resulting in a 1280 × 960 image for each wavelength. Before data acquisition is commenced, the system is calibrated both radiometrically and geometrically followed by a light setup, to obtain the optimal dynamic range for all LEDs, as well as minimizing the distortions in the lens and thereby pixel correspondence across the spectral bands (Carstensen and Folm-Hansen 2003). The system is developed to guarantee the reproducibility of collected images,

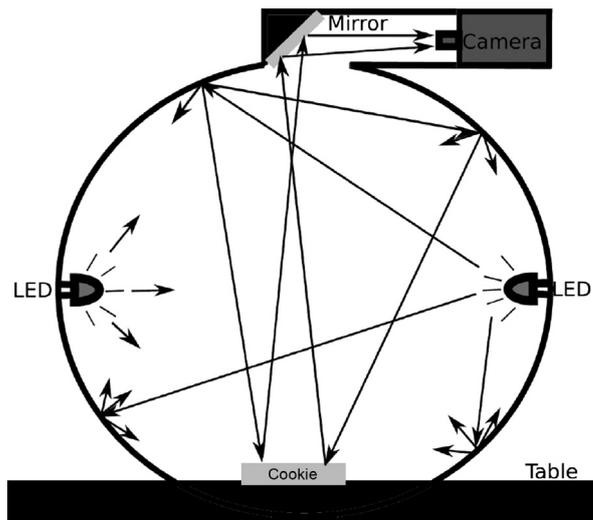

Figure 1. Schematic illustration of the Videometerlab setup showing the Ulbricht sphere, light-emitting diodes (LEDs), and camera positions (Dissing *et al.* 2011).

which means that it can be used in comparative studies of time series, or across a large variety of different samples.

In other recent studies, the VideometerLab setup was applied for quality studies of food products, as a fast method to quantify the amount of the red colored astaxanthin in salmonids (Dissing *et al.* 2011), to measure the degree of agglutination in continuously fried minced meat (Daugaard *et al.* 2010), and as a method to evaluate quality changes in stored wok fried vegetables (Clemmesen *et al.* 2012). According to the company Videometer A/S² the VideometerLab is currently implemented in industrial quality control lines including color sorting of mink furs (Kopenhagen Fur, Copenhagen, Denmark) and monitoring shape and texture distribution of bulk granule samples (Ferring International Center S.A., Saint-Prex, Switzerland).

Calculation of browning score

Multispectral images were treated to first remove the background, leaving only pixels with cookie surface. This was done using simple adaptive thresholding techniques. The browning score based on multispectral images and sensory evaluations is created using FDA (Hastie *et al.* 2001). The images in Set 1 were divided into categories by the sensory panel. Based on this division, the images were transformed to multivariable data matrices containing only pixel values from the surface of the cookies. The within-group and between-group scattering matrices used in the FDA were estimated based on all pixel values

across the cookie surfaces. Using the two scattering matrices, an optimal projection vector was found so that each group, when projected onto the vector, contracted so that the three groups were scattered as much as possible. In this way, the separation between the categories within the browning score space (which we call the space, in which the cookies are projected into) was maximized.

Estimating water content from images

In addition to the browning index, it was investigated whether the available NIR spectrum may be used to estimate the water content in the cookies. NIR imaging has in other studies proved to be a good method for estimation of water content in food products, such as minced meat (Dissing *et al.* 2009), breaded chicken nuggets (Yavari *et al.* 2011), and water-related qualities, such as drip loss (Barbin *et al.* 2012). Multispectral imaging is capable of detecting water shifts in the NIR area of the electromagnetic spectrum, disregarding the surface color. The brown color on the surface of the products is known to have high absorbance properties in the UV and visual areas (Kim and Lee 2009), which are well separated from the water peaks at 970, 1440, and 1930 nm.

To investigate the relation between the measured water content and the recorded spectra, a prediction model was created based on the mean spectra of cookies in Set 2, and the corresponding measured average water content (as given in eq. 1). A partial least squares regression (PLSR) was used to build the prediction model based on 2/3 of the available data, and tested on the remaining third of the data set (Wold *et al.* 2001). Parameters were estimated from a fivefold cross-validation scheme using the larger group of the data set. The accuracy of the model is given as the RMSEP, calculated as shown in equation (2) (Esbensen *et al.* 2002):

$$\text{RMSEP} = \sqrt{\frac{\sum_i^n (\hat{y}_i - y_i)^2}{n}} \quad (2)$$

where \hat{y}_i is the predicted average water content per cookie, y is the average measured water content, and n is the number of samples.

Results and Discussion

The results for the investigations of browning and moisture content are presented separately in the following sections. The first presented results are concerned with the browning and the browning model, the subsequent sections deal with the moisture content, the prediction model, and the results.

²www.videometer.com, 12 June 2012.

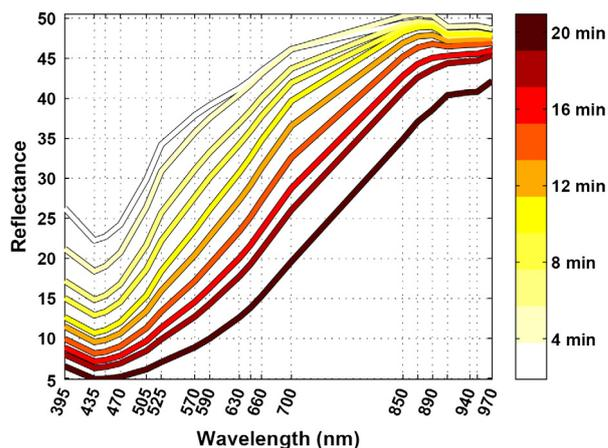

Figure 2. Spectra of training data. Each spectrum represents the mean spectral shape of all cookie pixels in a multispectral image. The shapes show a clear correlation with the baking time.

Multispectral images

A clear correlation was seen between the baking time and mean spectra for the cookies (Fig. 2). The spectra are plotted as spectral reflectance values as a function of wavelength; they are colored according to the baking time. Light colors denote short baking times, dark colors, long baking times. The reflectance of the spectra decreases with baking time. This indicates that the lightness of the cookies is decreasing. The reflectance differences are largest between 400 and 700 nm (the visible wavelengths), while they are smaller in the NIR area. Decreasing steps in reflectance are seen in the short wave (400–500 nm) end of the spectrum. It is known that melanoids, the brown components formed from the Maillard reactions, have absorption properties in this area, specifically at 420 nm (Kim and Lee 2009).

Browning evaluation and score

Results from the sensory evaluation of Set 1 are shown in Figure 3a. Cookies from each baking time were evaluated by each individual panelist; the evaluation shows that the adequate baking state is reached after 6 min.

The panel generally agreed that baking times lower than 6 min resulted in underbaked cookies. Cookies baked from 6 to 10 min were considered adequately baked; cookies baked for more than 1 min were considered overbaked. No cookies were evaluated as belonging to all three classes. Neither were any cookies evaluated as belonging to both the under and overbaked categories. This indicates a sufficiently clear separation between the categories for the purpose of this study. The clear separation is also seen in Figure 3b quantifying the browning

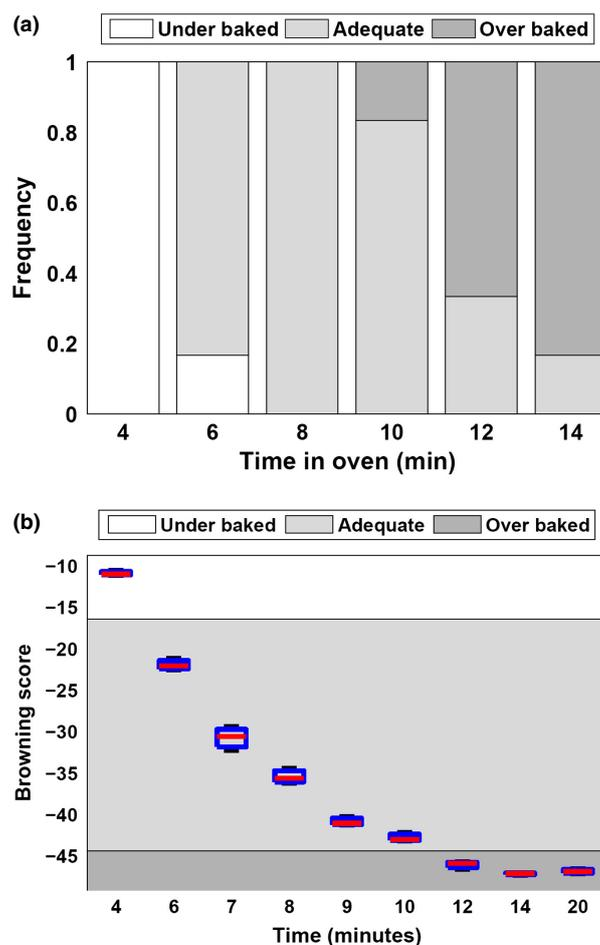

Figure 3. (a) Sensory evaluation. Each person classified a set of cookies into each of the stages underbaked, adequately baked, and overbaked. The histogram shows a normalized frequency for each group as a function of time in the oven. (b) Box-plot of mean values of browning score. Each box contains three samples. The background is shaded according to the classes defined by the sensory panel. The limits between the groups have been calculated as the mean euclidean distance between border boxes.

stages. In the figure a large gap between the extreme classes is shown as Euclidean distances based on the calculated browning scores. Figure 4 shows the two most significant projection vectors from the FDA.

The most significant wavelengths in the first loading are 395 and 525 nm, both of which are seen to contribute largely to the variance in Figure 2. Each box in Figure 3b contains mean score values of the cookies used to train the FDA model together with the mean score values of the two other repetitions. The spread of the values is relatively low, while the development over time shows a significant decrease in the overall browning score. The limits between the classes were calculated as the mean between the browning scores for 4 and 6 min baking, and

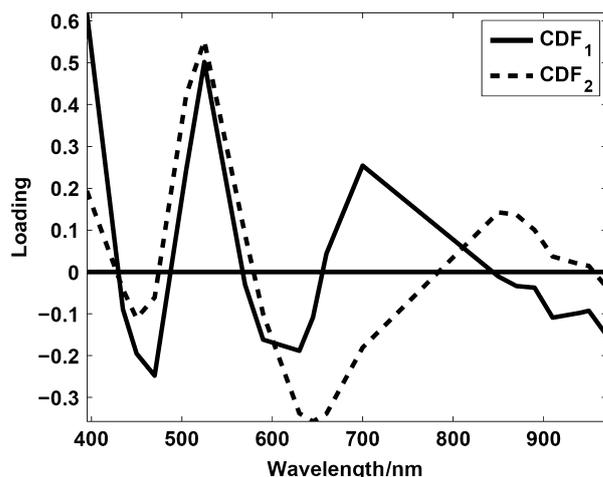

Figure 4. The loadings from the canonical discriminant analysis used to create the browning score. It is clearly seen how the area from 400 to 550 plays a significant role in the transformation vectors.

between 10 and 12 min. The browning score can be applied to multispectral recordings of new cookies to predict which stage of browning they are in. Examples are shown in Figure 5.

To check the uniformity of the browning on the surface of the cookies, pixel-wise browning scores were calculated. The result reveals how the browning propagates from the edge of the cookie toward the center during baking. Underbaked areas were only detected in cookies baked for 4 min; this corresponded well to the sensory evaluation. An overall browning score may be calculated for each cookie by taking the average of all the pixel-wise browning scores across the cookie.

The average browning scores were calculated for all cookies in Set 2 to assess the browning when varying both the baking time and the oven temperature. A quadratic surface was found to give the best description of the relation between browning and both oven temperature and baking time, without overfitting the data. Equation (3) was fitted to the browning scores, where x_1 is the time (min) and x_2 is the temperature ($^{\circ}\text{C}$). The browning score value is 0 for no browning at the surface and decreases with increasing browning as shown in Figure 6.

$$y = 0.32 - 0.12x_1[\text{min}^{-1}] - 0.13x_2[{}^{\circ}\text{C}^{-1}] + 0.008x_1x_2[(\text{min} \cdot {}^{\circ}\text{C})^{-1}] + 0.02x_1^2[\text{min}^{-2}] + 0.02x_2^2[{}^{\circ}\text{C}^{-2}] \quad (3)$$

From the response surface, it is seen that a 1 min increase of the baking time will have approximately the same effect as increasing the baking temperature with 10°C . The results are valid within the investigated range

of temperatures ($150\text{--}200^{\circ}\text{C}$) and baking times (4–16 min), using the setup described in the Materials and Methods section. For other processes, new models should be developed, as the process equipment and setup influence the browning development strongly. The maximum baking time in the response surface was set to 16 min. Cookies were baked for longer baking times; up to 0 min, these are considered as extreme cases and are therefore not included in this part of the study.

Determining water content

A total of 99 cookies were used for building and evaluating the model for average water content. Based on the 18 spectra obtained for each cookie surface, a mean value was calculated. A principal components analysis, which reveals the primary latent variance in the extracted features, is shown in Figure 7a. Each dot is a score value representing a cookie, color coded by its water content. Especially, PC 1 provides a good description of the development in the average water content. This variation was related to the measured water content using a partial least squares regression model. In order to build the model, 66 cookies were selected randomly and used in a fivefold cross-validation scheme for parameter estimation. Using the spectral means for training the model, PLSR components were calculated. From the model, the water content in the remaining 33 cookies was predicted. A plot of the predicted versus the measured values for both the training and the test cookies is seen in Figure 7b. This shows a very good approximation. Summing all the residuals, a RMSEP of 0.16% is obtained for the training set and 0.22% is obtained for the test set. The range of average water content in the data set spans from 1.13% to 9.39% (kg water per kg cookie). As expected, loadings from the model revealed that the short wave NIR area of the electromagnetic spectrum was highly correlated with the measured water content. The spatial distribution of water on the surface of each cookie was assessed by projecting each recorded spectrum of the cookie surface (one per pixel) with the calculated model. Figure 8 shows the spatial predictions on cookies baked at 150°C at different baking times. In Table 2, measurements and predicted values for the water content are shown for cookies baked at an oven temperature of 150°C and different baking times.

Conclusion

The used vision system records multispectral images in the visible and the first part of the NIR areas of the electromagnetic spectrum. An acceptance score was developed using FDA, based on the evaluation of cookies by a

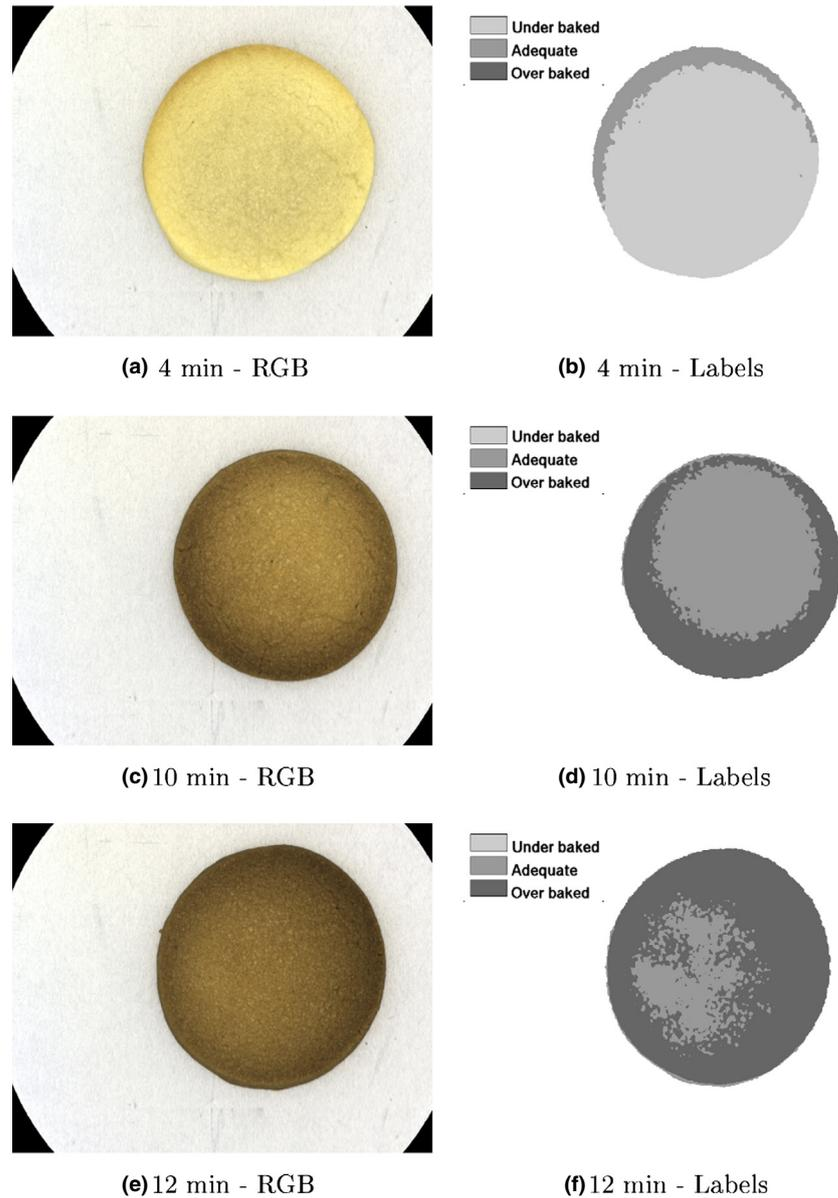

Figure 5. Pseudo-RGB representations of the multispectral images of cookies taken at different baking times. For each RGB image, a classified image is shown where pixels have been classified to one of the three browning stages. The predicted images were smoothed with a Gaussian filter before thresholding in order to remove noise. When observing the images from the top and down it is seen how the browning of the cookies starts from the edges and progress toward the center. Only the first cookie (4 min) contains areas of underbaked surface.

sensory panel. According to the sensory panel, cookies baked for 4 min were *underbaked*, while cookies baked for 6–10 min were *adequately baked*; longer baking times resulted in *overbaked* cookies. This evaluation was purely based on the visual appearance of the cookies, thus by the color and visual perception of texture.

The discriminant analysis revealed that the main wavelengths when creating the acceptance score were 395 and 525 nm, corresponding very well to the absorption properties of melanoids. From the acceptance score, a

response surface was created, building a model which relates the influence of time and temperature to browning. The change in surface browning was comparable when changing the baking time with 1 min or the oven temperature with 10°C. A broad acceptance band was found, corresponding well to the sensory evaluations. A demonstration of the browning distribution on the surface of the cookies was presented showing how the browning starts from the edges of the cookie and works its way toward the center.

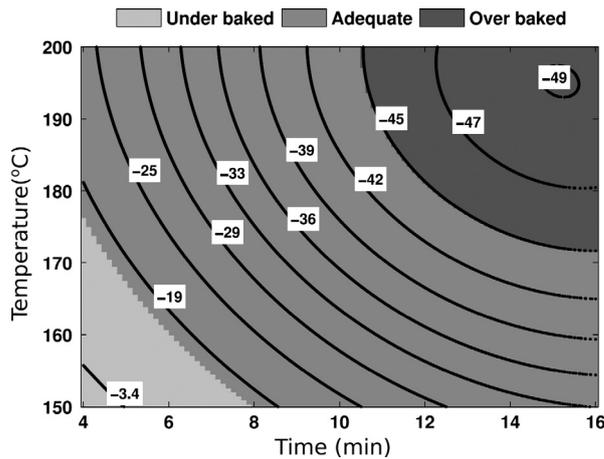

Figure 6. The surface browning score as a function of time and temperature for butter cookies. The zones indicate areas created by the sensory evaluation, corresponding to underbaked, adequately baked, and overbaked appearance.

Table 2. Average real and predicted water content for the cookies the surfaces of which are shown in Figure 8. The real values have been measured using a drying cabinet while the predicted values were calculated as average values of all pixels on the surface.

Time (min)	Temperature (°C)	Measured (%)	Predicted (%)	Deviation
4	150	9.17	9.18	0.01
6	150	6.40	6.30	-0.10
8	150	4.72	4.44	-0.28
10	150	3.57	3.60	0.03
12	150	2.38	2.75	0.37
14	150	2.07	2.24	0.17

Besides assessing the surface browning, the water content in the cookies was evaluated. An approach similar to that of the acceptance score was used. The loading vector revealed that in order to map spectra to water content, the NIR area was of most importance. Having the NIR area in a water prediction model was expected due to the

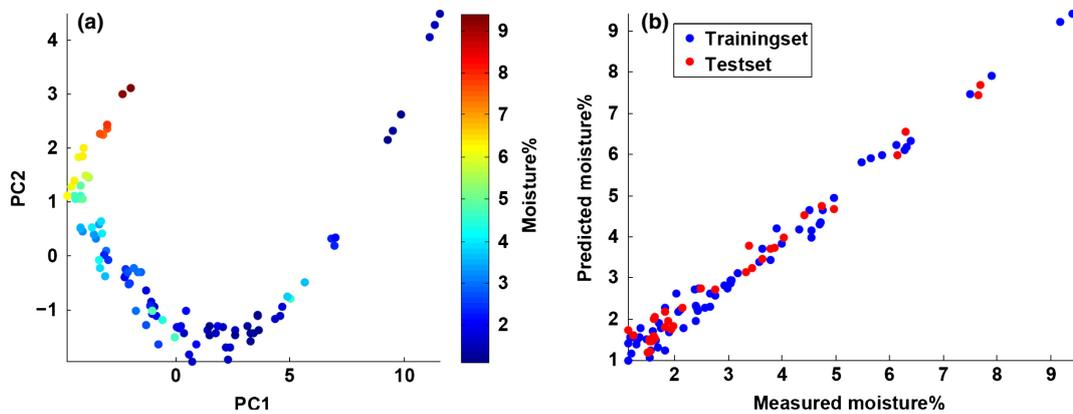

Figure 7. (a) Loadings of the water prediction model. The near-infrared area shows significant peaks together with the area around 470 nm. (b) Values of standard error of prediction calculated in a bootstrap procedure. The average of the squared error of prediction (SEP) values is calculated to 13.6, meaning that on average the prediction method has an error rate of 13.6%.

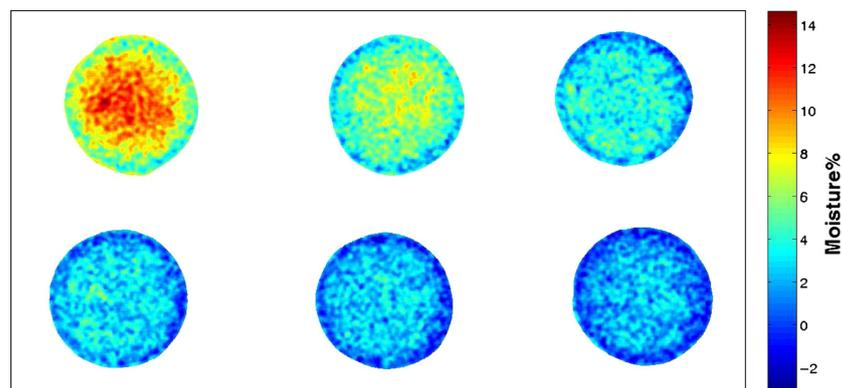

Figure 8. Water content for five cookies has been predicted for each pixel on the cookie surface and smoothed to remove noise. The average water prediction for the five cookies has been calculated and presented in Table 2. The color map used in the visualization of the five surfaces is the same where blue values correspond to low water content and red values correspond to high water content.

water peak around 970 nm. The water content was well estimated with a RMSEP of 0.22%.

It was shown that it is possible to use multispectral imaging to assess both the browning and the water content of butter cookies. Furthermore, the method was used to evaluate the browning and water content across the cookies surface, giving an indication of the evenness of the process and the produced products. In a production setting, only the relevant wavelengths would be used for monitoring, making image capturing and the following data processing possible during online production.

Acknowledgments

The authors thank the Danish Ministry of Food, Agriculture and Fisheries for grants supporting this research (J.no. 3414-08-02280 and J.no. 3304-FVFP-06066001).

Conflict of Interest

None declared.

References

- Barbin, D. F., G. ElMasry, D.-W. Sun, and P. Allen. 2012. Predicting quality and sensory attributes of pork using near-infrared hyperspectral imaging. *Anal. Chim. Acta* 719:30–42.
- Broyart, B., G. Trystram, and A. Duquenoy. 1998. Predicting color kinetics during cracker baking. *J. Food Eng.* 35:351–368.
- Carstensen, J. 2012. Biscuit quality assessment by spectral imaging *in* Proceedings of the Third Annual Hyperspectral Imaging Conference, Istituto Nazionale di Geofisica e Vulcanologia, Rome, Italy.
- Carstensen, J. M., and J. Folm-Hansen. 2000. An apparatus and a method of recording an image of an object. European Patent EP1051660. Granted Nov. 2003.
- Carstensen, J. M., M. E. Hansen, N. K. Lassen, and P. W. Hansen. 2006. Creating surface chemistry maps using multispectral vision technology. Pp. 19–28 *in* Proceedings of the MICCAI (Medical Image Computing and Computer Aided Intervention) 2006 workshop on biophotonics imaging, 6 October, Copenhagen. ISBN 87-643-0116-8.
- Cauvain, S. P., and L. S. Young. 2000. Bakery food manufacture and quality – water control and effects. Blackwell Science Ltd., Oxford, U.K.
- Clemmesen, L. H., B. S. Dissing, G. Hyldig, and H. Løje. 2012. Multispectral imaging of wok-fried vegetables. *J. Imaging Sci. Technol.* 56:20404-1-6.
- Clydesdale, F. M. 1991. Color perception and food quality. *J. Food Qual.* 14:61–74.
- Daugaard, S. B., J. Adler-Nissen, and J. M. Carstensen. 2010. New vision technology for multidimensional quality monitoring of continuous frying of meat. *Food Control* 1:626–632.
- Dissing, B. S., B. K. Ersbøll, and J. Adler-Nissen. 2009. Monitoring water content using multispectral imaging and NIR in minced meat *in* Abstract from 14th International Conference on Near Infrared Spectroscopy (NIR 2009), Bangkok, Thailand.
- Dissing, B. S., M. E. Nielsen, B. K. Ersbøll, and S. Frosch. 2011. Multispectral imaging for determination of astaxanthin concentration in salmonids. *PLoS One* 6:e19032.
- Esbensen, K., D. Guyot, F. Westad, and L. Houmøller. 2002. Multivariate data analysis in practice: an introduction to multivariate data analysis and experimental design. Camo Process AS, Oslo, Norway.
- Hastie, T., R. Tibshirani, and J. Friedman. 2001. Elements of statistical learning: data mining inference and prediction. 2nd ed. Springer, Berlin, Germany.
- Jha, S. N., K. Narsaiah, A. L. Basediya, R. Sharma, P. Jaiswal, R. Kumar, et al. 2011. Measurement techniques and application of electrical properties for nondestructive quality evaluation of foods: a review. *J. Food Sci. Technol.* 48: 387–411.
- Kim, J.-S., and Y.-S. Lee. 2009. Enolization and racemization reactions of glucose and fructose on heating with amino-acid enantiomers and the formation of melanoidins as a result of the Maillard reaction. *Amino Acids* 36:465–474.
- Liao, Y., Y. Fan, and F. Cheng. 2012. On-line prediction of pH values in fresh pork using visible/near-infrared spectroscopy with wavelet de-noising and variable selection methods. *J. Food Eng.* 109:668–675.
- Little, A. C. 1973. Color evaluation of foods, correlation of objective facts with subjective impressions. Pp. 109–127 *in* Sensory valuation of appearance of materials: a symposium, Issue 545. American Society for Testing and Materials, West Conshohocken, PA.
- Manley, D., and H. Clark. 2011. Secondary processing of biscuits. Pp. 511–546 *in* D. Manley, ed. *Manley's technology of biscuits, crackers and cookies*, Ch. 41. 4th ed. Woodhead Publishing Limited, Cambridge.
- Oto, N., S. Oshita, S. Kawagishi, Y. Makino, Y. Kawagoe, M. Al-Haq, et al. 2012. Non-destructive estimation of ATP contents and plate count on pork meat surface by UV-Vis reflectance spectrum analysis. *J. Food Eng.* 110:9–17.
- Purlis, E. 2011. Bread baking: technological considerations based on process modelling and simulation. *J. Food Eng.* 103:92–102.
- Telis-Romero, J., H. Vaquiro, J. Bon, and J. Benedito. 2011. Ultrasonic assessment of fresh cheese composition. *J. Food Eng.* 103:137–146.
- Wold, S., M. Sjöström, and L. Eriksson. 2001. PLS-regression: a basic tool of chemometrics. *Chemometr. Intell. Lab. Syst.* 58:109–130.
- Yavari, A., A. Heshmati, M. Hamed, and S. Haghbin. 2011. VIS/NIR hyper-spectroscopy technique for the measurement of moisture and fat contents of breaded-fried chicken nuggets. *Food Chem.* 127:645–650.

Appendix B

Abstract and poster: A mechanistic approach to baking process-product interactions

This appendix contains an abstract and corresponding poster “*A mechanistic approach to baking process-product interactions*” presented at the 2010 Food Factory conference, Gothenburg, Sweden.

Recipe for the bread rolls:

Table B.1: *Ingredients for bread rolls based on 1 kg of flour.*

Ingredients	Mass (g)
Flour	1000
Water	550
Salt	16
Sugar	16
Oil	16
Dry yeast	12

The ingredients are shown in Table B.1. Water, oil, salt, sugar and dry yeast were mixed until the dry yeast was dissolved. The flour was added to the dough. Before shaping the dough was left to rise for 35 min. Each bread roll was shaped from 100 g of dough. Before baking the bread rolls were proved in a cabinet with increased humidity at approximately 35°C for 45min. Six bread rolls were baked at two different oven settings for a total of 20 min. The used oven was a Rational CCC Combisteamer, Rational, Germany.

A Mechanistic Approach to Baking Process-Product Interactions

Name(s) and Affiliation (s):

M. Stenby¹, Jens Adler-Nissen¹, Søren Skovlund².

¹National Food Institute, Food Production Engineering, Technical University of Denmark

²DFE Meincke

e-mail: metst@food.dtu.dk

Bread baking is a highly energy demanding process. Besides heating the product, a large fraction of the energy is used to heat the oven and is lost to the surroundings. A way to minimize this fraction is a better understanding of the mechanisms behind the physical changes arising from the process-product interactions. Complex heat and mass transfer equations exist, but are not easily applicable when planning a production.

The goal of this work has been to formulate a mechanistic model describing what is happening in the dough and bread during the baking process, and additionally the significance of changes in chosen physical parameters (air velocity, humidity, temperature) near the product.

Experiments have shown that as a first approximation the process can be divided into two separate steps. First the dough is heated and expands. After some time the crumb temperature reaches a uniform temperature of 100°C, due to the high porosity and rapid heat transfer from evaporation and condensation of water. At this point the crust formation and coloration is initiated as the surface starts to dry. During crust formation the surroundings can be considered as constant with the oven conditions on the outside and the crumb structure at 100°C on the inside. The crust will thicken as water is transported from the crumb to the surface and evaporates. These findings indicate that it might be possible to implement alternative heating methods to focus the initial heating of the dough, and thus shorten the total process time. The extent to which the crust quality is affected by the initial process parameters is yet to be finally determined through model validation.

An important step towards validation of the mechanistic model has been taken as a special prototype oven is currently under construction. The new oven is a batch oven build to simulate continuous baking processes. This is done by enabling fast changing of baking temperature (up and down), controlled air velocity and flow pattern, and the possibility of quick changes between radiative and convective heating. Furthermore, the oven is designed so that general information can be obtained about baking. This is done by continuous measurements of the product weight, and the chamber humidity; sensors can easily be connected for temperature measurements, and windows and mirrors are installed so that the product can be followed visually throughout the processing.

A Mechanistic Approach to Baking Processes

The Initial Oven Temperature

Mette Stenby^{1*}, Jens Adler-Nissen¹, Søren Skovlund²

¹National Food Institute, Food Production Engineering, Technical University of Denmark. ²DFE Meincke A/S.

*Contact: metst@food.dtu.dk

Abstract Our approach is to evaluate the baking processes step-wise and link the physical changes in the bread to the surrounding physical parameters (air velocity, humidity, temperature). This is a step-by-step way to minimize energy consumption and optimize the process parameters during baking. In the following considerations for the first step are described.

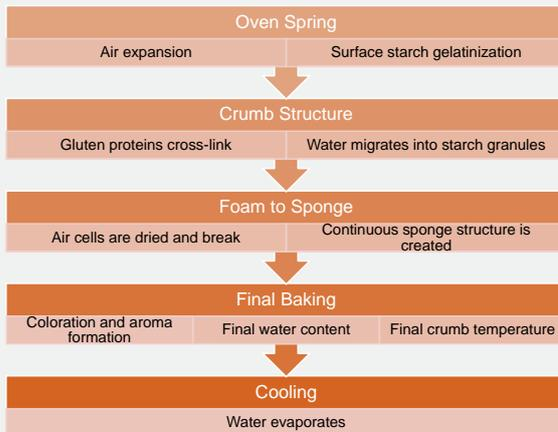

Figure 1. Steps and changes during the baking process.

Hypothesis – The Initial Baking Process

An overview of the baking process is given in Figure 1. Traditionally the baking process starts at a high temperature (typically 220-240°C) during the first period of baking. This is combined with addition of vapor. The vapor is added to obtain a shiny crust, as it condenses on the oven air temperature resulting in starch gelatinization.

As long as water condenses on the surface, the surface temperature will not exceed 100°C. This indicates that the temperature difference between the surface and the center of the bread does not depend on the oven air temperature in the initial baking phase.

The tested hypothesis is: *lowering of the temperature during the initial baking step will not influence the final baking result.* Validation of this theory could lead to water and energy savings in the baking industry. The hypothesis is tested by comparing the temperature profiles near the crumb center and the volume of the bread rolls.

Experimental Set-up

Two set-ups with different initial temperatures were tested. The oven settings are shown in Table 1, the initial temperatures differed by 80°C and were both 40°C from the final baking temperature. The vapor addition was at a high setting in the used Rational Combi-steamer. The temperature was measured with T-type thermocouples in the bread rolls. Six bread rolls were used for each method. A French bread type was used as the model product, the dough recipe can be found in [1].

Table 1. The oven settings in the two tested baking processes.

Process	First 3 min	Last 17 min
High Initial Oven Temperature	220°C + vapor	180°C
Low Initial Oven Temperature	140°C + vapor	180°C

References:

- [1] Skjöldebrand, C. & Andersson, C., 1989. A Comparison of Infrared bread Baking and Conventional Baking. *Journal of Microwave Power and Electromagnetic Energy*, 24 (2), pp.91-101.
 [2] Wiggins, C. & Cauvain, S. P., 2007. Proving, Baking and Cooling. In: Cauvain, S. P & Young, L. S., 2007. *Technology of Bread Making*. USA: Springer Science + Business Media. Ch. 5.

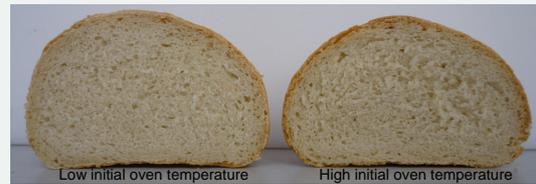

Figure 2. Comparison of the crumb structure for the two baking processes.

Results

Crumb and Volume

The pictures in Figure 2 show the crumb structures for the two baking procedures. The crumbs are baked through in both cases and the air bubble structures are comparable. The volumes of the bread rolls were not significantly different (mean±SD): 199±16cm³ and 194±23cm³ for low and high initial oven temperatures, respectively.

Temperature Profiles

The average values for the temperature measurements can be seen in the graph (Figure 3). The standard deviations are shown for the crumb temperatures. The time needed to reach 95°C [2] is used as a comparison between the baking processes, as the crumb will be baked through at this temperature. The time needed to reach 95°C is not significantly different for the two methods. This is also clear from the graph where both average curves are within one standard deviation of each other throughout the baking process.

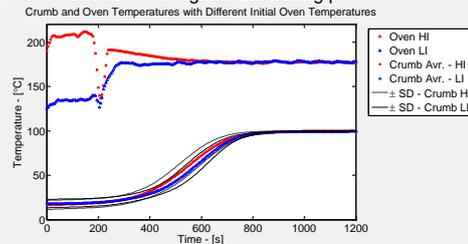

Figure 3. Average oven and crumb temperatures during baking. HI = high initial oven temperature, LI = low initial oven temperature. The average crumb temperatures are shown ± one standard deviation (n=6).

Table 2. The average times needed to reach 95°C ± one standard deviation.

Process	Time to reach 95°C (s)
High Initial Oven Temperature	759 ± 46
Low Initial Oven Temperature	769 ± 31

Conclusion and Perspectives

The results show that the temperature profile for the crumb is not significantly affected by the initial oven temperature when vapor is added. These results indicate that energy can be saved by lowering the oven temperature during the first step of baking when vapor is used. The next step will be to use a more controlled system, and then look at additional quality parameters such as the crust formation.

Appendix C

Poster: Design and construction of a batch oven for investigation of industrial continuous baking processes

This appendix contains the poster “*Design and construction of a batch oven for investigation of industrial continuous baking processes*”, presented at the International Congress on Engineering and Food, Athens, Greece, May 2011.

Batch Oven for Investigation of Industrial Continuous Baking Processes

Mette Stenby¹, Brian Nielsen², Jørgen Risum¹

¹National Food Institute, Technical University of Denmark, Kgs. Lyngby, Denmark (metst@food.dtu.dk), ² Haas-Meincke A/S, Skovlunde, Denmark.

Abstract

A new convection batch oven has been constructed to simulate baking as in industrial continuous tunnel ovens. In the oven, the following parameters can be controlled: The air temperature, the air humidity, and the air velocity. To enhance modelling work the following data is logged continuously: The oven chamber temperature, the product temperature, the product weight, and the air humidity. Moreover, the product can be inspected visually through a window. Baking experiments have shown good resemblance to cookies baked in a tunnel oven. Validation of the oven's evenness of baking, using cookie browning, air velocity, and heat transfer coefficients as markers, show a good ability to bake uniformly.

Background

As part of an ongoing research project, investigating the influence of oven settings on baking product quality, a unique experimental batch oven has been built to mimic the environment in tunnel ovens. The oven, the baking chamber, and a schematic of the convective system are shown in Figure 1.

Control and Data Collection

To simulate continuous ovens, the following parameters are controlled: Air temperature, air humidity, and the distribution between top and bottom air inlets. For modelling purposes the following is logged continuously during baking: The air temperature by the product, the air humidity, and the product weight. Additionally a window is installed to monitor the product visually throughout baking.

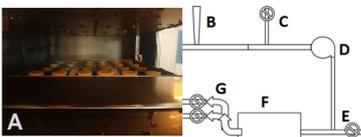

Figure 1. Left: Exterior pictures of the oven. Right: Overview of the air exchange system. A) The baking area in the chamber, seen through the window. B) Humidity sensor. C) Fresh air intake. D) Ventilator. E) Air exhaust. F) Heating element. G) Top/Bottom inlet air.

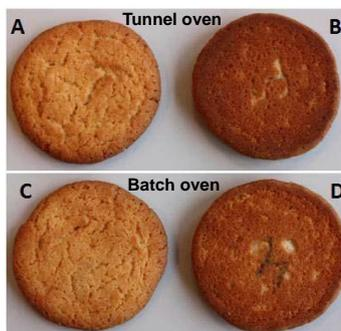

Figure 2. Cookies baked for comparison of the batch and a tunnel oven, using similar oven settings. Tunnel oven (A+B). Batch oven (C+D).

Experimental work

Comparing with a Tunnel Oven

Comparisons were made with cookies baked in a 10m tunnel oven, using the same temperature and air velocities. Comparisons were made for: The mass loss, the dry matter content, and the lightness (Table 1). The only difference was a slightly darker colour on the bottom of the cookies baked in the tunnel oven (Figure 2). This is most likely due to the pre-heating of the baking band in the tunnel oven.

Uniformity Across the Baking Tray

The uniformity across the baking area was tested at the same settings as the comparative baking tests. The investigated markers were: Inlet air velocity, heat transfer coefficients, and cookie browning.

Results for the velocities and heat transfer coefficients measurements are shown in Table 2. Cookies, and heat transfer coefficients found in the same positions, are shown in Figure 3. No significant variations were seen for the velocities or the browning. Dividing the baking tray into 6 groups of 4 cookies (2x2), showed a significant difference for the upper right group compared to the rest of the baking area. The effect and nature of the difference will be further investigated.

Conclusion

A new unique batch oven has been constructed to help modeling industrial tunnel ovens. This is possible due to the extensive monitoring during baking. Experiments have shown that it is possible to reproduce cookies baked in a tunnel oven. Uniformity of baking conditions across the baking area was investigated. Both inlet air velocities and browning was seen to be uniform. A small variation was found for the heat transfer coefficients. This did not show on the degree of browning, but will be examined further.

Table 1. Overview of the comparison between tunnel and batch baked cookies.

Oven type	Tunnel	Batch
Initial dough weight (g) ¹	22 ± 0.7	21 ± 0.5
Baking loss (%) ¹	12 ± 0.4	12 ± 0.4
Final dry matter content after cooling (%) ²	96 ± 0.5	96 ± 0.1
Lightness (L*) top surface ³	59 ± 1.4	59 ± 2.2
Lightness (L*) bottom surface ⁴	41 ± 1.1	48 ± 3.1

¹All cookies (n = 6). ² 2 from each group (n = 2). ³ Three measurements on each cookie (n = 18). ⁴ One measurement on each cookie (n = 6).

Table 2. Results of investigation of the variations for the inlets and the baking area.

Tested quality	Average
Velocity (36 holes) ¹ – top (m/s)	3.3 ± 0.2
Velocity (36 holes) ¹ – bottom (m/s)	2.2 ± 0.2
Heat transfer coefficient ² (W/(m ² ·K))	62 ± 3.8

¹The velocity at the inlet holes was measured twice, all measurements are used when calculating the average (n=72). ² The heat transfer was measured in 24 position on the baking tray.



Figure 3. Calculated heat transfer coefficients (W/(m²·K)), determined at the positions of the cookies baked to test the uniformity of browning.

Appendix D

Article: Design and construction of a batch oven for investigation of industrial continuous baking processes

This appendix contains the article “*Design and construction of a batch oven for investigation of industrial continuous baking processes*”, accepted for publication in *Journal of Food Process Engineering* on January 17th, 2013. An early-view version published online on April 17, 2013 is included.

DESIGN AND CONSTRUCTION OF A BATCH OVEN FOR INVESTIGATION OF INDUSTRIAL CONTINUOUS BAKING PROCESSES

METTE STENBY ANDRESEN¹, JØRGEN RISUM and JENS ADLER-NISSEN

Division of Industrial Food Research, National Food Institute, Technical University of Denmark (DTU), Søtoftsplads 227, Kongens Lyngby 2800, Denmark

¹Corresponding author. TEL: +4545257516; FAX: 4593-9600; Email: metst@food.dtu.dk

Received for Publication April 10, 2012
Accepted for Publication January 17, 2013

doi:10.1111/jfpe.12012

ABSTRACT

A new batch oven has been constructed to mimic industrial convection tunnel ovens for research and development of continuous baking processes. The process parameters (air flow, air temperature, air humidity, height of baking area and the baking band velocity) are therefore highly controllable and adjustable over a wide range of settings. It is possible to monitor the product weight and temperature continuously during baking. The simultaneous measuring of mass and a window allowing for visual (e.g., by video recording) control is unique for this experimental batch oven. Two validation steps have been carried out. The uniformity of heating in the oven was assessed by measurements of local heat transfer coefficients and confirmed by baking tests. The methods showed that the oven is able to heat and bake uniformly across the baking area. Hereafter, the oven was validated against a commercial 10-m tunnel oven, with a butter cookie as the test product. The investigated quality parameters for the butter cookies were mass loss and surface browning, where the uniformity of browning was evaluated subjectively against a scale of standards and objectively by L^* value measurements. Good reproducibility of the baking was documented over a range of temperatures (160C to 190C).

PRACTICAL APPLICATIONS

The purpose of this paper is to describe a new specially designed pilot scale batch oven. The batch oven is designed and constructed to imitate the baking processes in continuous tunnel ovens with forced convection. Experimental work in the new batch oven will increase knowledge of how the environment and baking conditions influence the quality of bakery products in continuous tunnel ovens.

INTRODUCTION

Industrial baking in large scale is often carried out in continuous multi-zone tunnel ovens. The division of the oven chamber into different zones, which can be regulated independently, makes it possible to expose the products to different baking conditions while they move through the oven. Compared to baking in a batch oven, the multi-zone tunnel oven gives more freedom for optimizing and controlling the baking process (Baik 2000b; Mirade *et al.* 2004). This optimization is traditionally performed by trial and error, as trained operators use their experience adjusting the process parameters to achieve the desired quality and productivity

(Manley 2000). This dependency on empirical and often tacit knowledge of the baking process is not an ideal basis for a rational optimization of processes and equipment.

For both oven manufactures and industrial bakeries, there is a need to gain more systematic knowledge on the impact of the physical conditions in tunnel ovens on both process mechanisms and product quality. While many studies have focused on the influence of recipe formulation on product quality, a few recent examples are changing the flour type from wheat to barley (Frost *et al.* 2011), using pectin as fat replacements (Min *et al.* 2010) and evaluating the overall impact of the sugar and fat contents (Pareyt *et al.* 2009), less work has been published regarding the impact of

the process conditions on the product quality in continuous baking processes.

The baking conditions in industrial tunnel ovens are considerably different from standard batch ovens. Tunnel ovens either heated directly or by radiation often have varying temperature profiles through the oven chamber, while the temperature is kept constant in most batch oven processes (Baik 2000b). In convection-heated tunnel ovens, the air flow pattern is very different from that of a convection batch oven for professional use. Standard professional batch ovens have the heating element inside the oven chamber where the air is circulated by ventilators creating an air flow horizontally across the products from one side. Tunnel ovens have a separate heating unit from which hot air is led through air ducts into the baking chamber. The air ducts are situated above and below the moving baking band. The air moves down, across the product and out through exhausts placed along the sides of the upper air ducts. In this way, a uniform down- and sideways air flow is created over the products as they move through the oven.

In collaboration with a leading manufacturer of industrial tunnel ovens, Haas-Meincke A/S, Denmark, the authors are engaged in a joint research project, which aims at increasing the quantitative knowledge of tunnel oven baking processes. The overall scope of the project is to develop robust product-process models for baking in convective tunnel ovens, in this way, enabling prediction of product quality variations based on changes in the process conditions. A crucial step in this work is to construct a specially designed experimental pilot scale batch oven. The special batch oven described in this work is build with three main objectives:

- (1) The new oven must be constructed so that the environment inside the oven chamber emulates that found in continuous tunnel ovens.
- (2) The oven is designed for research purposes and should therefore allow for continuous recording of the product response to the process conditions. The main product properties followed during baking, the mass loss and visual changes such as color formation. Normally, such measurements are impossible to perform continuously in an industrial tunnel oven (Manley 2000), which is a significant obstacle to systematic studies of continuous baking processes.
- (3) The third important purpose of the new oven will be to conduct experiments in which the oven conditions are outside normal standard settings. For example, baking at higher or lower temperatures, pulsating air velocities or varying air humidity can be examined. This is needed in order to investigate options for future optimizations.

Several types of continuous ovens are commercially available and used in the bakery industry, differing with regard to the heating type, the heating method and the

overall chamber design. The target oven type in this work is indirectly fired convection-based tunnel ovens, and the experimental batch oven is therefore designed to reproduce conditions found in such ovens. Data for process monitoring and control is acquired from temperature sensors and a humidity sensor at relevant positions in the oven chamber and air duct system. Additionally, the product weight is followed continuously during baking. The changes in dimensions and appearance (color) can be inspected visually or recorded by photography through a window in the side of the oven chamber.

To the authors' knowledge, only two batch ovens have so far been constructed with the specific goal of investigating continuous tunnel ovens (Sommier *et al.* 2005; Zareifard *et al.* 2006). The oven described by Zareifard *et al.* (2006) is designed to reproduce industrial baking processes. Among other things, it has been used to investigate the influence of the relation between radiative and convective heating while keeping the total heat flux constant (Zareifard *et al.* 2009). The oven shows good reproductions of industrially baked products. However, the baking chamber does not allow for the same product monitoring during baking as this new experimental batch oven. The other pilot scale oven for investigation of continuous baking processes (Sommier *et al.* 2005) is more similar to the present described batch oven. This oven enables extensive continuous monitoring of the process and product including temperatures, product weight, visual recoding of the product and humidity measurements. The main difference between the oven described by (Sommier *et al.* 2005) and the pilot batch oven described in this work is the design of the convective system. The oven described by (Sommier *et al.* 2005) is a modified conventional batch oven, while the new oven is specially designed to have an air flow pattern similar to that found in continuous tunnel ovens. As discussed, the air flow pattern in a tunnel oven is distinctly different from that of a conventional batch oven for professional use.

For the new batch oven, baking trays of 0.45×0.45 m are used, which are significantly smaller than the 1.27×1.17 m baking areas described in (Zareifard *et al.* 2006). The smaller area does limit the number of products per batch; however, it enables weight recording during baking. Furthermore, the small baking chamber, combined with the specially designed inlet air system has proven to provide even baking and good flexibility for process parameter variations.

MATERIALS AND METHODS

Design of the Batch Oven

The investigated type of industrial ovens are multi-zone, convective, indirectly fired tunnel ovens. A schematic illus-

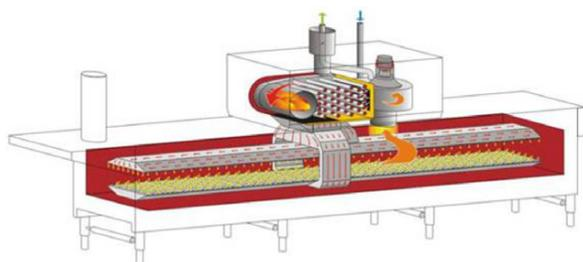

FIG. 1. A SCHEMATIC OF AN INDIRECTLY FIRED CONVECTIVE TUNNEL OVEN (ONE ZONE IS SHOWN IN THE FIGURE)

The baking band is not included in the figure. It would be situated at an appropriate distance between the two inlet air ducts. The wide (orange) arrow show the exhaust and recirculation system for the air (Haas-Meincke A/S ©).

tration of one zone from the oven type in question is seen in Fig. 1. The length varies from 10 m up to over 100 m, and the width of the baking band range from 0.8 to 4.2 m. The ovens are built of consecutive zones, each having its own heating unit. The length of a zone normally varies from 6 to 16 m. The temperature, the inlet air distribution (top : bottom) and the air humidity can be controlled independently for each zone.

In the investigated type of oven, the rate of air exchange is fixed at 8,000 m³/h/zone. In order to obtain a uniform air flow and heating pattern, the manufacturer, Haas-Meincke A/S, has designed the ovens with perforated air ducts above and below the product, parallel to the baking band, each with 700 inlet nozzles per zone. The diameter of the nozzles is 13 mm, resulting in an average linear velocity of 12 m/s when the volumetric air flow is divided by the total inlet area. At this velocity, the Reynolds number is $\approx 4,700$ for the air flow through the nozzles giving a turbulent flow (Sarkar *et al.* 2004). Air jets, like the ones in the oven, are impinging jets as they are focused on a solid surface. This kind of jet can be divided into three regions, a free jet region in which the air jet is behaving as a free jet, a stagnant zone, where the jet meets the surface and a radial spread zone on the surface itself (Sarkar and Singh 2003). Different combinations of inlet velocity and nozzle design will result in comparable Reynold's numbers but might result in non-comparable flow patterns. According to the oven manufacturer, the choice of the design parameters is largely based on long-time experience and gradual improvements of the basic design.

In this work, the air velocity in the free jet zone was measured as a step in validation of the new batch oven compared to a tunnel oven. Due to the turbulence of the air flow through the nozzles, the used anemometer probe was not able to measure the maximum velocity of 12 m/s (this point is further elaborated later). The measured values were

reproducible and are used in the following. For modeling work, a more suitable method should be used, as for example, particle image velocimetry (Senter and Sollic 2007).

The exhaust air can be recirculated or exchanged for fresh air if lower humidity or cooler air is needed. The ability to separate the relative inlet air volume flow into the top and bottom air ducts adds flexibility to the control of the process conditions.

In the present work, a 10-m tunnel oven was used for validation of the new batch oven. The oven has two zones and for the reported experiments, the same conditions were used in the two zones. This oven is placed at Haas-Meincke A/S's production facility in Skovlunde, Denmark. Its main use is as a test facility for costumers testing new products or processes. According to Haas-Meincke A/S, products baked in this oven are considered representative for products baked in larger tunnel ovens with similar settings.

The Batch Oven. The main feature in the new oven is its convective system. The system has the same options for control as the tunnel ovens, such as the air temperature and the top : bottom inlet air distribution. Additionally, the air velocity can be regulated. The convective system is shown schematically in the Fig. 2.

The hot inlet air enters the baking chamber through 13 mm nozzles in the air ducts. The nozzles are positioned in a staggered pattern and the air jets are guided by the rounded rim of the nozzles. The batch oven pattern and dimensions are shown in Fig. 3.

To avoid spot burning and to simulate the movement of the baking band through the tunnel oven, the air ducts (above and below the products) are movable. A movement (left to right) of 0.1 m equals half the distance between two nozzles on the same horizontal line. For the product, this distance of oscillation will correspond to traveling through a tunnel oven giving a uniform exposure to the inlet air.

The differences in the product movement in a tunnel oven and the batch oven were considered early in the design process. In the batch oven, the movement will be slowly oscillating, while the movement in the tunnel oven will be continuous in one direction. In other studies, such as Baik and Marcotte 2003, the air velocity around the product has been expressed as the "relative air velocity." In tunnel ovens, the movement of the baking band has been showed to influence the air flow pattern around the products, when the total air flow is low. Low air flow is normally seen with natural convection, e.g., caused by direct or radiation heating. In the present study, forced convection was applied. With the stated average linear inlet air velocity of 12 m/s, or the measured velocities of 7–8 m/s, and a band velocity of 0.02 m/s (= the velocity for a baking time of 8 min in the

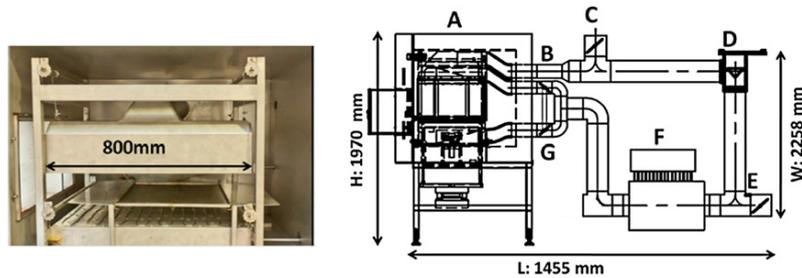

FIG. 2. LEFT: A PICTURE OF THE BAKING AREA IN THE OVEN CHAMBER. RIGHT: A SCHEMATIC ILLUSTRATION OF THE BATCH OVEN. The left part (A) is seen from the side, while the rest of the illustration (B–G) is seen from above. H is the height of the oven chamber, L the length of oven chamber and air system, W the width of the oven chamber and air systems. A, oven chamber; B, humidity sensor; C, fresh air inlet; D, ventilator; E, air exhaust; F, heating unit; G, ducts adjusting top and bottom inlet air.

10 m oven), the inlet air velocity is around 600 (or 350) times that of the product. Therefore, the effects of side-to-side movement versus the one-directional movement do not significantly influence the air flow pattern compared to a stationary or a steadily moving band (Senter and Sollicc 2007).

An additional feature of the air ducts is an option to adjust the distance from the inlet nozzles to the baking tray. The adjustable distances are 0–0.27 m above and 0.03–0.15 m below the product.

Measuring and Control Equipment. In the batch oven, the product weight is measured continuously during baking. The baking tray is placed on a scaffold with four legs passing through holes in the bottom of the oven chamber and resting on a scale, Signum Suprime level 1, Sartorius (Goettingen, Germany). It has a maximum load capacity of 35 kg with an accuracy of 0.1 g. The high capacity of the scale is chosen to allow for experiments with different tray thicknesses and materials. Air humidity is

measured with a Yokogawa High Temperature Humidity Analyzers type ZR22G-040 (Tokyo, Japan) in the outlet air. Steam can be injected directly into the oven chamber, controlled by a feedback control system from the humidity sensor. The air temperature is measured by two stationary temperature sensors. The sensors are placed in the air stream between the heating element and the baking chamber and in the baking chamber above the baking tray, respectively. The oven is designed so that installation of additional sensors is possible if needed at a later time. A window is placed in the side of the baking chamber enabling visual and possible photographic observations of the products during baking.

The Test Product. In the validation experiments, the test product was a butter cookie. The recipe, shown in Table 1, was provided by Haas-Meincke A/S as an example of a typical cookie product baked in convection tunnel ovens. After rolling the dough to a height of 6 mm (± 0.5 mm), the cookies were cut with a circular cutter with a diameter

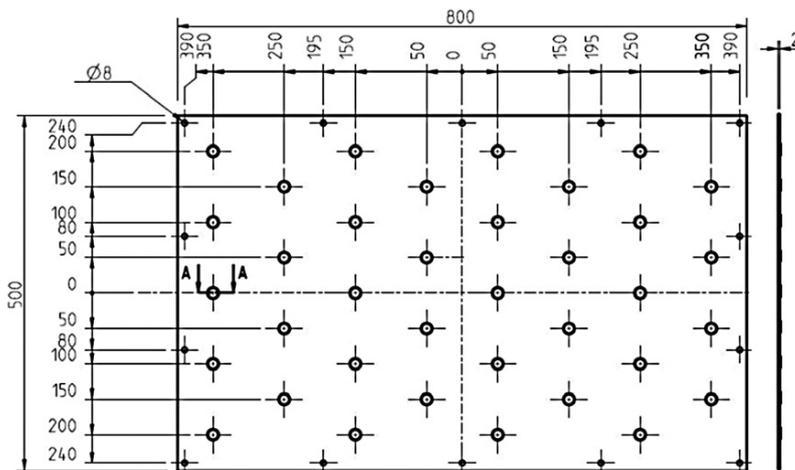

FIG. 3. DIMENSIONS OF THE INLET PART OF THE AIR DUCTS, DISTANCES GIVEN IN MM. The upper air duct has outlet suction along the two 800 mm sides.

TABLE 1. COMPOSITION AND MIXING PROCEDURE FOR 1.7 KG COOKIE DOUGH

Ingredients	Mass (g)
Icing sugar	333
Margarine	500
Vanilla extract	3.3
Mix until even texture	
Whole egg	33.3
Skimmed milk powder	12.5
Salt	3.3
Sodium bicarbonate	0.4
Water	8.3
Mix until even texture	
Corn starch	167
Wheat cake flour	667
Mix until an even textured dough is obtained	
Finish by gathering the dough by hand	
Total weight	1,728

of 45 mm. The same cutter was used for all cookies. Between shaping and baking, the cookies were stored cold (5°C), covered by plastic film to avoid dehydration of the surface. The ingredients were mixed using a Varimixer Bear Teddy (5 L) mixer (Varimixer, Charlotte, NC) and rolled using a Rollmatic manual sheeter (Rollmatic, Schio, Italy).

Validation of the Batch Oven

A two-step validation process was carried out. The first step was focused only on the batch oven itself. The second step on reproducing tunnel oven products. The product quality parameters in the comparison tests are the product color and the weight loss during baking.

These two quality parameters were chosen as they represent both the heat and the mass transfer processes taking place during baking. The weight loss is the total loss for baking and cooling measured with 0.1 g accuracy.

The color of the cookies was evaluated by visual comparison and by objective measurements of the surface. The visual evaluation was based on comparison with pictures of cookies representing a six-step scale (1–6), in increasing degree of browning (Fig. 4). If a cookie was assessed to be between two categories, it was systematically assigned the lowest value. Cookies ranked below 1 are not completely

**FIG. 4.** STANDARD GRADING OF COOKIES, ACCORDING TO THE DEGREE OF BROWNING

Cookies baked less than group 1 are not considered baked through and cookies darker than group 6 are considered burned.

baked. Cookies in categories 1 through 5 are increasingly browned, but still acceptable, and cookies in category 6 are starting to scorch at the sides.

While the subjective categorization of the products is a fast and global method of evaluation, taking the whole surface into account, a more objective way of evaluation was also investigated. For this, the L^* value in the CIE $L^*a^*b^*$ system was used. Using the L^* value as a measure for the degree of browning is a widely accepted method applied by other researchers such as (Zanoni *et al.* 1995; Broyart *et al.* 1998; Baik 2000a; Ahrne *et al.* 2007; Purlis and Salvadori 2009). After baking and cooling, photographic pictures were taken of the cookies together with a reference color matrix. Using Adobe Photoshop Lightroom 4 (Adobe Systems Incorporated, San Jose, CA) and Picture Windows Pro v. 6.0.9 by Digital Light & Color (Digital Light & Color, Cambridge, MA), corrections were made for the lighting and a blur was laid across the cookie surface. The average L^* value of 9 pixels was measured at four points at a distance of approximately 1/3 of the way from the edge to the center, and at the center. The average of these five points gives a measure for the surface lightness and the standard deviation a measure for the variation across the surface for each cookie. Determination of the L^* value: an area with standard gray value was used for exposure compensation of the singular exposures ($R = 90\%$; $G = 90\%$ and $B = 90\%$). Then, the relevant RGB values were read at the cursor position at specified points on the surface of the samples. The recorded values were transformed to XYZ values and further to CIE $L^*a^*b^*$ – values with standard illuminant D_{65} . The calculations were performed using an online calculator (<http://www.easyrgb.com>).

Uniform Heating and Baking

The oven's ability to heat and bake evenly was investigated in two steps:

- (1) Measurements of the local heat transfer coefficients across the baking tray.
- (2) Browning of cookies across the baking tray.

Measurements of the local heat transfer coefficients were used to examine whether the air flow and baking conditions are uniform across the baking plate. The heat transfer coefficient from air to a solid body is a function of the air velocity around the body, the thermophysical properties of the air, and the geometry of the body (including surface roughness). This is conventionally expressed as different relations between the dimensionless Nusselt's number (Nu), the Reynold's number (Re) and the Prandtl's number (Pr) The Nusselt's number given in Eq. (1) is a function of the heat transfer coefficient, h [$W/(m^2K)$], the characteristic length of the investigated body, D_h (m) and the thermal conductivity of the fluid, k_f ($W/[m\cdot K]$):

$$Nu = \frac{h \cdot D_h}{k_f} \quad (1)$$

Equations for the Reynold's and Prandtl's numbers are given in Eqs (2a) and (2b).

$$Re = v \cdot D_h \cdot \rho / \mu \quad (2a)$$

$$Pr = C_p \cdot \mu / k_f \quad (2b)$$

v is the air velocity (m/s), ρ , μ and C_p are respectively the density (kg/m³), viscosity (Pa s) and heat capacity of the air (J/[kg K]).

As appears, Nu and hence h is independent of the thermal properties of the solid body heated or cooled by convective heat transfer (Achenbach 1977).

For a flat plane geometry, the Nusselt relation is given in Eq. (3) (Carson *et al.* 2006).

$$Nu = 0.665 Re^{\frac{1}{2}} Pr^{\frac{1}{3}} \quad (3)$$

Experimentally, it is very difficult to estimate the local air velocity by the product accurately as it is disturbed by local turbulence (Carson *et al.* 2006). Therefore, the experimentally based lumped capacitance model is usually applied instead. This method is described in the following.

The governing hypothesis in the lumped capacitance model is that a body with a Biot number ($h \cdot D_h / k_p$) below 0.1 (preferably <0.01), is subject to a uniform temperature distribution, where k_p is the thermal capacity of the product. When this is the case, Eq. (4) can be used to calculate the heat transfer coefficient (Mills 1995; Nitin and Karwe 2001; Carson *et al.* 2006; Sakin *et al.* 2009):

$$h = -\ln \left(\frac{T_s - T}{T_s - T_0} \right) \frac{m c_p}{A t} \quad (4)$$

where T_s is the temperature of the surroundings (K), T is the product temperature (K), T_0 is the initial temperature (K), m is the mass of the disk (kg), c_p is the specific heat capacity of the disk material (J/[kg K]), A is the surface area (m²), and t is the heating time (s).

With the characteristic length of the cookies being half the height and a thermal conductivity at approximately 0.2 W/(m·K) (based on dough composition and Choi and Okos 1986) the Biot number will exceed 0.1 at $h > 6.7$ W/(m²K). This value is estimated to be below the investigated range. Therefore, the cookies must be substituted by a material with a higher thermal conductivity. Following the work of (Nitin and Karwe 2001) and (Sakin *et al.* 2009), aluminum is used for the temperature measurements. Cylinders (height 6 cm, diameter 4 cm) were used and the local heat transfer coefficients were measured at 24 different positions across the baking tray.

Using $k = 170$ W/(m·K) for aluminum, it can be calculated that the Biot number is below 0.01 as long as the heat transfer coefficient does not exceed 230 W/(m²K) (which would be an extremely high value for convection heating by air), thus the conditions for using Eq. (4) are fulfilled. To keep the conditions as similar as possible to the actual baking process, the standard baking tray was used without insulation or other modifications. The baking tray was cooled before the measurements to minimize excess heat transfer from a preheated baking tray.

Cookies were baked in different position across the baking tray and evaluated for even browning. The cookies were prepared following the recipe in Table 1. The cookie positions were the same as those used in the heat transfer measurements.

The oven settings for both experiments were equal top : bottom inlet air distribution, with dampers opened to 50%, air temperature of 170C and a baking time of 8 min. After baking, the browning was evaluated based on the seven-step scale only. The distance from the inlet nozzles to the product was 15.4 cm.

Comparison to Tunnel Oven Products

When similar settings are used in the batch and tunnel oven, comparable product qualities must be obtained. The described butter cookies were used for comparison tests. The oven parameters used as set points were the temperature by the band or baking tray, the inlet air velocity, the distribution between top : bottom inlet air, the air duct to band distances and the baking time. Browning and the total weight loss were used as product quality parameters and measured as described.

The robustness of the reproducibility was tested by changing one of the initial processing parameters, the air temperature. All the tested temperatures were 160C, 170C, 190C and 200C.

A 10-m indirectly fired convection tunnel oven was used as reference oven. The two zones of the oven were set to the same temperature and inlet air distribution in all the reported baking experiments. It was possible to measure the temperature just above the baking band during processing. This was done through a hatch halfway down the length of the oven. Measuring the air velocity was more complicated. It was not possible to reach a sufficient number of inlet nozzles through the hatch; therefore, two maintenance panels needed to be removed to gain sufficient access and the measurements were carried out at room temperature. The change in temperature will only affects the flow pattern slightly (Marcroft and Karwe 1999). Accordingly, the velocity adjustments in the batch oven were done at room temperature.

	← Left		→ Right		
Window	57	61	59	57	Back
	65	63	59	59	
	63	68	61	65	
	68	68	67	59	
	68	65	61	57	
	61	61	67	59	
	Oven door				

FIG. 5. THE MEASURED HEAT TRANSFER COEFFICIENTS ($W/(M^2K)$)
The orientation in the oven is given as "front/back," "left/right" and the positions of the window and the door are indicated.

When the air enters the baking chamber through the inlet nozzles, the air flow pattern becomes diffused and is far from a fully developed flow as discussed previously in *The Batch Oven*. Two types of anemometer sensors were tested in the pre-experimental work, a rotating vane and a pitot tube connected to a Testo 400 logging unit, Testo AG, (Lenzkirch, Germany). To focus the inlet air stream, a plastic tube was used to frame the inlet hole during measurements. While the distance between the band and the inlet nozzles did not allow for the flow to be fully developed, it increased the accuracy of the velocity measurements.

While good reproducibility was seen between the different nozzles and repetitions at the same nozzle, there was a difference between the two sensors. The measurements with the vane probe only showed an average inlet velocity around 2 m/s while the pitot tube showed an average inlet velocity of approximately 7.5 m/s. The oven manufacturer reports the mean linear velocity to be 12 m/s; therefore, the pitot tube with the plastic tube was chosen as the velocity measurement system. The measurements were used solely to adjust the batch oven and not for further calculations. The average inlet velocities were measured once in 16 nozzles in the batch oven and twice in the tunnel oven. Each of these measurements is an average value obtained over 10 s with a sample rate of 1/s.

RESULTS AND DISCUSSION

Even Heating and Baking in the Batch Oven

The average heat transfer coefficient measured with the lumped capacity method from the 24 measuring points across the baking tray was $62 W/(m^2K)$ with a relative standard deviation of 4.5%. The total range covering 57 to $68 W/(m^2K)$. An overview is shown in Fig. 5. The variation is small

and indicates uniform heating across the baking tray; no systematic variations were seen over the measured area.

Following the observation that no significant differences were seen for the heat transfer coefficients across the baking tray, it was investigated if the browning of cookies was likewise uniform across the baking tray. Cookies were baked in the same positions and under the same conditions as used for the heat transfer measurements. A picture of a batch of cookies can be seen in Fig. 6. All cookies were ranked in category 2. The results indicate that with the measured variation in heat transfer coefficients, the browning, when evaluated as in this work, does also not vary significantly.

As discussed previously, the measured heat transfer coefficients are not directly applicable to the cookies because of differences in geometry and surface roughness between aluminum cylinders and cookies. However, for cookies of similar size and surface roughness, the ratio between the Nusselt's number of the aluminum cylinders and the Nusselt's number of the cookies must be a constant. Thus, uniform values of the measured heat transfer coefficients imply that the heat transfer coefficients of the cookies are also uniform across the baking tray. This is in accordance with the observation that the browning of the cookies is uniform.

Comparison of Baking in the Batch and a Tunnel Oven

Air Velocities. The air velocities measured in the tunnel oven are shown in Table 2 along with the best match

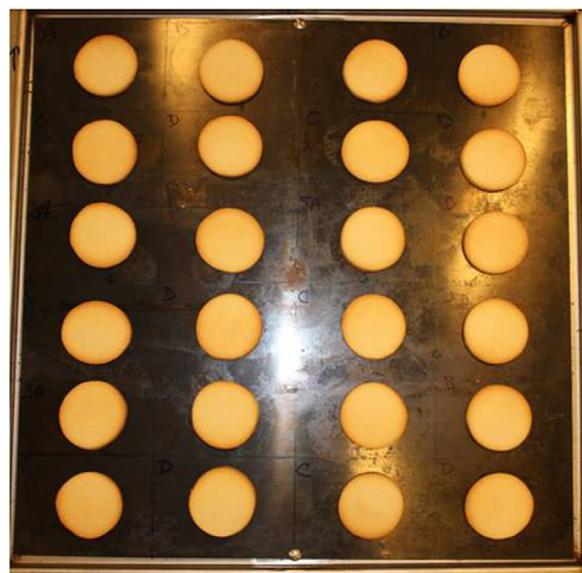

FIG. 6. COOKIES BAKED IN THE BATCH OVEN

TABLE 2. THE AIR VELOCITIES (M/S) WITH OVENS SET TO A 50:50 DISTRIBUTION BETWEEN TOP AND BOTTOM INLET AIR DUCTS, STANDARD DEVIATIONS ARE GIVEN AFTER THE AVERAGE VALUES

Inlet area	Tunnel oven (m/s)	Batch oven (m/s)
	Average	Average
Top	7.1 (0.7)	6.8 (0.2)
Bottom	7.8 (0.5)	8.0 (0.2)

Number of measurements: $n = 32$ in the batch oven and $n = 16$ in the batch oven.

obtained in the batch oven. A two-side Student's t -test showed no significant difference between the mean values for either top or bottom air ducts ($P = 0.12$).

Results of Comparisons. Based on the used quality parameters, good reproducibility was seen (Tables 3 and 4, rows for $T = 170\text{C}$). Even with the evident differences between a batch and a tunnel oven, the baking process appears to be reproducible in the new oven.

The average measured L^* values were for cookies from the tunnel oven 65 and 69 for cookies baked in the batch oven, with standard deviations of 3.2 and 2.8, respectively. Having only 5 or 6 cookies from each oven further statistical analysis is not performed. When comparing to the six categories, the cookies were all in category 2.

The average water loss was found as the total mass loss per cookies due to slight variations in the cookie height (± 0.5 mm). Five cookies were measured for the tunnel oven, six for the batch oven (Tables 3 and 4); the average

values were found to be 1.2 g/cookie in the tunnel oven and 1.3 g/cookie in the batch oven.

Varying the Oven Settings

Using the air speed, inlet air distribution and baking time of 8 min from the previous experiments, the effects of changing the temperature on the product quality was tested both in the batch and tunnel ovens. The additional tested temperatures were 160C, 190C and 200C. The product and quality parameters were the same as in the previous experiments. The color ranking and the L^* values are shown in Table 3, and the weight loss data in Table 4, both including the results from the initial comparison experiments.

Considering the L^* values, the cookies baked in the batch oven appear slightly lighter than those from the tunnel oven. The ranking indicates that the overall impression of the cookies was the opposite. This small contradiction might be a result of the L^* value measuring points, not including the outer rims of the cookies, which will brown first. The weight loss data (Table 4) show little differences between the treatments. For both ovens, a clear trend of increasing weight loss with increasing temperatures is observed.

The quality changes when varying the air temperature were overall seen to be similar in the two ovens. However, the quality parameters further indicate that work is needed to enhance the uniformity of baking across the baking tray in the batch oven at higher temperatures. The small contradictions between L^* values and browning categories call for a better evaluation method of the global browning

Temperature (C)	Color evaluation (categories)		Lightness (average L^* values)	
	Tunnel	Batch	Tunnel	Batch
160	1, 1, 1, 1, 1	2, 1, 2, 1, 1, 1	65 (5.2)	72 (1.5)
170*	2, 2, 2, 2, 2	2, 2, 2, 2, 2, 2	65 (3.2)	69 (2.8)
190	4, 4, 4, 4, 4	4, 4, 4, 4, 3, 4	54 (4.2)	53 (5.7)†
200	5, 5, 5, 5, 5	5, 5, 5, 5, 6, 5	41 (5.7)	45 (4.6)

The color categories are shown for all cookies. $n = 5$ cookies for the tunnel oven or and $n = 6$ cookies for the batch oven.

* Results from the initial comparison experiments.

† Only 5 of the 6 cookies were available for this measurement.

TABLE 3. DATA FOR VALIDATION EXPERIMENT, COMPARING THE BATCH OVEN WITH THE TUNNEL OVEN, STANDARD DEVIATIONS ARE SHOWN AFTER AVERAGE VALUES

Temperature (C)	Weight loss (g/cookie)	
	Tunnel	Batch
160	1.2, 1.2, 1.2, 1.1, 1.1 (1.2)	1.2, 1.2, 1.2, 1.2, 1.2, 1.2 (1.2)
170*	1.2, 1.2, 1.2, 1.3, 1.2 (1.2)	1.3, 1.3, 1.3, 1.2, 1.2, 1.3 (1.3)
190	1.4, 1.4, 1.4, 1.4, 1.3 (1.4)	1.3, 1.5, 1.5, 1.4, 1.3, 1.4 (1.4)
200	1.5, 1.5, 1.5, 1.5, 1.5 (1.5)	1.3, 1.5, 1.2, 1.6, 1.5, 1.5 (1.4)

* Results from the initial comparison experiments.

TABLE 4. THE WEIGHT LOSS FOR EACH COOKIE (G/COOKIE) ARE SHOWN FOLLOWED BY THE AVERAGE VALUE

impression of cookies, possibly an integration of L^* values at the upper surface could be used.

Besides a more thorough investigation and possibly revalidation of the uniformity of heating in the batch oven, future work should include a flow measuring system. This will enable a more controlled air flow and help in future work with modeling of the heat and mass transfer in bakery products. A relative wide-ranging browning category scale with all acceptable degrees of browning was applied. If only a small range of browning was to be evaluated in future work, two of the categories could be selected and further divided into smaller intervals for a more precise estimate of the degree of browning.

In the future, the oven will be used to characterize the effect of varying process parameters on the product quality. Especially, process parameters, which are not easily changed in a full-scale tunnel oven, can be investigated. An example might be the effect of changing the inlet air velocity, and thus, the heat transfer coefficient, on the product quality.

CONCLUSION

A new experimental batch oven has been designed and constructed to simulate baking in continuous tunnel ovens. Especially, the convective inlet air system has been constructed as close to the investigated tunnel oven as possible, with the addition of adjustable air velocity. It has been showed that heating and baking are uniform across the baking surface in the new oven. Furthermore, it is possible to reproduce baking processes as seen in continuous convective tunnel ovens. Butter cookies were used as a model product to investigate the reproducibility.

ACKNOWLEDGMENTS

The authors would like to thank the Danish Ministry of Food, Agriculture and Fisheries for grants supporting this research (J.no. 3414-08-02280). We would also like to thank the staff at Haas-Meincke for assistance and good collaboration throughout this project.

REFERENCES

- ACHENBACH, E. 1977. The effect of surface roughness on the heat transfer from a circular cylinder to the cross flow of air. *Int. J. Heat Mass Transf.* 20, 359–369.
- AHRNE, L., ANDERSSON, C., FLOBERG, P., ROSEN, J. and LINGNERT, H. 2007. Effect of crust temperature and water content on acrylamide formation during baking of white bread: Steam and falling temperature baking. *LWT-Food Sci. Technol.* 40(10), 1708–1715.
- BAIK, O. 2000a. Cake baking in tunnel type multi-zone industrial ovens Part I. Characterization of baking conditions. *Food Res. Int.* 33(7), 587–598.
- BAIK, O. 2000b. Cake baking in tunnel type multi-zone industrial ovens Part II. Evaluation of quality parameters. *Food Res. Int.* 33(7), 599–607.
- BAIK, O. and MARCOTTE, M. 2003. Modeling the moisture diffusivity in a baking cake. *J. Food Eng.* 56(1), 27–36.
- BROYART, B., TRYSTRAM, G. and DUQUENOY, A. 1998. Predicting colour kinetics during cracker baking. *J. Food Eng.* 35, 351–368.
- CARSON, J.K., WILLIX, J. and NORTH, M.F. 2006. Measurements of heat transfer coefficients within convection ovens. *J. Food Eng.* 72, 293–301.
- CHOI, Y. and OKOS, M.R. 1986. Effects of temperature and composition on the thermal properties of foods. In *Food Engineering and Process Applications: Proceedings of the Fourth International Congress on Engineering and Food* (held between 7 and 10 July at Edmonton, Alberta, Canada), pp. 93–101, Elsevier Applied Science Publishers.
- FROST, D.J., ADHIKARI, K. and LEWIS, D.S. 2011. Effect of barley flour on the physical and sensory characteristics of chocolate chip cookies. *J. Food Sci. Technol.* 48(5), 569–576.
- MANLEY, D. 2000. *Technology of Biscuits, Crackers and Cookies*, 3rd Ed., p. 51, Woodhead Publishing Limited, Cambridge, UK.
- MARCROFT, H.E. and KARWE, M.V. 1999. Flow field in a hot air jet impingement oven – part I: A single impinging jet. *J. Food Process. Preserv.* 23, 217–233.
- MILLS, A.F. 1995. *Heat and Mass Transfer*, pp. 29–33, Richard D. Irwin, Inc, Homewood, IL.
- MIN, B., BAE, I.Y., LEE, H.G., YOO, S. and LEE, S. 2010. Utilization of pectin-enriched materials from apple pomace as a fat replacer in a model food system. *Bioresour. Technol.* 101(14), 5414–5418.
- MIRADE, P., DAUDIN, J., DUCEPT, F., TRYSTRAM, G. and CLEMENT, J. 2004. Characterization and CFD modelling of air temperature and velocity profiles in an industrial biscuit baking tunnel oven. *Food Res. Int.* 37(10), 1031–1039.
- NITIN, N. and KARWE, M.V. 2001. Heat transfer coefficient for cookie shaped objects in a hot air jet impingement oven. *J. Food Process Eng.* 24, 51–69.
- PAREYT, B., TALHAOU, F., KERCKHOFS, G., BRIJS, K., GOESAERT, H., WEVERS, M. and DELCOUR, J.A. 2009. The role of sugar and fat in sugar-snap cookies: Structural and textural properties. *J. Food Eng.* 90(3), 400–408.
- PURLIS, E. and SALVADORI, V.O. 2009. Modelling the browning of bread during baking. *Food Res. Int.* 42(7), 865–870.
- SAKIN, M., KAYMAK-ERTEKIN, F. and ILICALI, C. 2009. Convection and radiation combined surface heat transfer coefficient in baking ovens. *J. Food Eng.* 94, 344–349.
- SARKAR, A. and SINGH, R.P. 2003. Spatial variation of convective heat transfer coefficient in air impingement applications. *J. Food Sci.* 68, 910–916.

- SARKAR, A., NITIN, N., KARWE, M.V. and SINGH, R.P. 2004. Fluid flow and heat transfer in air jet impingement in food processing. *J. Food Sci.* 69(4), 113–122.
- SENDER, J. and SOLLIEC, C. 2007. Flow field analysis of a turbulent slot air jet impinging on a moving flat surface. *Int. J. Heat Fluid Flow* 28, 708–719.
- SOMMIER, A., CHIRON, H., COLONNA, P., DELLA VALLE, G. and ROUILLE, J. 2005. An instrumented pilot scale oven for the study of French bread baking. *J. Food Eng.* 69(1), 97–106.
- ZANONI, B., PERI, C. and BRUNO, D. 1995. Modelling of browning kinetics of bread crust during baking. *Lebensm. Wiss. Technol.* 28(6), 604–609.
- ZAREIFARD, M.R., MARCOTTE, M. and DOSTIE, M. 2006. A method for balancing heat fluxes validated for a newly designed pilot plant oven. *J. Food Eng.* 76(3), 303–312.
- ZAREIFARD, M.R., BOISSONNEAULT, V. and MARCOTTE, M. 2009. Bakery product characteristics as influenced by convection heat flux. *Food Res. Int.* 42(7), 856–864.

Appendix E

Abstract: Investigating the influence of air velocity on the quality of butter cookies

This appendix contains the abstract “*Investigating the influence of air velocity on the quality of butter cookies*”, the results were presented as an oral presentation at the Conference of Food Engineering, Leesburg, VA, USA, April 2012.

Investigating the influence of air velocity on the quality of butter cookies

Mette Stenby and Jens Adler-Nissen

Technical University of Denmark, National Food Institute, Kgs. Lyngby, Denmark.

In the baking industry the operators' knowledge of the products and the processing equipment is important for the daily operations. This is, however, not the ideal basis for a rational optimization of processes and equipment. Together with a manufacturer of industrial tunnel ovens the authors are engaged in a joint research project which aims at increasing the quantitative knowledge of baking processes. The overall scope of the project is to develop robust product-process models for baking in convective tunnel ovens. These models should be able to predict changes in the product quality based on changes in the process conditions. The present work is concerned with both the relation between the heat transfer coefficient and the mass loss, and the influence of the air velocity in the oven on these factors.

The test product in this work is a simple butter cookie. The quality parameters used to estimate the effects of changing the air velocity are the average lightness (L^*) on the surface of the cookie (correlated to browning), and the overall product mass loss during baking. The surface browning is mainly a result of Maillard reactions. These reactions do not occur until the surface is sufficiently dry and have a sufficiently high temperature. Both quality parameters are functions of the heat and mass transfer at the surface, and are therefore considered to be good indicators for the effects of changing the air velocity.

The experimental work was done in a specially designed pilot plant batch oven, where the air system has been designed to mimic the air flow in industrial convection tunnel ovens. The air temperature, the air velocity, and the distance from air ducts to product are adjustable along with the type of the baking tray, as different designs and materials are used for baking bands in the industry. The batch oven is equipped with temperature sensors, a humidity sensor, and the ability to measure the product weight continuously during baking. Especially the product weight was used to characterize the baking process when preparing the butter cookies. From the experimental work it was found that it is possible to estimate the effect on the quality parameters from changes in air velocity. A good correlation was found between the convective heat transfer coefficient and the mass loss. The mathematical model was tested against cookies baked in a tunnel oven, and the quality parameters were well predicted when the heat transfer coefficient was known from separate measurements.

Appendix F

Abstract: Investigation of uneven mass transfer in butter cookies combining experimental work and finite element modeling

This appendix contains the manuscript “*Investigation of uneven mass transfer in butter cookies combining experimental work and finite element modeling*”. The manuscript was submitted to *International Journal of Food Engineering*, June 17, 2013.

Investigation of uneven mass transfer in butter cookies combining experimental work and finite element modeling

Mette Stenby Andresen¹

¹*Division of Industrial Food Research, National Food Institute, Technical University of Denmark (DTU), Søtoftsplads 227, Kongens Lyngby 2800, Denmark.*

Abstract

During baking of cookies, the baking tray is assumed to influence evaporation and thus the product properties. However, the magnitude and importance of this influence is not well understood. The purpose of this work is to improve this understanding through numerical modeling combined with experimental data. The influence of the barrier created by the baking tray on the overall water evaporation and the product temperature is examined. During baking the mass loss and the center temperature are continuously measured for butter cookies. Heat and mass transfer equations are subsequently solved numerically and optimized against the experimental data. Three simulation set-ups are investigated. 1) Symmetrical mass transfer, with equal boundary conditions for all surfaces, 2) an asymmetric set-up with decreased mass transfer from the bottom surface, compared to the top and side surfaces, and 3) an asymmetric set-up with no evaporation from bottom surface, in contact with the baking tray. The experimental work is carried out in a specially designed pilot plant batch oven. The oven is a unique experimental oven constructed to emulate the conditions in an indirectly heat continuous convection tunnel oven. Good agreement is obtained between simulations and measurements for the over-all mass loss the three simulation set-ups. However comparing the simulated and measured development in the center temperature it is found that an assumption of no evaporation from the bottom surface seems unrealistic; thus, evaporation through the bottom surface of the cookie is important for combined heat and mass transfer of cookie products.

Introduction

Work aiming at increasing the knowledge of the relation between baking process conditions and the properties of the bakery products is of high interest and value for both equipment suppliers and the bakery industry. Such work can help optimize the baking process, through improved process planning, oven design, and construction. In the present work new data from a unique pilot scale batch oven is combined with finite element modeling to explore mass transfer during baking of cookies. The oven is constructed to emulate continuous tunnel oven baking and data is continuously recorded during the entire baking process (1). This type of data is scarce and detailed modeling will require even more data in the future.

Mathematical simulations of heat and mass transfer in bakery products during baking are widely used to explain and understand the product and quality changes taking place in the transition from dough to finished product (2-9). The focus of the present study is to incorporate the effect of covered surfaces, such as the bottom surface of a cookie against a baking tray, on the product mass transfer mechanisms during baking.

Different approaches are seen for heat and mass transfer modeling in food products. Bakery products may be simplified so that they are simulated as infinite slabs (10), infinite cylinders (11), or finite cylinders (7,12). The first two have heat and mass transfer in one direction only, while the latter consider transport processes in two dimensions through the product.

In some cases the effect of a mold or baking tray is not included, and the model is set up having equal boundary conditions at all outer surfaces. In this way an equal evaporation is obtained in all directions away from the product center (11,12). In other cases, for example for products such as biscuits, cakes, and pancakes the water removal may be assumed to happen only from the free product surfaces. In this case no evaporation is included from the covered surfaces to the surroundings (2,10,13,14).

A model for the heat and mass transfer in ring cake baking is presented by Sakin-Yilmazer et al. (7). They include the effect of the mold covering the side and bottom surfaces of the product by lowering the mass transfer. In their presented modeling work the ratio between the mass transfer coefficients applied for the side and top surfaces is 0.65, and 0.7 between the bottom and top surfaces (7).



Figure 1. Bottom surface of butter cookie. Bubbles caused by water vapor are seen across the surface.

On the bottom surface of butter cookies, the product used as a model in this work, bubble formation is clearly observed as seen in Figure 1. The most likely mechanism describing these bubbles is that they arise from water evaporating on the bottom surface when leaving the product. The water vapor then moves along the bottom surface, toward the outer edges, and away from the product. It is interesting to investigate how this evaporation at the bottom surface influences the over-all heat and mass transfer in the product. Some bakery products are baked on steel plates while others on perforated plates or steel meshes. This study can help clarify if the choice of tray design influences the heating and drying of the product during baking, assuming the heat transfer is not affected by the thickness or material of the baking tray. Thick baking trays or stone surfaces will influence the heat transfer and are not considered in the present work. The mass flux is examined as the relative evaporation rate between the free and covered surfaces.

In the present work the scope is to develop a robust model, which is sufficiently simple to enable easy modeling, but still complex enough to give a good description of the investigated product parameters. The focus is on heat and mass transfer, and the validation of the model is made by comparison with the measured mass loss and center product temperature during baking. Three set-ups are investigated: a symmetrical case with equal mass transfer boundary conditions, an asymmetrical set-up with no mass transfer from the bottom surface, and an intermediate set-up with a finite mass transfer coefficient at the bottom surface lower than that of the free surfaces.

In the present work physically based mathematical models, with empirically determined or calculated parameters, are solved numerically for heat and mass transfer during baking of butter cookies. The numerical solution method is by use of a finite element method (FEM) with the commercial software COMSOL 4.3. This method has been

successfully applied in other studies solving heat and mass transfer equations for different food products, a few examples are: contact baking (2), bread baking (11,15,16), chicken patties (17), and other bakery products such as biscuits and cakes (3,12).

The purpose of this work is to investigate the influences of the baking tray on the mass flux, through comparison of modeling work and experimental data obtained from a unique batch oven specially designed to emulate continuous tunnel oven baking processes (1). The oven was designed and constructed in collaboration with the company Haas-Meincke A/S¹, manufacturers of equipment for the bakery industry, including continuous tunnel ovens. The control parameters used for comparison are the product center temperature and the overall evaporation of water.

Materials and Methods

Batch oven

The butter cookies were baked in a specially designed batch oven. The interior of the oven chamber and its convective system are shown in Figure 2. In order to avoid spot burning the air ducts, with inlet air holes above and below the baking tray, move from side to side during baking, thus simulating the conditions of a baking band moving relatively to the stationary air ducts in a tunnel oven.

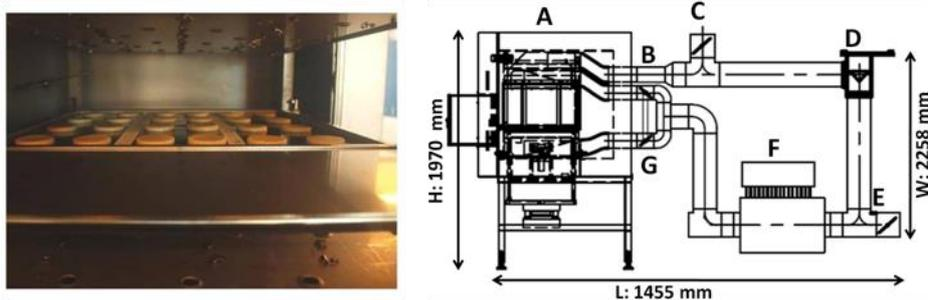

Figure 2 2a: A picture taken through a side window in the oven, showing the inlet air nozzles above and below the baking tray. 2b: A schematic illustration of the oven and the convective system. The left part of the schematic (A) is seen from the side, while the rest of the illustration (B - G) is seen from above. H is the height of the oven chamber, L the length of oven chamber and air system, W the width of the oven chamber and air systems. A - oven chamber, B - humidity sensor, C - fresh air inlet, D - ventilator, E - air exhaust, F - heating unit, G - ducts adjusting top and bottom inlet air.

In the present work the ability of the oven to continuously measure the product weight is of special importance in relation to validation of the mathematical model. The baking tray and its support structure are placed on a scale, Signum Suprime level 1 with a capacity and precision of 35 kg \pm 0.1 g (Germany). Removable sensors may be used to measure the product temperature, as described below.

Measuring the product center temperature

The center temperature of the cookies was measured by placing the thermocouple sensors (Type T) between two round slabs of dough. Each of these having the same diameter (45 mm) and half the thickness of the cookies used for the weight measurement experiments (3 mm), creating a cookie with a total height of 6 mm. The thermocouple sensors were placed

¹ Haas-Meinck A/S, www.haas.com

as close to the center as possible. A total of 14 measurements were obtained from cookies baked at 180°C for 840 s. Due to the possible influence of the thermocouples on the weight and weight measurements, the temperature and product weight were not measured in the same experiments.

Weight loss measurements

Cookies for the weight loss measurements were shaped with a diameter of 45 mm and rolled to a height of 6 mm. The cookies were baked at 180°C for 480 s. During baking the weight of the cookies was measured continuously. The weight loss was measured as the average of 12 cookies with three repetitions. In the following the weight loss is given as a mass fraction (MF), corresponding to the time dependent weight divided by the initial weight of the cookies as shown in Equation (1).

$$MF = \frac{m(t)}{m_{\text{initial}}} \quad (1)$$

Where $m(t)$ is the time dependent weight of the cookies and m_{initial} is the initial weight of the cookies. Periodic disturbances were observed when the air ducts were moving from side to side in the oven. These disturbances resulted in extreme weight measurements. In the present work measurements outside the mass fractional interval [0.860:1.035] are considered outliers and have been removed from the dataset. The limits are determined based on an empirical assessment of the datasets.

Butter cookie recipe

The examined butter cookies were prepared following the recipe in Table 1, provided by Haas-Meincke A/S as an example of a typical industrial cookie product. The ingredients were mixed using a Varimixer Teddy (5L) mixer, and rolled using a Rollmatic manual sheeter. The dough was rolled to a height of either 3 or 6 mm (± 0.5 mm) and cookies were cut with a diameter of 45 mm. The same cutter was used for all cookies. Between shaping and baking the cookies were stored cool (5°C), covered by plastic film to avoid dehydration of the surface. The air temperature was set to 180°C. The investigated baking time was 480 s for studies of the weight loss and 840 s for the center temperature measurements.

Table 1. Recipe for butter cookies.

Ingredients	Mass (g)
Icing sugar	333
Margarine	500
Vanilla extract	3.3
Mix until even texture	
Whole egg	33.3
Skimmed milk powder	12.5
Salt	3.3
Sodium bicarbonate	0.4
Water	8.3
Mix until even texture	
Corn starch	167
Wheat cake flour	667
Mix until an even textured dough is obtained	
Finish by gathering the dough by hand	
Total Weight	1728.1

Mathematical modeling and numerical solution

During baking heat is applied to the product causing physical changes and evaporation of water. Water evaporation begins at the product surfaces when the temperature is sufficiently elevated. Hereafter water is transported towards the surface, both as liquid water by diffusion and gaseous water through pockets and holes in the structure. From the surfaces the water evaporates to the surroundings resulting in drying of the product.

Energy is transferred by radiation from the oven walls, conduction through the baking tray, and convection by the air movement around the product. In the present work a forced convection oven is used for baking. In the modeling work only the convective heat transfer is included. Due to the highly reflective surfaces inside the oven and the light color of the product the contribution from radiation can be neglected. Due to the low thickness (1.3 mm) of the steel baking tray, the transversal conduction is not included in the heat transfer equations. The conduction across the baking tray is sufficiently high to assume equivalent heat transfer as for the free surfaces, corresponding to convective heat transfer. The heat and mass transfer processes are shown schematically in Figure 3. Additional assumptions and simplifications for the modeling work are described in the following.

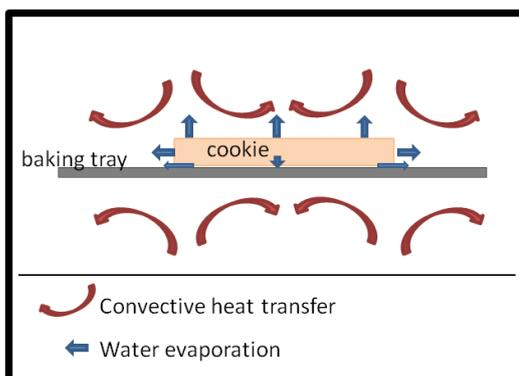

Figure 3. Heat and mass transfer included in the modeling work.

Assumptions and simplifications in the modeling work

The following assumptions and simplifications were applied in the modeling work:

- Heat transfer: An average heat transfer coefficient is used on the entire surface of the product. In the actual baking process the baking tray and local variations in air flow result in varying heat transfer coefficients around the bakery product. These variations are difficult to measure accurately and would furthermore only affect e.g. local water content, while the loss in total water content should be reasonably well characterized by an average heat transfer coefficient.
- Mass transfer: The water transport is modeled as a diffusion process. To simplify the model only average mass transfer parameters are included, combining the transport of liquid water and water vapor. The diffusion coefficient and the mass transfer coefficient should therefore be considered as apparent coefficients.
- Volume and porosity: During baking CO_2 and water vapor will expand the product volume. Additionally water evaporation and solidification of the cookie matrix will change the structure from dense to porous. In the simulations both the volume and the porosity are kept constant. The lumped effect of the changes in volume and porosity is indirectly included in the solutions since the diffusion and mass transfer coefficients are optimized using experimental data.

- Physical properties: The physical properties are calculated throughout the simulations as functions of the water content; all other ingredient properties and relative contents are kept constant.

Governing equations

The heat and mass transfer inside the butter cookie and between the product and the baking chamber were calculated from the following equations and their boundary conditions. Similar to general modeling of heat transfer, the heating of the product is described by conduction following Fourier's law, considering temperature differences in the product as the driving force for energy transport (2,6,7,9,13,17-20).

The cookies are considered as flat finite cylinders and the equations are given in spherical coordinates. The heat transfer equation is shown in Equation (2), with the initial conditions (I.C.) specified in Equation (3) and boundary conditions (B.C.) shown in Equations (4a-c). Due to axial symmetry the heat and mass transport in the angular direction is negligible compared to the transfer in the radial and axial directions.

$$\rho c_p \frac{dT}{dt} = k_T \left(\frac{1}{r} \frac{d}{dr} \left(r \frac{dT}{dr} \right) + \frac{d^2 T}{dz^2} \right) \quad (2)$$

I.C.

$$T(r, z)|_{t=0} = T_0 \quad (3)$$

B.C.

$$k_T \frac{dT}{dr} \Big|_{r=R} = h_T (T_a - T) + \Delta H_{vap} \rho D \frac{dx_w}{dr} \Big|_{r=R} \quad (4a)$$

$$k_T \frac{dT}{dz} \Big|_{z=Z} = h_T (T_a - T) + \Delta H_{vap} \rho D \frac{dx_w}{dz} \Big|_{z=Z} \quad (4b)$$

$$-k_T \frac{dT}{dz} \Big|_{z=0} = h_T (T_a - T) + \Delta H_{vap} \rho D \frac{dx_w}{dz} \Big|_{z=0} \quad (4c)$$

where ρ is the density of the product [kg/m³], c_p the specific heat [J/(kgK)], T the temperature [K], T_0 the initial temperature [K], T_a the temperature of the air [K], t the time [s], k_T the thermal conductivity [W/(mK)], h_T the thermal conductivity [W/(m²K)], ΔH_{vap} the enthalpy of evaporation for water [J/kg], D the diffusion coefficient [m²/s], x_w the water content [kg_{water} / kg_{product}], r the radial direction [m], R the radius of the product [m], z the axial direction [m], Z the height of the product [m].

The water transport is modeled as a diffusion process following Fick's second law with the concentration gradient in the product considered as the driving force for water transfer (20,21). Mass transfer in the axial and radial directions the equation for diffusion is given in Equation (5). The initial conditions are given in Equation (6) and the boundary conditions in Equations (7a-c).

$$\frac{dx_w}{dt} = D \left(\frac{1}{r} \frac{d}{dr} \left(r \frac{dx_w}{dr} \right) + \frac{d^2 x_w}{dz^2} \right) \quad (5)$$

I.C.

$$x_w(r, z)|_{t=0} = x_{w0} \quad (6)$$

B.C.

$$D \frac{dx_w}{dr} \Big|_{r=R} = \begin{cases} 0, & T < T_{vap,w} \\ k_c (x_{w,a} - x_w), & T \geq T_{vap,w} \end{cases} \quad (7a)$$

$$D \frac{dx_w}{dz} \Big|_{z=Z} = \begin{cases} 0, & T < T_{vap,w} \\ k_c (x_{w,a} - x_w), & T \geq T_{vap,w} \end{cases} \quad (7b)$$

$$-D \frac{dx_w}{dz} \Big|_{z=0} = \begin{cases} 0, & T < T_{vap,w} \\ C \cdot k_c (x_{w,a} - x_w), & T \geq T_{vap,w} \end{cases} \quad (7c)$$

where k_c is the average mass transfer coefficient [m/s], $x_{w,a}$ is the water fraction in the air [kg_{water}/kg_{air}], C , a constant between 0 and 1, describing the effect of the baking tray on the evaporation rate, and $T_{vap,w}$ the initiation temperature for water evaporation [K].

In this work three values of C are investigated in the simulation work and compared to the experimental data: A symmetrical set-up in which $C = 1.0$, meaning that the mass flux is equal through all outer boundaries, and two asymmetric set-ups with $C = 0.6$ and 0 , respectively.

When $C = 0.0$ a set-up is obtained where the solid baking tray inhibits all evaporation from the bottom surface. With $C = 0.6$ the mass flux through, and away from, the bottom surface is 60% of the mass flux through the side and top boundaries. The intermediate set-up with $C = 0.6$ is chosen to obtain a situation with some, but not full, evaporation from the bottom surface, as inspired by the work of Sakin-Yilmazer et al. (7). This value is considered as a working estimate to include an intermediate set-up between full symmetrical evaporation and no evaporation from the bottom surface in the present work.

Parameters for the simulations

Properties for the dough, the heat transfer coefficient and the mass transfer properties were determined from standard empirical equations and measurements. The methods are described in this section.

Product properties

The physical properties of product needed for the calculations are: density, specific heat capacity, thermal conductivity, and the diffusion coefficient. All properties were calculated through the simulation based on the changing water content; the properties and content of other constituents (protein, carbohydrates, fat etc.) were kept constant throughout the baking process.

The density was calculated based on the product weight and the assumed constant volume. The average initial weight of 90 un-baked cookies was used as the initial product weight. The density representation in the simulations was as given in Equations (7a-c).

$$\rho = \frac{m_{\text{initial}} - m_{w,\text{evp}}}{V} \quad (8)$$

where m_{initial} is the initial product weight [kg], $m_{w,\text{evp}}$ is the mass of evaporated water [kg], and V the cookie volume [m³]. The specific heat capacity was calculated based on the cookie dough composition and equations presented in (22), shown in Equation (9).

$$c_p = \sum x_i^w c_{p,i} \quad (9)$$

where the x_i^w is the mass fraction of the i^{th} component and $c_{p,i}$ is the specific heat capacity of the i^{th} component. The thermal conductivity is calculated from a parallel model Equation (10), based on the cookie dough components and their volume fractions (22,23).

$$k_T = \sum x_i^V k_i \quad (10)$$

where the x_i^V is the volume fraction of the i^{th} component and k_i is the thermal conductivity of the i^{th} component. The three initial values for the physical properties are shown in Table 2.

Table 2. Initial physical properties for the baking process. Subscript 0 indicates the initial value.

Property [unit]	Value
ρ_0 [kg/m ³]	1300
$c_{p,0}$ [J/(kgK)]	2100
$k_{T,0}$ [W/(mK)]	0.32

Mass transfer properties

For the diffusion coefficient a starting value for the modeling was the experimentally found diffusion coefficient presented by Demirkol et al. (13) for biscuits baked at 190°C with forced convection heating, $D = 3.6 \cdot 10^{-8}$ m²/s. The initial value was subsequently optimized against the experimental data.

Water evaporation is dependent on the surface temperature, the relative air humidity, the air velocity by the product, the diffusion of water inside the product towards the surface, and the surface humidity. In Equation (5) these properties are grouped into a mass transfer coefficient representing these aspects in the model. In the present work the mass transfer coefficient is optimized similarly to the diffusion coefficient. An initial value is estimated and subsequently optimized against the experimental data.

Based on the work presented by Demirkol et al. (13) an initial k_c value was found, from the equation given in Equation (11).

$$k_{c,av} = \frac{\int_0^t \frac{V dY(t)}{A dt Y_0} dt}{t} \quad (11)$$

where $k_{c,av}$ is the average mass transfer coefficient over the investigated process [m/s], V is the product volume [m³], A the total surface area [m²], Y_0 and $Y(t)$ are the initial and time dependent water concentrations (on dry matter basis).

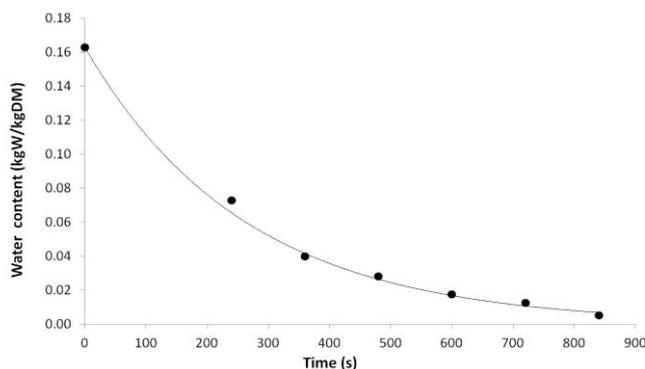

Figure 4. • Experimental measuring points. – Regression line for an exponential approximation to the evaporations. Measurements of the water content on dry matter basis to determine the evaporation rate for calculation of k_c .

$Y(t)$ was empirically estimated as a function of time from initial experimental work measuring the mass loss after different baking times (see Figure 4). The equation is given in Equation (12) on dry matter basis, with the value of Y_0 found to be 0.1628 kg_{water}/kg_{drymatter} from measurements on the unbaked cookie dough.

$$Y(t)_{\text{experimental}} = 0.1628e^{(-3.8 \cdot 10^{-3} \cdot t)} \quad (12)$$

From Equations (11) and (12) the initial value was found to be $k_c = 2.7 \cdot 10^{-6}$ m/s for a 14 min baking process, with the total surface area being $8.48 \cdot 10^{-4}$ m² and the cookie volume $9.54 \cdot 10^{-6}$ m³.

Heat transfer coefficient

The heat transfer coefficient was estimated experimentally by the use of the lumped capacitance model (24). When the physico-chemical properties, the air temperature, and the product temperature are known the heat transfer coefficient of an object with a very low Biot number ($Bi_{\text{cylinder}} = \frac{hTR}{kT} < 0.1$ and preferably < 0.01) can be calculated from Equation (13), see (24-26).

$$\ln \frac{T_a - T}{T_a - T_0} = - \frac{hTA}{mc_p} t \quad (13)$$

The thermal properties of an object do not influence the average heat transfer coefficient. Therefore a different material with no evaporation and a high thermal conductivity can be used to calculate the average heat transfer coefficient. The substitute material in this work was aluminum which has proven a good material for heat transfer studies (26). Still for convective heating the heat transfer coefficient is affected by the flow pattern, influenced by factors such as the geometry and surface roughness (27).

Cylinders in the exact shape of the cookies were found to heat too quickly for the oven to reach a steady state temperature and thus for the model to be valid. Therefore aluminum cylinders with a diameter of 40 mm and a height of 60 mm were used instead. The characteristic length of the two geometries is the diameter, since the air flow close to the cookies is mainly parallel to the baking tray and thus transverse across the cylinders. The values of the diameters are close to each other, but the larger height of the aluminum cylinders may increase the average heat transfer coefficient compared to the actual heat transfer experienced by the cookies. On the other hand the uneven surface of the cookies will result in increased local turbulence, and hence higher heat transfer compared to the smooth aluminum surface. The substitution of the cookie geometry with the aluminum cylinders is therefore considered an acceptable approximation for obtaining heat transfer coefficients.

The same oven settings were applied when measuring the overall average heat transfer coefficient as in the baking experiments. From a triplicate of measurements an average heat transfer coefficient of 63 W/(m²K), with a standard variation of 1 W/(m²K), is found.

Solving the heat and mass transfer equations

The heat and mass transfer equations were solved by the use of numerical finite element method (FEM). The mass transfer and diffusion coefficients were optimized through comparisons between the simulation results and the experimental data. The procedures are described below.

Finite element modeling

When applying FEM the investigated geometry is divided into a finite number of small elements. These elements are connected by node points. In each element the governing equation is approximated by a low order polynomial. The overall solution is thus found by combining all the unique solutions at the node points (28).

In the present work the commercially available FEM solving program COMSOL Multiphysics 4.3 (COMSOL, Sweden) was used, hereafter referred to as COMSOL. In the simulations the multifrontal massively parallel sparse direct solver MUMPS was applied.

A 2D axisymmetric geometry was applied. The 3D rotation of the geometry and the applied mesh is shown in Figure 5 and Figure 6. A 2D mesh consisting of triangular elements was applied on the investigated geometry.

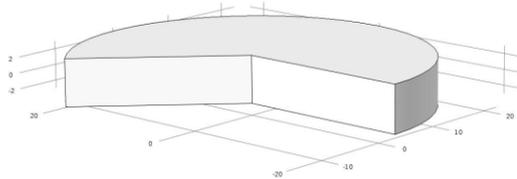

Figure 5. 3D rotation of the 2D axial symmetric geometry.

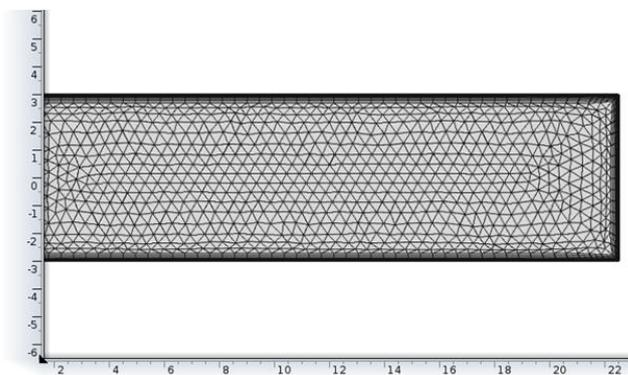

Figure 6. Mesh on the investigated geometry.

The element size was set using the predefined *extra fine* element size. To increase the resolution of the solution a boundary layer was added to the mesh with 4 rows and a growth factor of 1.2. The final number of elements was 2642. To ensure the mesh elements were sufficiently small a test simulation with the standard element size *extremely fine* (total elements 8482) was performed with the initial k_c and D value and equal boundary conditions for the mass flux. Comparing the calculated values for the center temperature and the average mass fraction the largest deviation, found for the center temperature at $t = 100s$, is 0.32% and the average deviations for the center temperature and mass fraction respectively are: 0.04% and $2.4 \cdot 10^{-5}$ %. With this very small variation the *extra fine* mesh was considered an acceptable resolution for the simulation work.

A build-in step function was used to incorporate a smooth transition from no-evaporation to evaporation at the boundaries. From the center temperature measurements (Figure 7) a plateau, indicating the initiation of evaporation is found close to $105^\circ C$. This value is in good concordance to findings described by (29) reporting that a plateau is generally observed around $103^\circ C$ in biscuit baking. The utilized step function increases from 0 to 1 over a pre-defined interval, initiating the mass flux at the boundaries. In the present work the applied transition interval was $105-110^\circ C$.

Optimizing the mass transfer and diffusion coefficients

The mass transfer and diffusion coefficients are only known approximately. Through optimization by comparison to the experimental data plausible and realistic values for these

coefficients are found. The optimization scheme is based on comparisons between the experimental data and matrices of 100 simulations. The 100 simulations are combinations of 10 k_c and 10 D values. In COMSOL these simulations are generated through a "parameter sweep" with two variables. The k_c and D values were distributed evenly on a logarithmic scale within the intervals given in Table 3.

Table 3. Investigated intervals for k_c and D .

C	Intervals	
	k_c (m/s)	D (m ² /s)
1.0	$1.78 \cdot 10^{-6} : 5.62 \cdot 10^{-5}$	$3.16 \cdot 10^{-5} : 1.00 \cdot 10^{-4}$
0.6	$5.62 \cdot 10^{-6} : 2.78 \cdot 10^{-5}$	$4.08 \cdot 10^{-5} : 6.81 \cdot 10^{-5}$
0.0	$5.62 \cdot 10^{-6} : 1.00 \cdot 10^{-4}$	$3.16 \cdot 10^{-5} : 1.00 \cdot 10^{-4}$

The error between the measurements and the simulation results are found as the total squared error for each simulation added for all the measuring points following Equation (14). Error values are calculated for the center temperature and the mass loss, respective. Additionally combined errors were found following Equation (15).

$$\epsilon = \sum_{n=1}^N (x_{n,\text{sim}} - x_{n,\text{exp}})^2 \quad (14)$$

where $x_{n,\text{sim}}$ is the simulated value, $x_{n,\text{exp}}$ is the experimental value and N the number of time steps.

$$\epsilon_{\text{combined}} = \epsilon_M \cdot \epsilon_T \quad (15)$$

where $\epsilon_{\text{combined}}$ is the combined error for both the center temperature and the mass loss, ϵ_M the total error for the mass loss, and ϵ_T the total error for the center temperature. Following this optimization scheme three values are calculated for each combination of k_c and D values. Three optimum combinations of k_c and D are thus available for each simulation set-up.

Results and Discussion

Experimental work

A total of 14 valid datasets were obtained for the center cookie temperature. The temperature measurements are shown in Figure 7 along with the average value plus and minus one standard deviation. The mass loss is shown as the mass fraction for the three averages of 12 cookies in Figure 8.

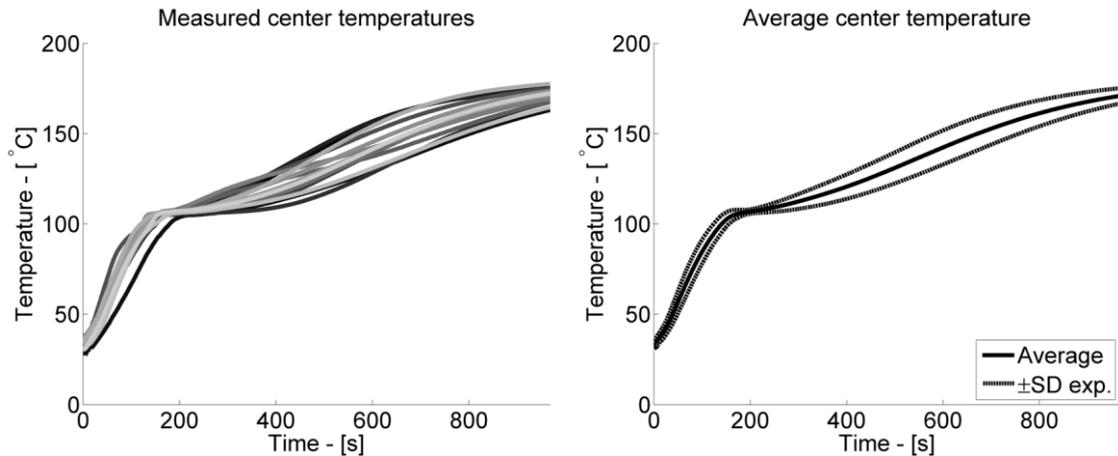

Figure 7. 7a: All 14 center temperature measurements. 7b: The average center temperature plus and minus one standard deviation.

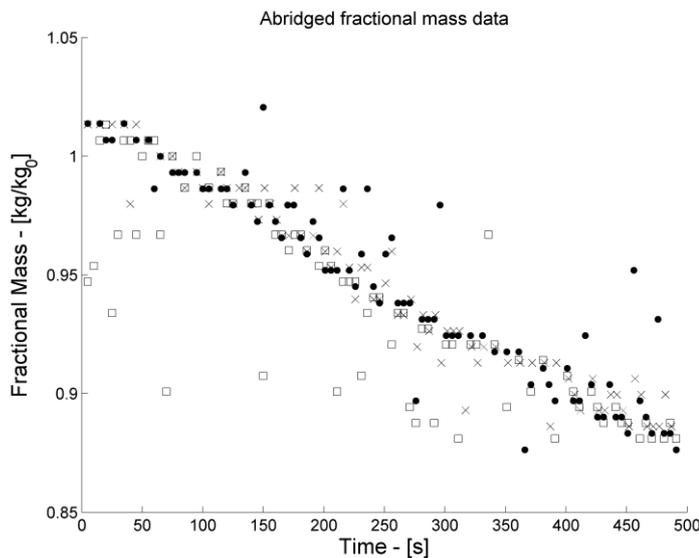

Figure 8. Mass fraction measurements.

Simulation results

The initial simulations were made for the symmetrical set-up with $C = 1.0$ in Equation (7b). Due to an unacceptable poor fit of the initial simulations the mass transfer and diffusion coefficients were optimized as described. The initial simulations showed close to no evaporation and no temperature increase over 105°C , showing inconsistent physical behavior of the model with the applied parameters. For improved simulations it was estimated that a higher diffusion coefficient was needed and possibly a higher mass transfer coefficient. Using parameter sweeps the mass transfer and diffusion coefficients were optimized in the subsequent simulations as described above.

The k_c and D intervals applied in each of the three parameter sweeps are shown in Table 3. The intervals for the symmetrical simulation were based on values reported for comparable bakery products and a number of test simulations. For biscuit products diffusion coefficients around $2 \cdot 10^{-5} \text{ m}^2/\text{s}$ for water vapor and $1.1 \cdot 10^{-5} \text{ m}^2/\text{s}$ for liquid water were reported by Hadiyanto et al. (3), for bread products a water vapor diffusion coefficient of $8 \cdot 10^{-7} \text{ m}^2/\text{s}$ and a liquid water diffusion coefficient of $1.35 \cdot 10^{-10} \text{ m}^2/\text{s}$ were reported by (20). Based on the initial simulation results with $D = 3.6 \cdot 10^{-8} \text{ m}^2/\text{s}$, it was found that a diffusion

coefficient in the range of water vapor for biscuit products is the most likely description for the mass transfer in the investigated butter cookies.

The investigated interval for the mass transfer coefficient was selected to include values both above and below the initial estimate of $k_c = 2.7 \cdot 10^{-6}$ m/s.

For the $C = 0.0$ set-up the diffusion coefficient interval was maintained from the symmetrical case ($C = 1.0$), and the k_c interval expanded to maintain a constant total mass loss through the smaller evaporation area.

For the $C = 0.6$ set-up the intervals were chosen based on the best fits obtained in the two preceding set-ups, which were used to narrow the investigated intervals.

The k_c and D values given in Table 4 were found to give the best fit for the three investigated set-ups. For each set-up three sets of values are given, the first two corresponding to the smallest errors comparing simulations and experimental data for the temperature and the weight loss measurements ($\epsilon_{\min,T}$ and $\epsilon_{\min,M}$), calculated from Equation (13), and the third set corresponding to the smallest combined error ($\epsilon_{\min,combi}$), calculated from Equation (14). The smallest calculated errors are also given in the table.

Table 4. k_c and D values corresponding to the lowest temperature, mass fraction or combined error for each of the three set-ups (the C value indicates the factor introduced in Equation (7b)).

	C = 1.0			C = 0.6			C = 0.0		
	ϵ value	k_c (m/s)	D (m ² /s)	ϵ value	k_c (m/s)	D (m ² /s)	ϵ value	k_c (m/s)	D (m ² /s)
$\epsilon_{\min,T}$	$5.50 \cdot 10^{-3}$	$5.62 \cdot 10^{-6}$	$4.08 \cdot 10^{-5}$	$4.20 \cdot 10^{-3}$	$8.00 \cdot 10^{-6}$	$4.17 \cdot 10^{-5}$	$2.11 \cdot 10^{-2}$	$2.78 \cdot 10^{-5}$	$4.64 \cdot 10^{-5}$
$\epsilon_{\min,M}$	$4.97 \cdot 10^{-2}$	$1.21 \cdot 10^{-5}$	$5.27 \cdot 10^{-5}$	$4.98 \cdot 10^{-2}$	$1.62 \cdot 10^{-5}$	$5.17 \cdot 10^{-5}$	$4.97 \cdot 10^{-2}$	$2.02 \cdot 10^{-5}$	$6.81 \cdot 10^{-5}$
$\epsilon_{\min,combi}$	$4.57 \cdot 10^{-4}$	$8.25 \cdot 10^{-6}$	$4.64 \cdot 10^{-5}$	$3.68 \cdot 10^{-4}$	$9.55 \cdot 10^{-6}$	$4.40 \cdot 10^{-5}$	$2.04 \cdot 10^{-3}$	$2.78 \cdot 10^{-5}$	$4.64 \cdot 10^{-5}$

The results show that for all three set-ups the model is capable of describing the total mass loss over time. Good agreement was seen between the center temperature measurements and the simulations for $C = 1.0$ and 0.6 . For $C = 0.0$ the model did not provide a good simulation of the center temperature. These results are supported by the error values shown in Table 4.

Comparing to the literature values reported above the optimized values for k_c and D appear reasonable. The values for k_c increase as the evaporation from the bottom surface are decreased. This is consistent with a higher mass flux from the free surfaces as the total evaporation is maintained. The D values indicate a high degree of water vapor transport inside the product, and are close to the value presented by Hadiyanto et al. (3) of $2 \cdot 10^{-5}$ m²/s for water vapor transport in biscuits.

In the optimization step the parameters are either optimized against the temperature measurements or the mass-loss data. The simulations optimized with regard to e.g. the center temperature are compared to the mass-loss data, and vice versa (the comparisons are shown in the graphs in Figure 9). The simulations, optimized with regard to the center temperature, did not result in acceptable agreement with the mass-loss data. However the solution optimized with regard to the mass-loss data provided acceptable simulations of the temperature in the $C = 1.0$ and $C = 0.6$ set-ups. In these two set-ups the center temperature was within or very close to one standard deviation from the average measured values throughout the baking process. For future work, optimization based on mass-loss data followed by validation against temperature measurements, may be a suitable method for parameter estimation.

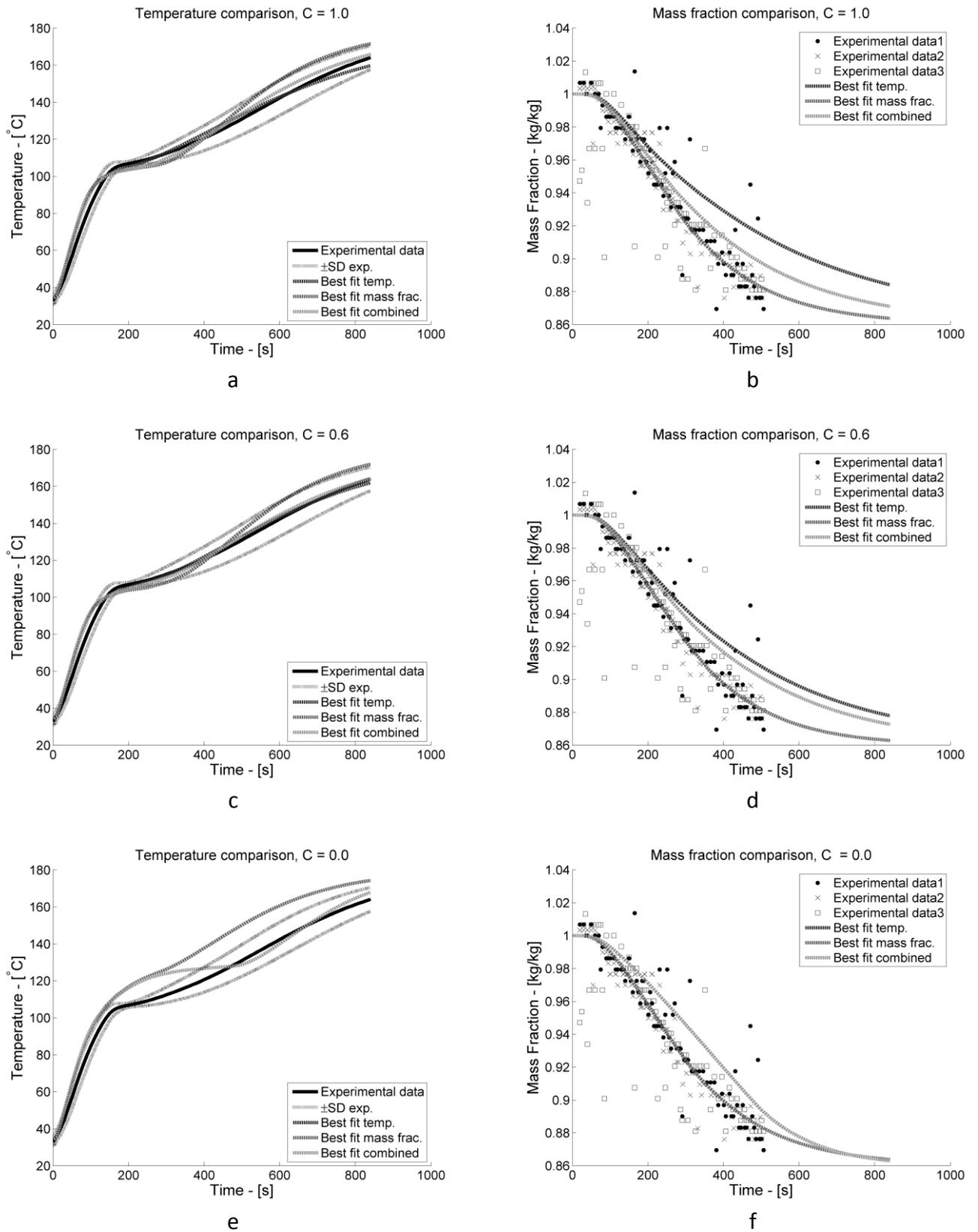

Figure 9. 9a and 9b: Simulation results for the symmetrical case ($C = 1.0$). 9c and 9d: Simulation results for the asymmetrical case with some mass transfer from the bottom surface ($C = 0.6$). 9e and 9f: Simulation results for the asymmetrical case with no mass transfer from the bottom surface ($C = 0$). The simulation results corresponding to best fit for the temperature, the mass fraction, and the smallest combined error are shown in each graph.

Conclusion

A unique advanced pilot batch oven was used to continuously measure the center temperature and the mass loss of butter cookies during baking, emulating the process conditions of an industrial tunnel oven. The data were then combined with a FEM physically based model for the heat and mass transfer during baking.

The model was seen to give a qualitatively good representation of the baking process. Comparing three set-ups it was concluded that the symmetrical set-up ($C = 1.0$), with equal evaporation from all surfaces is an acceptable description when heat and mass transfer inside the product is considered. The intermediate set-up ($C = 0.6$) with limited evaporation from the bottom surface provided a slightly better result compared to the symmetrical case. The set-up with no evaporation from the bottom surface ($C = 0.0$) did not give a good representation of the temperature development. However it was possible with all three set-ups to obtain good agreement between the simulated and measured over-all mass loss.

Calculating the development in temperature with parameters optimized to over-all mass loss leads to acceptable results for $C = 1.0$ and 0.6 , but not for $C = 0.0$. While mass-loss calculations based on the parameters optimized with regard to the center temperature do not render acceptable results in any of the three set-ups. Thus of the two measured product properties, optimization with the applied scheme should focus on reaching good agreement between the simulated and measured mass-loss data.

From the parameter optimization the values of the diffusion coefficients indicate a high degree of water vapor transport inside the cookie product during baking. The high diffusion coefficients are interesting with regard to the interior transport mechanisms. For all investigated set-ups good results were obtained for the average mass loss. This may be connected to high diffusion coefficients minimizing the effect of covered surfaces on the overall movement and removal of water. The good agreement between the symmetrical simulation set-up and the experimental measurements indicates a small effect of the baking tray on the over-all mass loss. While further investigation of other characteristics of the product are needed, the center temperature and over-all mass-loss is not likely to be affected by baking on either a perforated or meshed baking tray, compared to a steel sheet plate.

The results show good agreement between the continuously obtained measurements and simulations using an advanced modeling tool. For future work the applicability of the model could be broadened and refined in order to capture the full influence of the covered surfaces on the product properties and quality. This could be implemented through additional optimization using datasets containing information such as surface browning or surface temperature.

Acknowledgements

The authors would like to thank the Danish Ministry of Food, Agriculture and Fisheries for financially supporting the presented research (J.no. 3414-08-02280).

References:

1. Andresen MS, Risum J, Adler-Nissen J, Design and construction of a batch oven for investigation of industrial continuous baking processes. *J. Food Process Eng.* Accepted for publication 2012.
2. Feyissa AH, Gernaey KV, Ashokkumar S, Adler-Nissen J. Modelling of coupled heat and mass transfer during a contact baking process. *J. Food Eng.* 2011;106(3):228-35.
3. Hadiyanto, Asselman A, Straten GV, Boom RM, Esveld DC, Boxtel, AJBV. Quality prediction of bakery products in the initial phase of process design. *Innovative Food Sci. Emerging Technol.* 2007;8(2):285-298.
4. Purlis E, Salvadori V. Bread Baking as a Moving Boundary Problem. Part 1: Mathematical Modelling. *J. Food Eng.* 2009; 91: 428-33.
5. Purlis E, Salvadori V. Bread Baking as a Moving Boundary Problem. Part 2: Model Validation and Numerical Simulation. *J. Food Eng.* 2009; 91: 434-42.
6. Sablani S, Marcotte M, Baik O, Castaigne F. Modeling of Simultaneous Heat and Water Transport in the Baking Process. *LWT-Food Sci. Technol.* 1998; 31: 201-9.
7. Sakin-Yilmazer M, Kaymak-Ertekin F, Ilicali C. Modeling of simultaneous heat and mass transfer during convection oven ring cake baking. *J. Food Eng.* 2012; 111: 289-98.
8. Thorvaldsson K, Skjöldebrand C. Water diffusion in bread during baking. *Lebensm.-Wiss. Technol.* 1998; 31: 658-63.
9. Wählby U. Heat and mass transfer in impingement cooking aspects of food quality [dissertation]. Chalmers Tekniska Högskola; 2002.
10. Sakin M, Kaymak-Ertekin F, Ilicali C. Modeling the moisture transfer during baking of white cake. *J. Food Eng.* 2007; 80(3): 822-831.
11. Purlis E. Baking Process Design Based on Modelling and Simulation: Towards Optimization of Bread Baking. *Food Control.* 2012; 27(1): 45-52.
12. Ferrari E, Marai SV, Guidetti R, Piazza L. Modelling of Heat and Moisture Transfer Phenomena During Dry Biscuit Baking by Using Finite Element Method. *Int. J. Food Eng.* 2012;8(3): 2326.
13. Demirkol E, Erdogdu F, Palazoglu T. Analysis of mass transfer parameters (changes in mass flux, diffusion coefficient and mass transfer coefficient) during baking of cookies. *J. Food Eng.* 2006;72:364-71.
14. Olszewski EA. From Baking a Cake to Solving the Diffusion Equation. *Am. J. Phys.* 2006; 74(6): 502-9.
15. Mondal A, Datta AK. Two-Dimensional CFD Modeling and Simulation of Crustless Bread Baking Process. *J. Food Eng.* 2010; 99(2): 166-74.
16. Ploteau JP, Nicolas V, Glouannec P. Numerical and Experimental Characterization of a Batch Bread Baking Oven. *Appl. Therm. Eng.* 2012; 48: 289-95.
17. Chen H. Modeling coupled heat and mass transfer for convection cooking of chicken patties. *J. Food Eng.* 1999;42:139-46.
18. Mondal A, Datta AK. Bread baking - A review. *J. Food Eng.* 2008;86:465-74.
19. Purlis E. Browning development in bakery products - a review. *J. Food Eng.* 2010; 99(3): 239-49.
20. Thorvaldsson K, Janestad H. A model for simultaneous heat, water and vapour diffusion. *J. Food Eng.* 1999; 40: 167-172.
21. Bird R, Stewart W, Lightfoot E. *Transport phenomena*, 2nd ed. John Wiley & Sons; 2002.

22. Choi Y, Okos MR. Effects of temperature and composition on the thermal properties of foods. *Food Eng. and Proc. App. Proceedings of the 4th int. cong. on Eng. and Food at Edmonton Alberta Canada*, Elsevier Applied Science Publishers. 1986;93-101.
23. Fricke BA, Becker BR. Evaluation of Thermophysical Property Models for Foods. *HVAC&R Res.* 2001;7(4):311-30.
24. Carson J, Willix J, North M. Measurements of heat transfer coefficients within convection ovens. *J. Food Eng.* 2006;72:293-301.
25. Mills A. Basic heat transfer, The Richard D. Irwin series in heat transfer. Irwin; 1995.
26. Nitin N, Karwe MV. Heat transfer coefficient for cookie shaped objects in a hot air jet impingement oven. *J. Food Process Eng.* 2001; 24: 51-69.
27. Achenbach E. The effect of surface roughness on the heat transfer from a circular cylinder to the cross flow of air. *Int. J. Heat Mass Transfer.* 1977;20(4):359-69.
28. Thorvaldsson K, Janestad H. A model for simulateneous heat, water and vapour diffusion. *J. Food Eng.* 1999; 40: 167-172.
29. Mowbray WR. Technology of the "hot box". *Food Manuf.* 1981; 56: 27-30.

Appendix G

Literature search for state of the art articles

In the following a short summary of the search criteria used to identify state of the art articles is presented. The two focus areas of the literature search were heat and mass transfer modeling and experimental ovens.

G.1 Search targeted towards mathematical modeling in bakery products

Three combinations of keywords were used to find articles on heat and mass transfer modeling in bakery products. The investigated groups of bakery products were specified to include bread, cookies, biscuits, crackers, and cakes. Using the Boolean operator OR all articles including one or more of these products in combination with the remaining keywords will appear in the search results. The three search criteria and number of results obtained through DTU Library are summarized in the following:

- Search 1: *heat AND mass AND baking AND (bread OR cookie OR biscuit OR cracker OR cake)*; Results in 183 hits¹. Some hits recommended by Christina Skjoldebrand are found around 2002-2003.
- Search 2: *(modelling OR modeling) AND baking AND (bread OR biscuit OR cracker OR cake)*; Results in 358 hits². It is difficult from a quick overview to see if there is a significant distinction between the relevant hits within these results compared to Search 1. From the results in Search 1 the second search does not seem necessary. A wide selection of examples of heat and mass transfer modeling in bakery products are found from Search 1.

¹May 3rd, 2013

²May 3rd, 2013

- Search 3: “*baking AND oven AND continuous*”; results in 208 results³. In contrast to Search 1 and 2 this search was focused on continuous baking processes.

As a double check that the most important articles were found the same combinations of keywords were used to search in the database Web of Science. The same or fewer results were obtained through Web of Science, e.g. the search on *Web of Science: “baking AND oven AND continuous”* results in 29 results⁴, of which all were found through DTU Library.

A 4th search combination was carried out for the keywords “*experimental AND controlled AND baking*”. This combination did not result in additional relevant results.

G.2 Search for experimental ovens

From the different combinations of search words which have been used, it was found that it is difficult to locate experimental ovens applied for model validation. Therefore wider search criteria were used to identify articles about experimental ovens. From the search with the keywords: “*baking AND (experimental OR experiment OR pilot) AND oven*” a total of 206 results were found⁵. When recurrences and irrelevant articles were removed a total of 96 articles were left. From these 96 articles only 9 were found to include a reference to pilot or experimental ovens in the title (due to language barriers 6 were acquired and studied for further evaluation). Additionally a number of articles were relevant for the study of improving baking conditions in continuous tunnel ovens and comparison between tunnel and batch ovens. In total 9 of the 206 results could be directly linked to either optimization of industrial tunnel ovens, scaling between pilot and full scale ovens, or describing experimental equipment considering the title of the article alone.

Articles including experimental ovens were indirectly found from the search considering modeling work. The ovens presented in these articles along with articles known to present ovens for experimental work, even though they did not appear in the search results, are included in the state of the art review for experimental baking equipment (Section 2.3.2).

³May 3rd, 2013

⁴May 7th, 2013

⁵May 3rd, 2013

Appendix H

Literature review for quality assessment

In this appendix an overview of the investigated articles used in Chapter 4 is given. Figure H.1 shows how the articles are distributed by year of publishing. In Table H.1 more details are given, specifying which quality assessment groups have been used in each article.

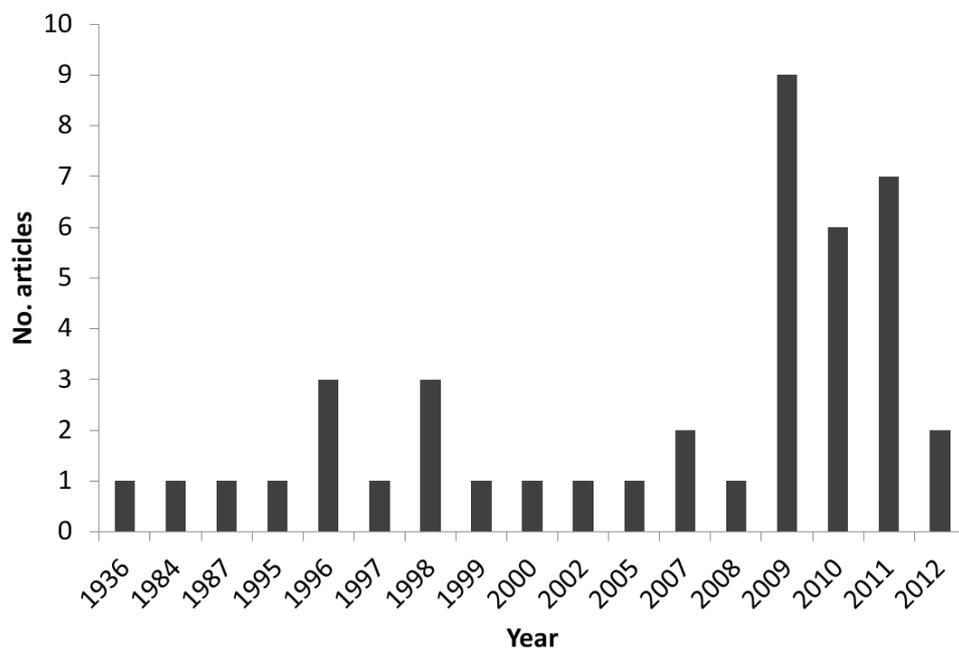

Figure H.1: Distribution of investigated articles by publishing year.

Table H.1. Overview of the articles related to quality assessment.

Year	Cookie	Cracker	Biscuit	Physical/dimensions	Appearance	Texture	Composition	Rheology	Reference
1936			X	X		X			23
1984	X			X					103
1987			X				X		49
1995			X	X					104
1996	X				X				105
1996	X			X			X		48
1996			X		X				18
1997			X	X					106
1998		X			X		X		28
1998			X	X		X			39
1998			X	X					107
1999			X	X	X	X			27
2000	X			X	X	X	X		43
2002			X				X		47
2005	X			X		X			42
2007	X			X					108
2007	X			X		X			37
2008	X			X					109
2009	X			X					19
2009			X				X		110
2009	X			X	X	X			35
2009	X			X	X	X			36
2009	X			X	X				114
2009	X			X					20
2009	X			X	X				29
2009	X			X					61
2009	X			X	X	X	X		30
2010	X			X	X	X			21
2010			X	X		X	X		44
2010			X	X	X	X	X	X	17
2010	X			X		X	X		40
2010	X			X	X				32
2010	X			X	X	X			22
2011			X	X			X		46
2011	X			X	X		X		33
2011		X		X		X	X		38
2011	X						X		50
2011	X			X					111
2011	X			X					112
2011			X	X		X			41
2012	X			X					113
2012			X		X		X		34
Total	25	2	15	34	16	16	15	1	

Appendix I

ANOVA testing influence of air flow

This chapters shows the results of the ANOVA used for testing variations in mass loss and browning when baking at five different inlet air velocities in the new batch oven (cf. Chapter 6). 18 repetitions were carried out at each of the five inlet air settings.

Data and ANOVA test for weight loss after 8 min of baking at five different inlet air settings.

Repetitions	Mass fraction				
	Set = 1	Set = 3	Set = 5	Set = 7	Set = 9
1	0.8881	0.8850	0.8799	0.8796	0.8789
2	0.8879	0.8825	0.8827	0.8791	0.8782
3	0.8851	0.8824	0.8832	0.8815	0.8784
4	0.8865	0.8833	0.8818	0.8788	0.8779
5	0.8892	0.8829	0.8840	0.8813	0.8798
6	0.8904	0.8846	0.8894	0.8799	0.8788
7	0.8895	0.8851	0.8784	0.8802	0.8780
8	0.8873	0.8817	0.8756	0.8776	0.8752
9	0.8869	0.8822	0.8750	0.8793	0.8815
10	0.8910	0.8825	0.8808	0.8790	0.8762
11	0.8848	0.8831	0.8810	0.8806	0.8762
12	0.8875	0.8824	0.8796	0.8804	0.8776
13	0.8865	0.8804	0.8880	0.8788	0.8771
14	0.8878	0.8792	0.8871	0.8767	0.8764
15	0.8861	0.8813	0.8853	0.8762	0.8784
16	0.8855	0.8832	0.8785	0.8776	0.8767
17	0.8853	0.8835	0.8817	0.8813	0.8805
18	0.8845	0.8848	0.8840	0.8793	0.8781

Anova: Single Factor

SUMMARY

Groups	Count	Sum	Average	Variance
Set = 1	18	15.9699	0.8872	3.65E-06
Set = 3	18	15.8901	0.8828	2.44E-06
Set = 5	18	15.8760	0.8820	1.56E-05
Set = 7	18	15.8272	0.8793	2.34E-06
Set = 9	18	15.8039	0.8780	2.54E-06

ANOVA

Source of variance	SS	df	MS	F	P-value	F crit
Between Groups	0.00092	4	0.00023	43.28222	9.27E-20	2.479015
Within Groups	0.000452	85	5.31E-06			
Total	0.001372	89				

Data and ANOVA test for L* values after 8 min of baking at five different inlet air settings.

Repetition	Average L*				
	Set = 1	Set = 3	Set = 5	Set = 7	Set = 9
1	79	78	77	73	74
2	78	76	76	74	73
3	79	77	76	75	73
4	79	78	77	73	72
5	78	77	77	75	73
6	78	77	75	75	74
7	79	78	76	76	72
8	79	76	77	76	69
9	79	76	76	74	69
10	79	78	74	74	72
11	79	79	77	75	73
12	78	78	78	78	73
13	79	78	77	74	73
14	78	76	74	73	73
15	79	77	74	74	73
16	79	77	76	74	73
17	78	79	76	75	74
18	79	78	78	76	76

Anova: Single Factor

SUMMARY

Groups	Count	Sum	Average	Variance
Set = 1	18	1416.85	78.71	0.3008321
Set = 3	18	1391.83	77.32	1.01670752
Set = 5	18	1372.64	76.26	1.59549386
Set = 7	18	1344.47	74.69	1.63187393
Set = 9	18	1309.68	72.76	2.76739477

ANOVA

Source of variance	SS	df	MS	F	P-value	F crit
Between Groups	384.830317	4	96.2075793	65.7847399	3.1329E-25	2.479015
Within Groups	124.309137	85	1.46246044			
Total	509.139454	89				

Appendix J

Parameters and variables for COMSOL simulations

The constant and variable parameters used in the COMSOL simulations are listed in Table J.1.

Table J. Overview of parameters used in COMSOL simulations, the values correspond to the limited mass transfer case described in Chapter 9.

Name	Expression	Description
Constant parameters:		
height	6[mm]	Cookie height
radius	22.5[mm]	Radius of cookie
area	$2 \cdot \pi \cdot \text{radius}^2 + 2 \cdot \pi \cdot \text{radius} \cdot \text{height}$	Total surface area
volume	$\pi \cdot \text{radius}^2 \cdot \text{height}$	Total cookie volume
x_w	0.14[kg/kg]	Water content in dough
x_dm	0.86[kg/kg]	Dry matter content in dough
m_0	12.4[g]	Initial cookie weight
m_w0	$x_w \cdot m_0$	Initial mass of water in a cookie
T_air	180[degC]	Oven air temperature
T0	34[degC]	Initial product temperature
h_T	62.9[W/(m ² *K)]	Heat transfer coefficient
c0	$m_w0/M_{H2O}/\text{volume}$	Initial moisture concentration
k_c	6.8129e-5[m/s]	Optimized mass transfer coefficient
k_cinit	2.7e-6[m/s]	Initial tested mass transfer coefficient
D	7.7426e-8[m ² /s]	Optimized diffusion coefficient
Dinit	3.6e-8[m ² /s]	Initial tested diffusion coefficient
M_H2O	18[g/mol]	Molar weight of water
rho_dough	m_0/volume	Dough density
rho_water	993[kg/m ³]	Density of water at 30°C
lda	$2.3e6[\text{J}/\text{kg}] \cdot M_{H2O}$	Enthalpy for water evaporation
c_b	0[mol/m ³]	Air water concentration
Variable parameters:		
mt	$m_0 - M_{H2O} \cdot \text{volume} \cdot (c0 - c)$	Variable cookie weight
rho_cookie	mt/volume	Variable cookie density
k_T	$0.2101[\text{W}/(\text{m} \cdot \text{K})] + 0.6180[\text{W}/(\text{m} \cdot \text{K})] \cdot (m_w/mt) \dots$ $\dots / \text{rho_water} / (6.69448e-4 + (m_w/mt)/\text{rho_water})$	Thermal conductivity
c_p	$1.525[\text{kJ}/(\text{kg} \cdot \text{K})] + m_w/mt \cdot 4.180[\text{kJ}/(\text{kg} \cdot \text{K})]$	Specific heat capacity
m_w	$c \cdot M_{H2O} \cdot \text{volume}$	Mass of water

National Food Institute
Technical University of Denmark
Mørkhøj Bygade 19
DK - 2860 Søborg

Tel. 35 88 70 00
Fax 35 88 70 01

www.food.dtu.dk

ISBN: 978-87-92763-95-2